

AV RECEIVER/AV AMPLIFIER RX-V1900/HTR-6290/ DSP-AX1900 SERVICE MANUAL

RX-V1900/HTR-6290/
DSP-AX1900

IMPORTANT NOTICE

This manual has been provided for the use of authorized YAMAHA Retailers and their service personnel.

It has been assumed that basic service procedures inherent to the industry, and more specifically YAMAHA Products, are already known and understood by the users, and have therefore not been restated.

WARNING: Failure to follow appropriate service and safety procedures when servicing this product may result in personal injury, destruction of expensive components, and failure of the product to perform as specified. For these reasons, we advise all YAMAHA product owners that any service required should be performed by an authorized YAMAHA Retailer or the appointed service representative.

IMPORTANT: The presentation or sale of this manual to any individual or firm does not constitute authorization, certification or recognition of any applicable technical capabilities, or establish a principle-agent relationship of any form.

The data provided is believed to be accurate and applicable to the unit(s) indicated on the cover. The research, engineering, and service departments of YAMAHA are continually striving to improve YAMAHA products. Modifications are, therefore, inevitable and specifications are subject to change without notice or obligation to retrofit. Should any discrepancy appear to exist, please contact the distributor's Service Division.

WARNING: Static discharges can destroy expensive components. Discharge any static electricity your body may have accumulated by grounding yourself to the ground buss in the unit (heavy gauge black wires connect to this buss).

IMPORTANT: Turn the unit OFF during disassembly and part replacement. Recheck all work before you apply power to the unit.

CONTENTS

TO SERVICE PERSONNEL	2	DISPLAY DATA	71-72
FRONT PANELS	4	IC DATA	73-83
REAR PANELS	6-9	BLOCK DIAGRAMS	84-87
REMOTE CONTROL PANELS	10	PRINTED CIRCUIT BOARDS	88-119
SPECIFICATIONS / 参考仕様	11-16	PIN CONNECTION DIAGRAMS	120-122
INTERNAL VIEW	17	SCHEMATIC DIAGRAMS	123-144
DISASSEMBLY PROCEDURES / 分解手順	18-26	REPLACEMENT PARTS LIST	145-186
UPDATING FIRMWARE / ファームウェアの書き込み	27-33	REMOTE CONTROL	187-190
SELF-DIAGNOSTIC FUNCTION / ダイアグ (自己診断機能)	34-69	ADVANCED SETUP / 本機の設定を変更する	191-197
AMP ADJUSTMENT / アンプ部調整	70		



このサービスマニュアルは、エコマーク認定の再生紙を使用しています。
This Service Manual uses recycled paper.

101113

Copyright © 2008 YAMAHA CORPORATION All rights reserved.
This manual is copyrighted by YAMAHA and may not be copied or
redistributed either in print or electronically without permission.



YAMAHA

YAMAHA CORPORATION
P.O.Box 1, Hamamatsu, Japan

animate '08.09

■ TO SERVICE PERSONNEL

1. Critical Components Information

Components having special characteristics are marked Δ and must be replaced with parts having specifications equal to those originally installed.

2. Leakage Current Measurement (For 120V Models Only)

When service has been completed, it is imperative to verify that all exposed conductive surfaces are properly insulated from supply circuits.

- Meter impedance should be equivalent to 1500 ohms shunted by 0.15 μ F.

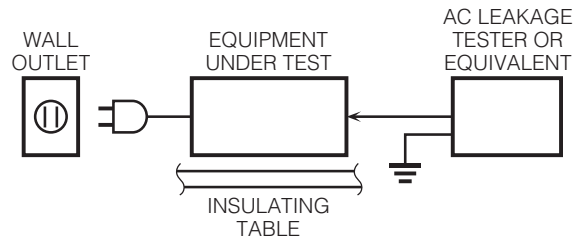

- Leakage current must not exceed 0.5mA.
- Be sure to test for leakage with the AC plug in both polarities.



“CAUTION”

“F1, F2: FOR CONTINUED PROTECTION AGAINST RISK OF FIRE, REPLACE ONLY WITH SAME TYPE 10A, 125V FUSE.”

CAUTION

F1, F2: REPLACE WITH SAME TYPE 10A, 125V FUSE.

ATTENTION

F1, F2: UTILISER UN FUSIBLE DE RECHANGE DE MÊME TYPE DE 10A, 125V.

WARNING: CHEMICAL CONTENT NOTICE!

This product contains chemicals known to the State of California to cause cancer, or birth defects or other reproductive harm.

DO NOT PLACE SOLDER, ELECTRICAL/ELECTRONIC OR PLASTIC COMPONENTS IN YOUR MOUTH FOR ANY REASON WHATSOEVER!

Avoid prolonged, unprotected contact between solder and your skin! When soldering, do not inhale solder fumes or expose eyes to solder/flux vapor!

If you come in contact with solder or components located inside the enclosure of this product, wash your hands before handling food.

About lead free solder / 無鉛ハンダについて

All of the P.C.B.s installed in this unit and solder joints are soldered using the lead free solder.

Among some types of lead free solder currently available, it is recommended to use one of the following types for the repair work.

- Sn + Ag + Cu (tin + silver + copper)
- Sn + Cu (tin + copper)
- Sn + Zn + Bi (tin + zinc + bismuth)

Caution:

As the melting point temperature of the lead free solder is about 30°C to 40°C (50°F to 70°F) higher than that of the lead solder, be sure to use a soldering iron suitable to each solder.

本機に搭載されているすべての基板およびハンダ付けによる接合部は無鉛ハンダでハンダ付けされています。

無鉛ハンダにはいくつかの種類がありますが、修理時には下記のような無鉛ハンダの使用を推奨します。

- Sn+Ag+Cu (錫 + 銀 + 銅)
- Sn+Cu (錫 + 銅)
- Sn+Zn+Bi (錫 + 亜鉛 + ビスマス)

注意：

無鉛ハンダの融点温度は通常の鉛入りハンダに比べ 30～40°C程度高くなっていますので、それぞれのハンダに合ったハンダごてをご使用ください。

WARNING: Lithium batteries**CAUTION**

Danger of explosion if battery is incorrectly replaced.
Replace only with the same or equivalent type.

WARNING: Lithium batteries are dangerous because they can be exploded by improper handling. Observe the following precautions when handling or replacing lithium batteries.

- Leave lithium battery replacement to qualified service personnel.
- Always replace with batteries of the same type.
- When installing on the PC board by soldering, solder using the connection terminals provided on the battery cells. Never solder directly to the cells. Perform the soldering as quickly as possible.
- Never reverse the battery polarities when installing.
- Do not short the batteries.
- Do not attempt to recharge these batteries.
- Do not disassemble the batteries.
- Never heat batteries or throw them into fire.

注意

正しい電池と交換しないと爆発が起きるおそれがあります。
同一型名または同等品以外の電池とは絶対に交換しないようにしてください。

ADVARSEL!

Lithiumbatteri –Eksplosionsfare ved fejlagtig håndtering.
Udskiftning må kun ske med batteri af samme fabrikat og type. Levér det brugte batteri tilbage til leverandøren.

VARNING

Explosionsfara vid felaktigt batteribyte. Använd samma batterityp eller en ekvivalent typ som rekommenderas av apparattillverkaren. Kassera använt batteri enligt fabrikan- tens instruktion.

VAROITUS

Paristo voi räjähtää, jos se on virheellisesti asennettu.
Vaihda paristo ainoastaan laitevalmistajan suosittelemaan tyyppiin. Hävitä käytetty paristo valmistajan ohjeiden mu- kaisesti.

FRONT PANELS

RX-V1900 (U model)

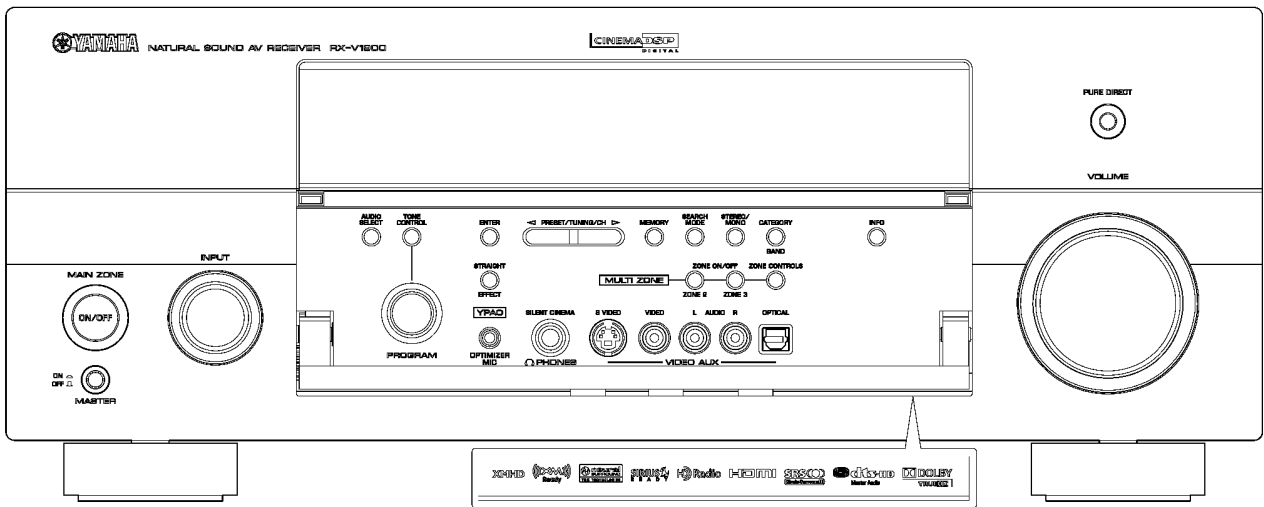

RX-V1900 (C model)

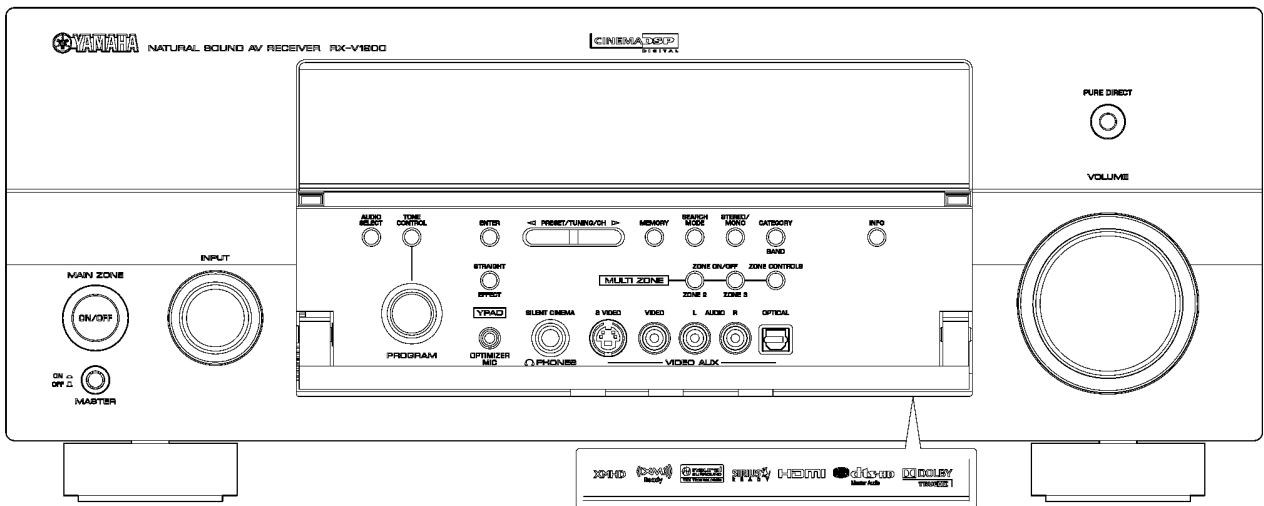

RX-V1900 (R, T, K, A, B, G, E, L models)

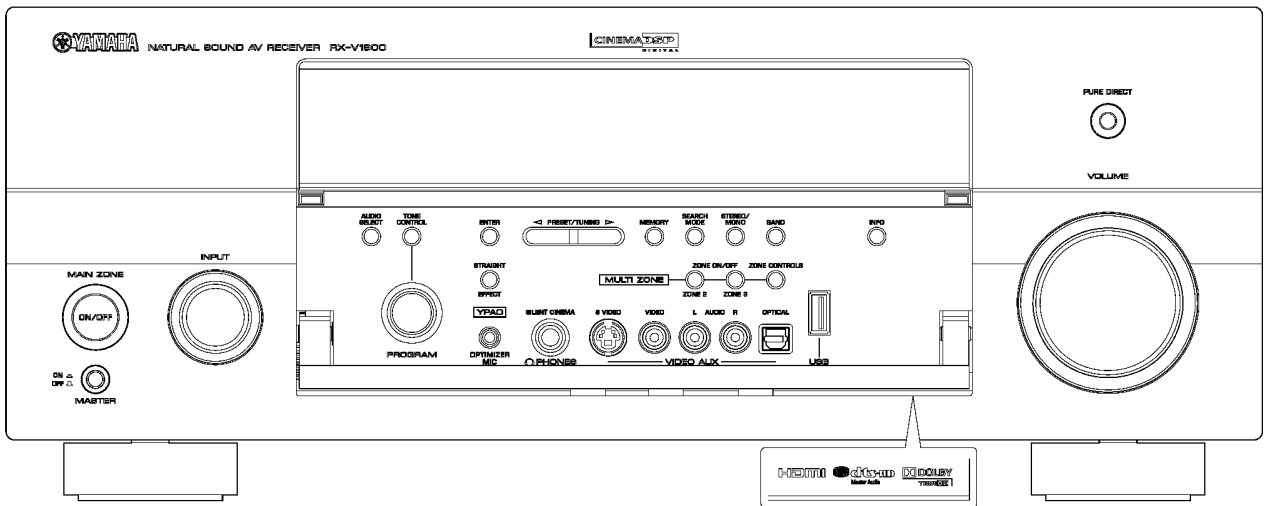

RX-V1900/HTR-6290/DSP-AX1900

HTR-6290 (C model)

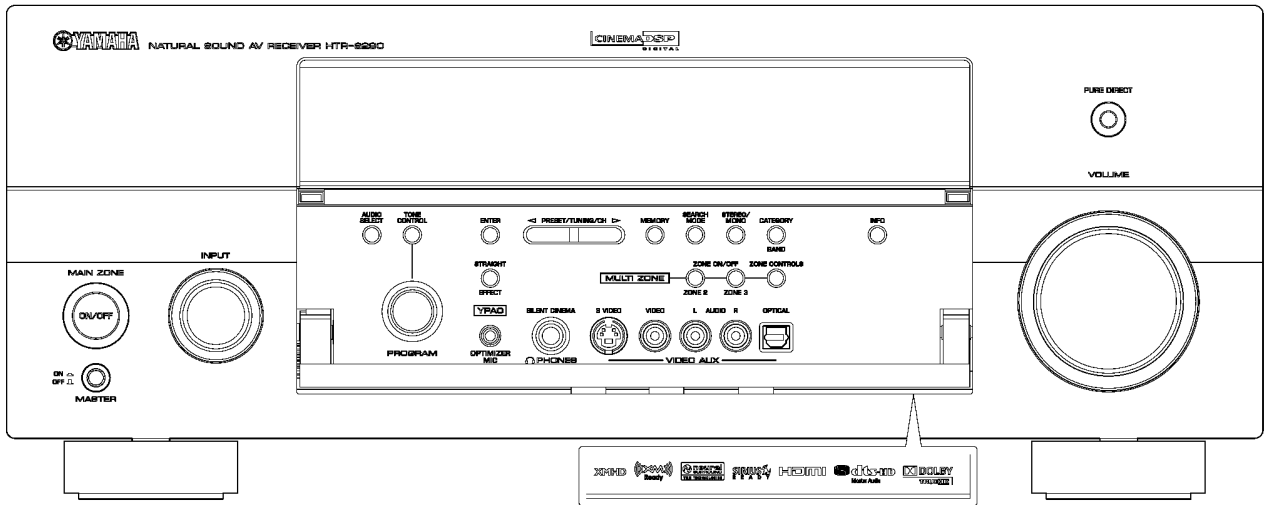

RX-V1900/HTR-6290/
DSP-AX1900

HTR-6290 (G model)

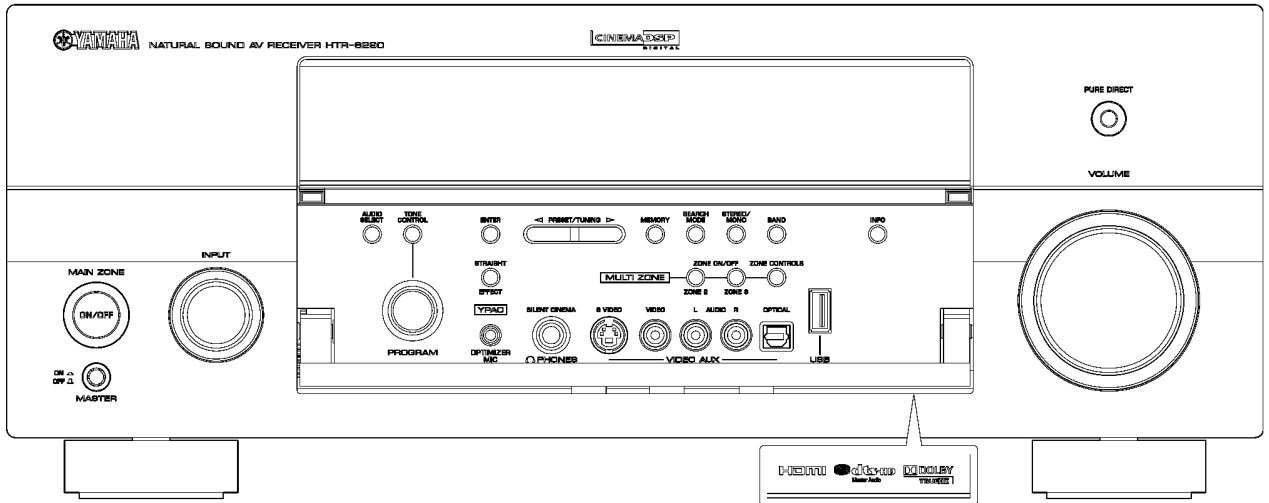

DSP-AX1900 (J model)

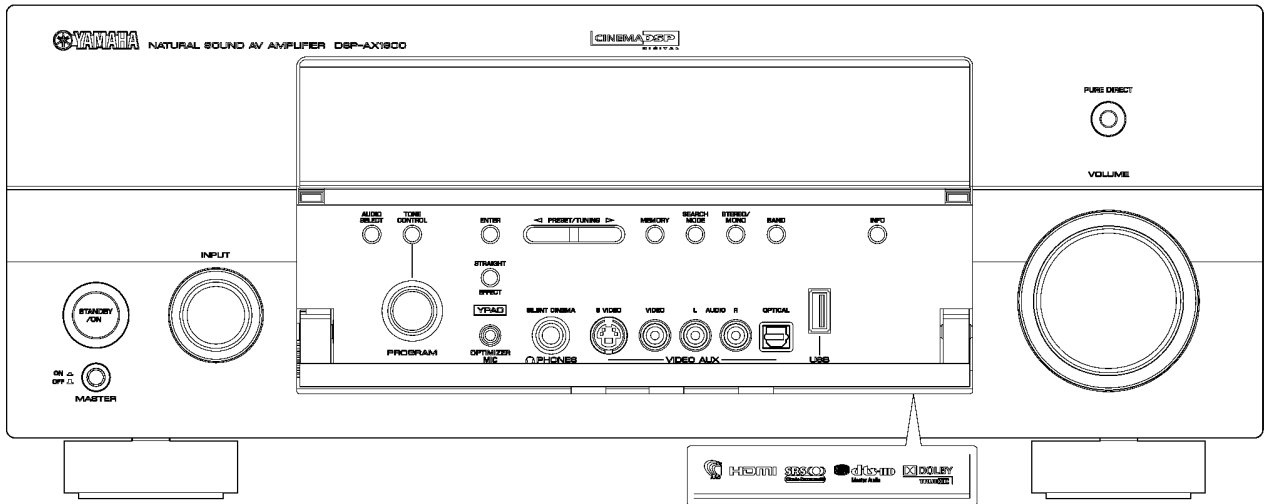

REAR PANELS

RX-V1900 (U model)

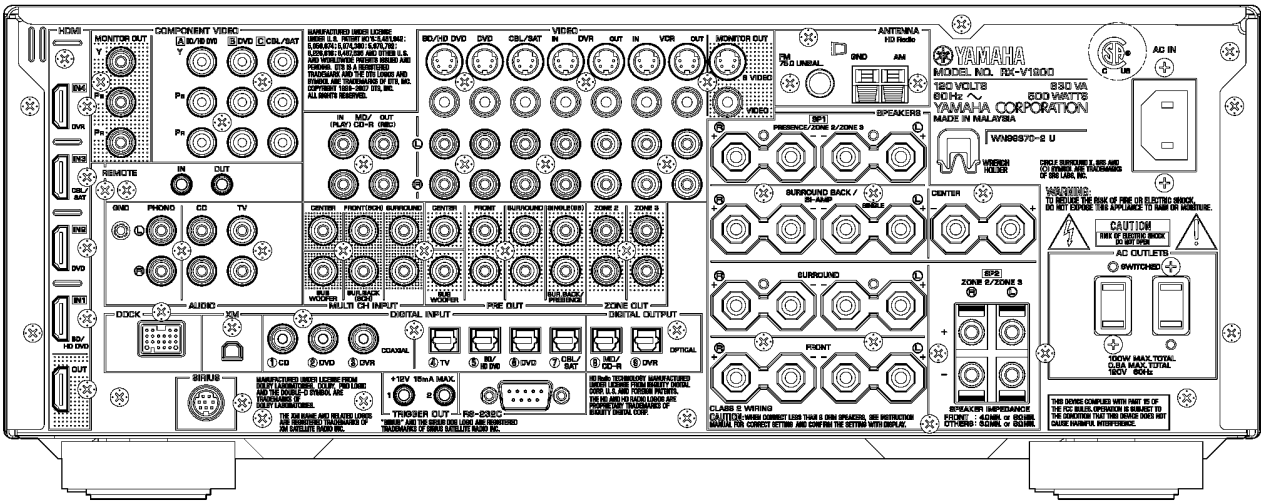

RX-V1900 (C model)

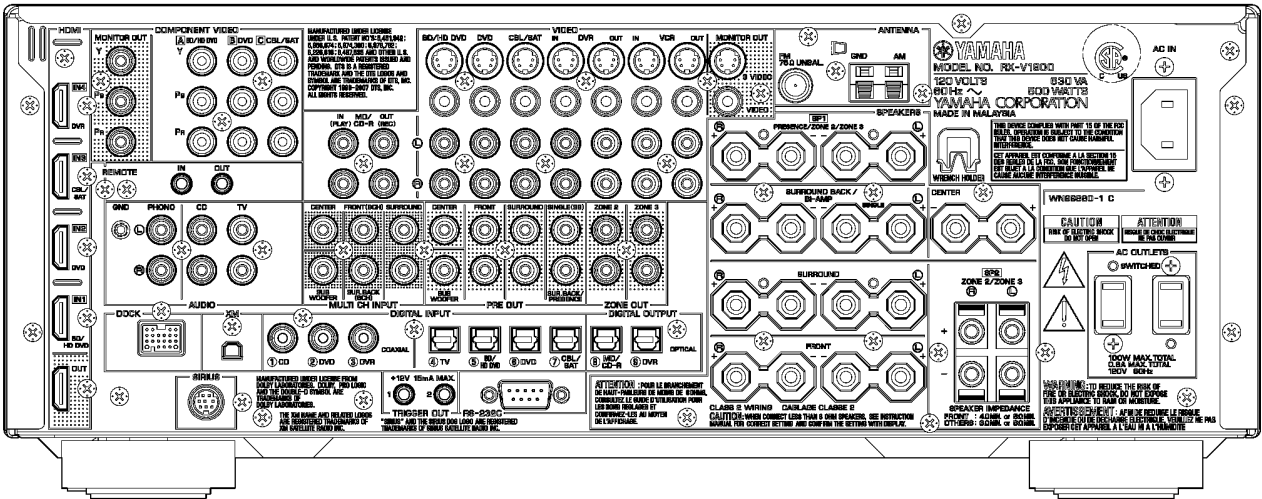

RX-V1900 (R model)

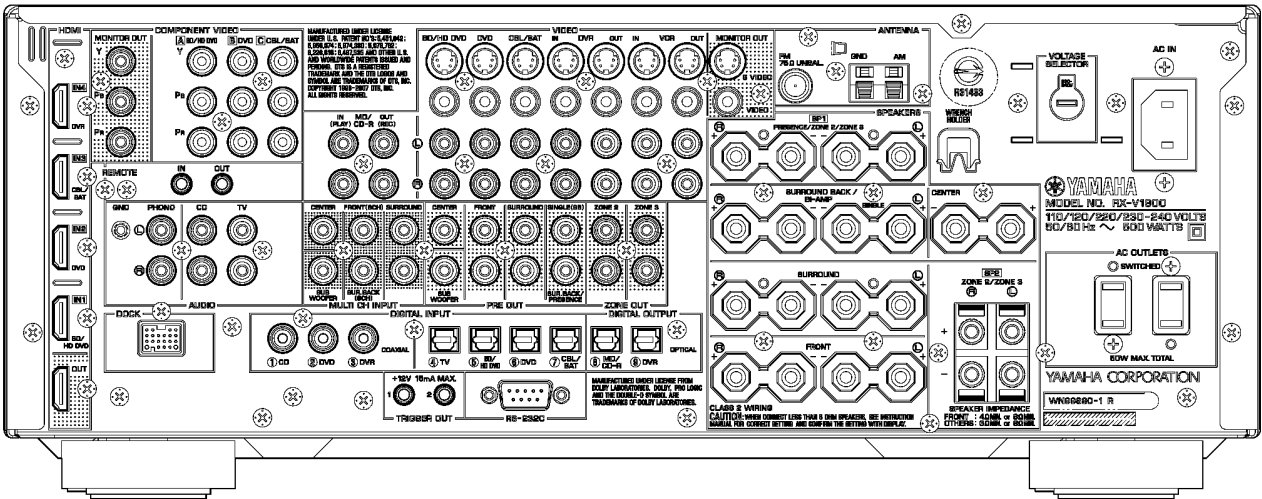

RX-V1900 (T model)

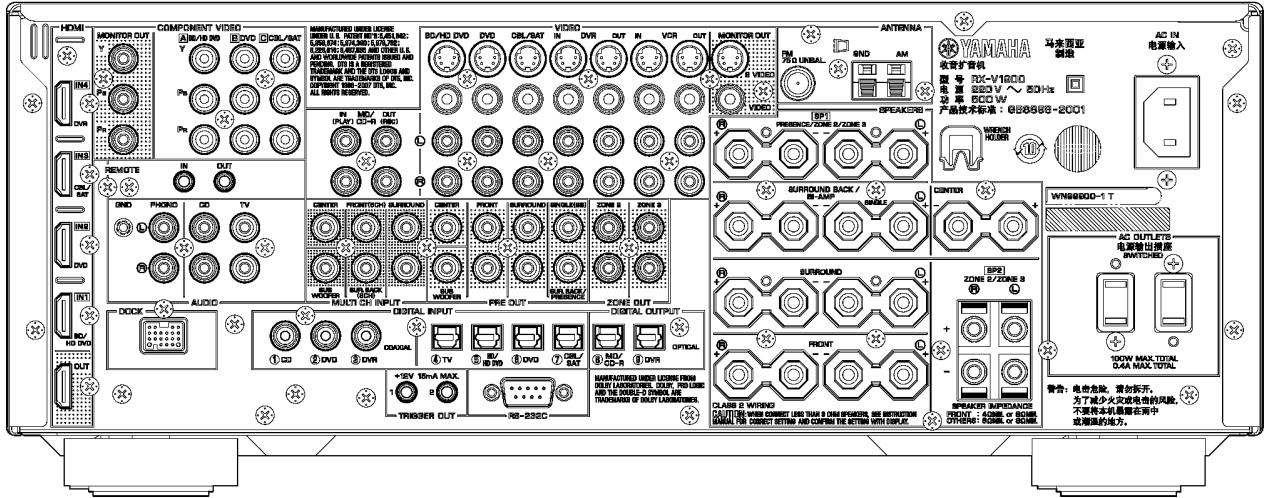

RX-V1900/HTR-6290/
DSP-AX1900

RX-V1900 (K model)

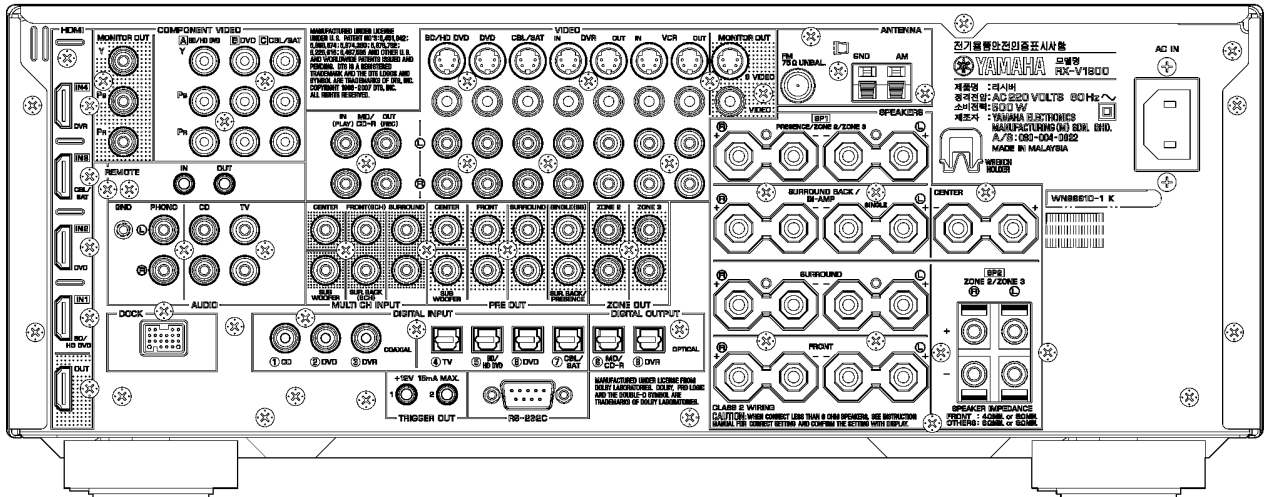

RX-V1900 (A model)

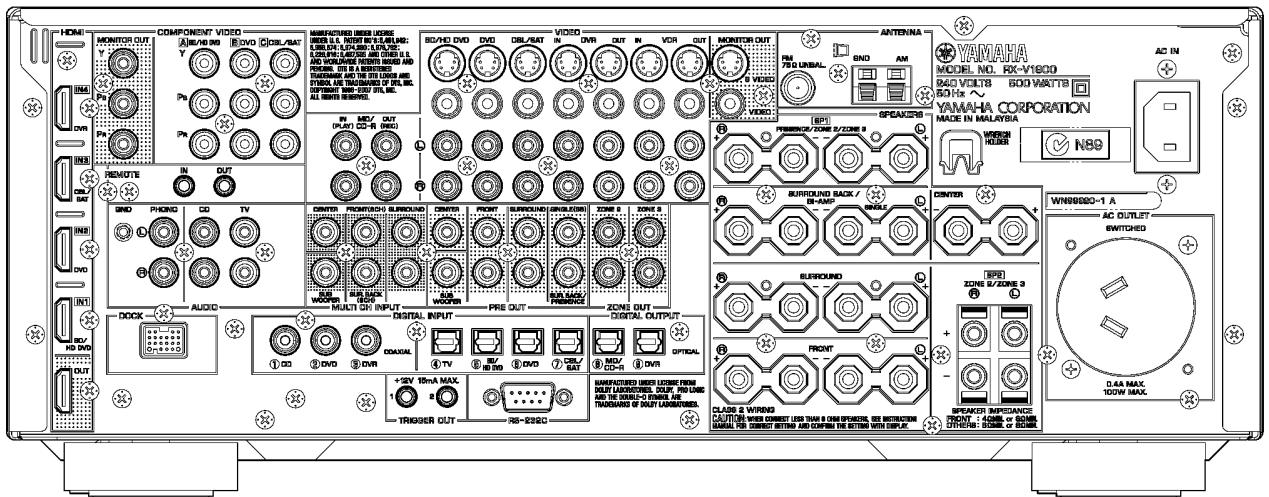

RX-V1900/HTR-6290/DSP-AX1900

RX-V1900 (B model)

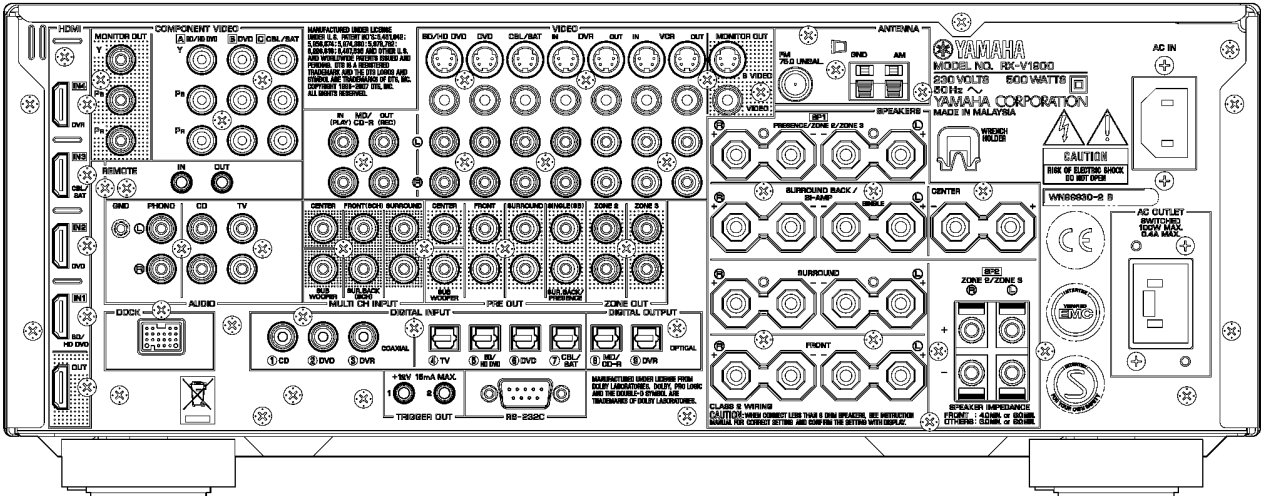

RX-V1900 (G, E models)

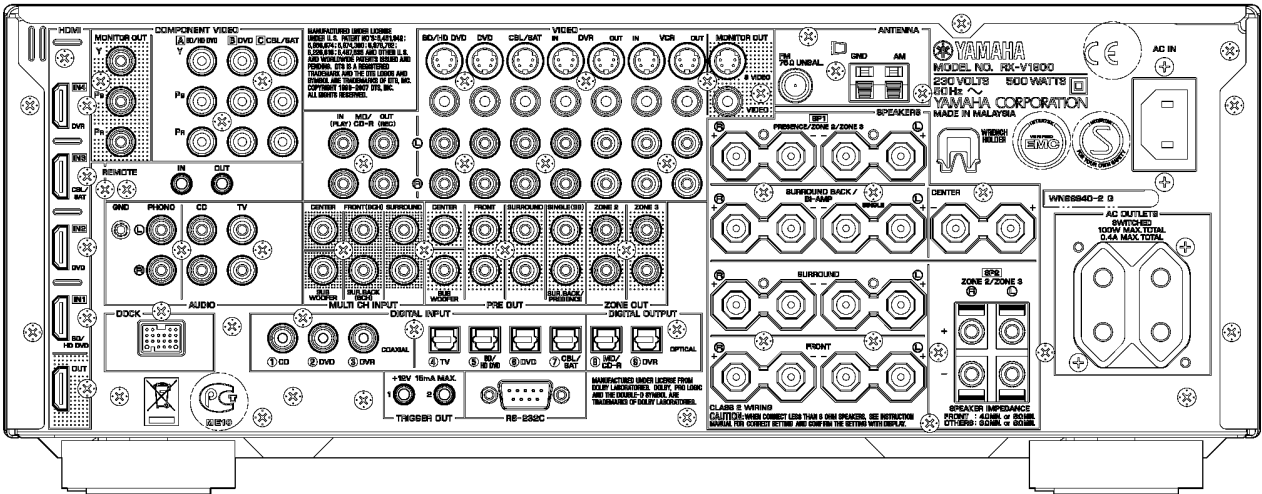

RX-V1900 (L model)

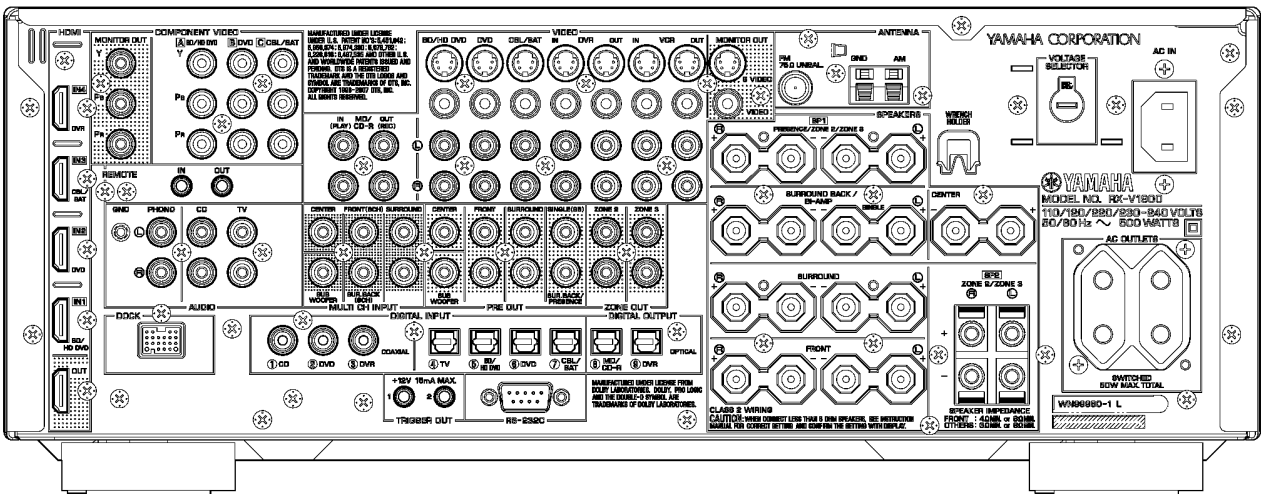

HTR-6290 (C model)

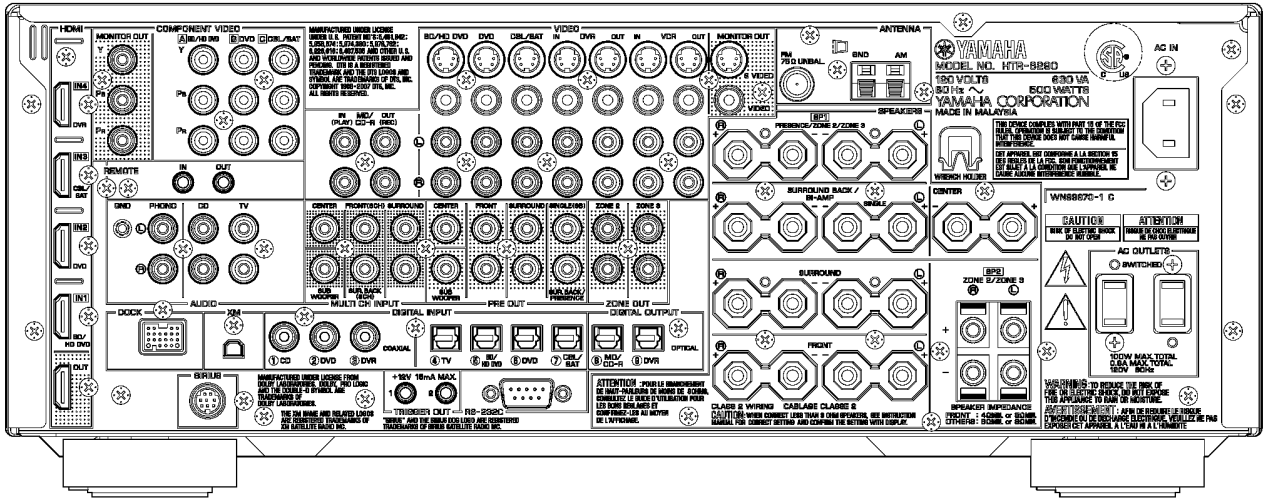

HTR-6290 (G model)

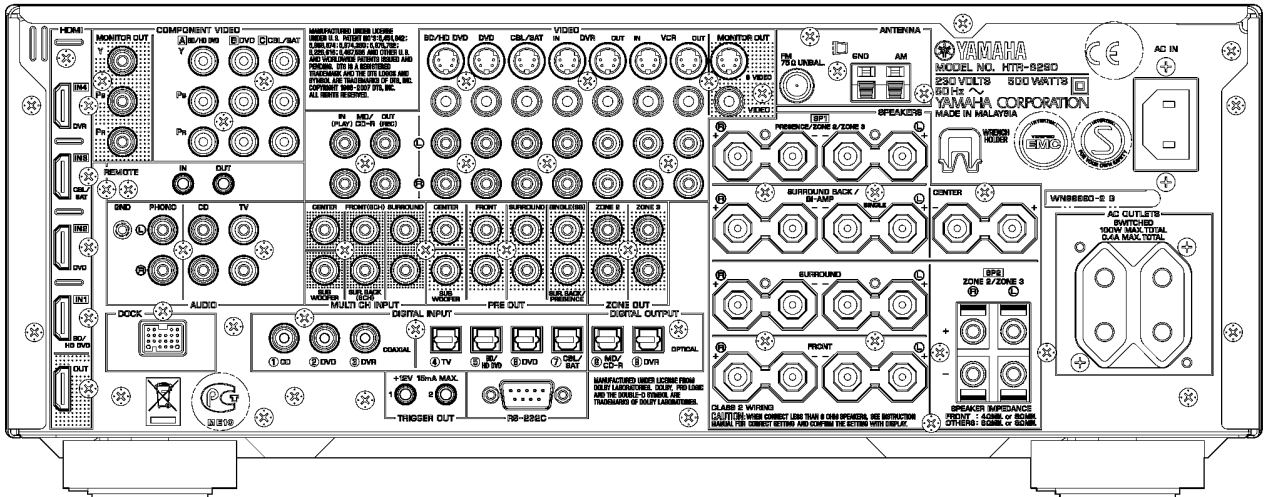

DSP-AX1900 (J model)

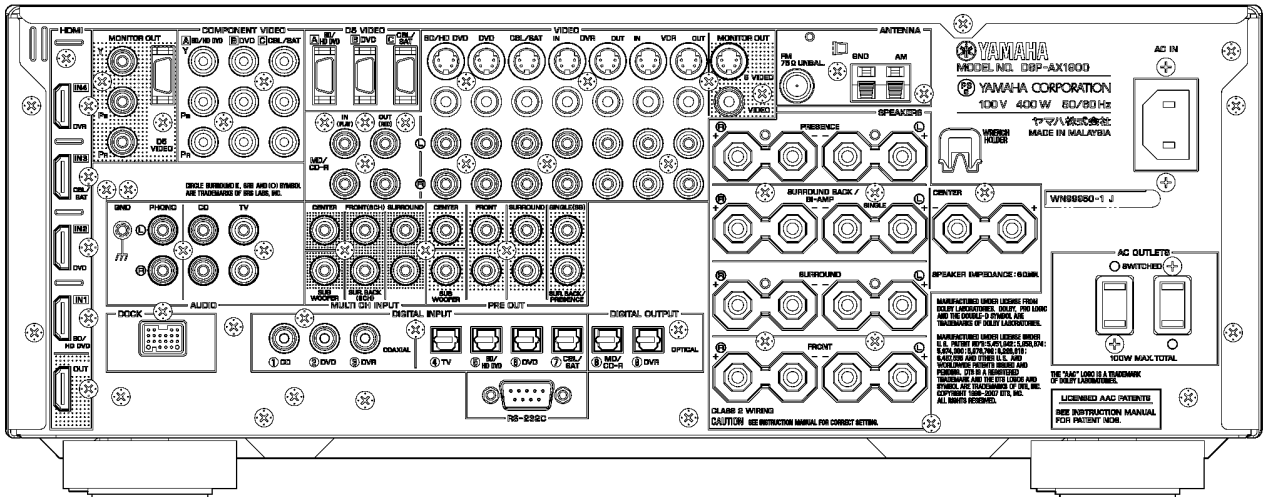

RX-V1900/HTR-6290/
DSP-AX1900

REMOTE CONTROL PANELS

RAV383

RX-V1900 (U, C models)
HTR-6290 (C model)

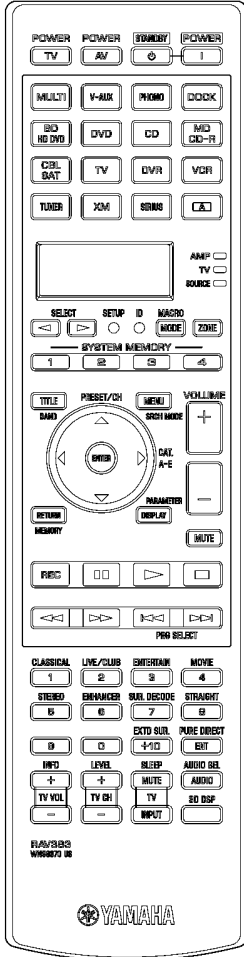

RAV385

RX-V1900 (R, T, K, A, B, G, E, L models)
HTR-6290 (G model)

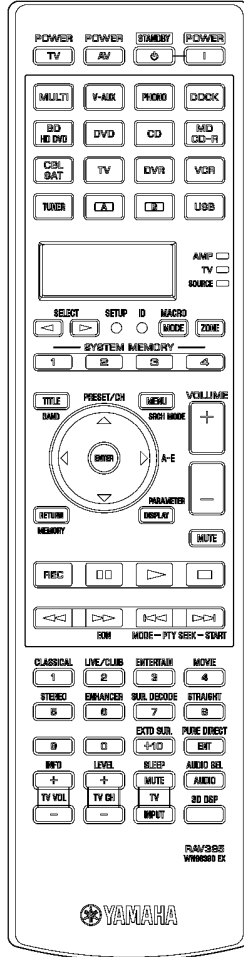

RAV384

DSP-AX1900 (J model)

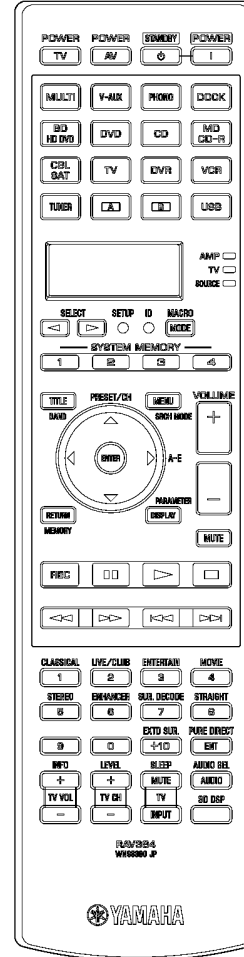

RAV37

RX-V1900 (U, C, R, T, K, A, B, L models)
HTR-6290 (C model)

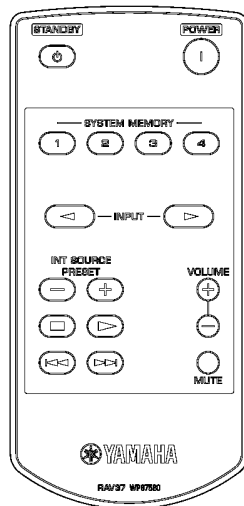

RX-V1900/HTR-6290/
DSP-AX1900

■ SPECIFICATIONS / 参考仕様

■ Audio Section / オーディオ部

Minimum RMS Output Power (Power Amp. Section) / 定格出力 (パワーアンプ部) (20 Hz to 20 kHz)

FRONT L/R	
U, C, R, T, K, A, B, G, E, L models (0.04 % THD, 8 ohms)	130 W + 130 W
J model (0.06 % THD, 6 ohms)	130 W + 130 W
CENTER	
U, C, R, T, K, A, B, G, E, L models (0.04 % THD, 8 ohms)	130 W
J model (0.06 % THD, 6 ohms)	130 W
SURROUND L/R	
U, C, R, T, K, A, B, G, E, L models (0.04 % THD, 8 ohms)	130 W + 130 W
J model (0.06 % THD, 6 ohms)	130 W + 130 W
SURROUND BACK L/R	
U, C, R, T, K, A, B, G, E, L models (0.04 % THD, 8 ohms)	130 W + 130 W
J model (0.06 % THD, 6 ohms)	130 W + 130 W

Maximum Power / 実用最大出力 (JEITA, 1 kHz, 10 % THD)

FRONT L/R	
R, T, K, L models (8 ohms)	175 W + 175 W
J model (6 ohms)	175 W + 175 W
CENTER	
R, T, K, L models (8 ohms)	175 W
J model (6 ohms)	175 W
SURROUND L/R	
R, T, K, L models (8 ohms)	175 W + 175 W
J model (6 ohms)	175 W + 175 W
SURROUND BACK L/R	
R, T, K, L models (8 ohms)	175 W + 175 W
J model (6 ohms)	175 W + 175 W

Dynamic Power Per Channel (IHF)

FRONT L/R (8/6/4/2 ohms)	
U, C, R, T, K, A, L models	160/195/255/335 W

Max. Power Per Channel (1 kHz, 0.7 % THD, 4 ohms)

[B, G, E models]	
FRONT L/R	180 W + 180 W
CENTER	180 W
SURROUND L/R	180 W + 180 W
SURROUND BACK L/R	180 W + 180 W

Dynamic Headroom [U, C, R, T, K, A, L models]

8 ohms	0.9 dB
--------	--------

IEC Power (1 kHz, 0.04 % THD, 8 ohms) [B, G, E models]

FRONT L/R	130 W + 130 W
-----------	---------------

Damping Factor / ダンピングファクタ (1 kHz, 8 ohms)

FRONT L/R	150 or more
-----------	-------------

Input Sensitivity/Input Impedance / 入力感度/入力インピーダンス (1 kHz, 100 W/8 ohms)

PHONO (MM)	3.5 mV / 47 k-ohms
CD, etc.	200 mV / 47 k-ohms
MULTI CH INPUT	
FRONT L/R, CENTER, SURROUND L/R, SUBWOOFER	200 mV / 47 k-ohms

Maximum Input Signal Level / 最大許容入力

PHONO (MM) (1 kHz, 0.1 % THD)	60 mV or more
CD, etc. (1 kHz, 0.5 % THD)	2.4 V or more

Output Level/Output Impedance / 出力電圧/出力インピーダンス

REC OUT (SOURCE OUT)	200 mV / 900 ohms
PRE OUT (FRONT L/R, CENTER, SURROUND L/R, SURROUND BACK L/R)	1.0 V / 1.2 k-ohms
SUBWOOFER (20 Hz)	1.0 V / 1.2 k-ohms
[U, C, R, T, K, A, B, G, E, L models]	
ZONE 2 OUT	1.0 V / 1.4 k-ohms
ZONE 3 OUT	1.0 V / 1.4 k-ohms

Headphone Jack Rated Output/Impedance /

ヘッドフォン出力/出力インピーダンス (1 kHz, 40 mV, 8 ohms)	
CD, etc.	150 mV / 100 ohms

Frequency Response / 周波数特性 (10 Hz to 100 kHz)

CD, etc. to FRONT L/R (Pure direct)	+0/-3 dB
-------------------------------------	----------

RIAA Equalization Deviation / RIAA 偏差 (20 Hz to 20 kHz)

PHONO (MM)	0 ±0.5 dB
------------	-----------

Total Harmonic Distortion / 全高調波歪率 (20 Hz to 20 kHz)

PHONO (MM) to REC OUT (1 V)	0.02 % or less
CD, etc. to FRONT L/R SP OUT (65 W, 8 ohms)	0.04 % or less

Signal to Noise Ratio / 信号対雑音比 (IHF-A network)

PHONO (MM) (Input shorted) to SP OUT	
U, C, R, T, K, L models (5 mV)	86 dB or more
A, B, G, E models (5 mV)	81 dB or more
J model (2.5 mV)	80 dB or more
CD, etc. (Input shorted) to SP OUT	
250 mV	100 dB or more

Residual Noise / 残留ノイズ (IHF-A network)

FRONT L/R SP OUT	150 µV or less
------------------	----------------

Channel Separation / チャンネルセパレーション (1 kHz/10 kHz)

PHONO (Input shorted)	60 dB or more/55 dB or more
CD, etc. (Input 5.1 k-ohms shorted)	60 dB or more/45 dB or more

Tone Control Characteristics / トーンコントロール特性

BASS	
Boost/Cut	±6 dB (50 Hz)
Turnover frequency	350 Hz
TREBLE	
Boost/Cut	±6 dB (20 kHz)
Turnover frequency	3.5 kHz

ZONE2, ZONE3 Tone Control Characteristics

[U, C, R, T, K, A, B, G, E, L models]	
BASS	
Boost/Cut	±10 dB (100 Hz)
Turnover frequency	450 Hz
TREBLE	
Boost/Cut	±10 dB (10 kHz)
Turnover frequency	2.0 kHz

Filter Characteristics / フィルター特性

FRONT, CENTER, SURROUND, SURROUND BACK small (H.P.F.)	
fc=40/60/80/90/100/110/120/160/200 Hz, 12 dB/oct.	
SUBWOOFER (L.P.F.)	
fc=40/60/80/90/100/110/120/160/200 Hz, 24 dB/oct.	

■ Video Section / ビデオ部

Video Signal Type / ビデオ信号方式

Gray back	
U, C, R, K, J models	NTSC
T, A, B, G, E, L models	PAL
Video conversion	NTSC/PAL

Composite Video Signal Level / コンポジットビデオ信号

	1 Vp-p / 75 ohms
--	------------------

S-Video Signal Level / S ビデオ信号

Y	1 Vp-p / 75 ohms
C	0.286 Vp-p / 75 ohms

Component Video Signal Level / コンポーネントビデオ信号

Y	1 Vp-p / 75 ohms
Pb/Pr	0.7 Vp-p / 75 ohms

Maximum Input Level / 最大許容入力

VIDEO CONV. OFF	1.5 Vp-p or more
-----------------	------------------

Signal to Noise Ratio / 信号対雑音比

VIDEO CONV. OFF	60 dB or more
-----------------	---------------

Monitor Out Frequency Response / モニターアウト周波数帯域

(VIDEO CONV. OFF)	
Component video signal	5 Hz to 100 MHz, ±3 dB
[J model]	
D5-video signal	5 Hz to 100 MHz, ±3 dB

■ FM Section / FM 部

Tuning Range / 受信周波数範囲

U, C models	87.5 to 107.9 MHz
R, L models	87.5 to 108.0 / 87.50 to 108.00 MHz
T, K, A, B, G, E models	87.50 to 108.00 MHz
J model	76.0 to 90.0 MHz

50dB Quieting Sensitivity / 50 dB SN 感度 (IHF)

(1 kHz, 100 % MOD.)	
Mono	2.0 μV (17.3 dBf)
Stereo	25 μV (39.2 dBf)

Usable Sensitivity / 実用感度 (IHF)

Mono	1.0 μV (11.2 dBf)
------	-------------------

Selectivity / 選択度

at 400 kHz	70 dB
------------	-------

Signal to Noise Ratio / 信号対雑音比 (IHF)

Mono	76 dB
Stereo	70 dB

Harmonic Distortion / 歪率 (1 kHz)

Mono	0.2 %
Stereo	0.3 %

Stereo Separation / ステレオセパレーション

	42 dB
--	-------

Frequency Response / 周波数特性 (20 Hz to 15 kHz)

	+0.5 / -2 dB
--	--------------

Antenna Input / アンテナ入力

	75 ohms unbalanced
--	--------------------

■ AM Section / AM 部

Tuning Range / 受信周波数範囲

U, C models	530 to 1,710 kHz
R, L models	530 to 1,710 / 531 to 1,611 kHz
T, K, A, B, G, E, J models	531 to 1,611 kHz

Usable Sensitivity / 実用感度

	300 μV/m
--	----------

Antenna Input / アンテナ入力

	Loop Antenna
--	--------------

■ General / 総合

Power Supply / 電源電圧

U, C models	AC 120 V, 60 Hz
R, L models	AC 110/120/220/230-240 V, 50/60 Hz
T model	AC 220 V, 50 Hz
K model	AC 220 V, 60 Hz
A model	AC 240 V, 50 Hz
B, G, E models	AC 230 V, 50 Hz
J model	AC 100 V, 50/60 Hz

Power Consumption / 消費電力

U, C models	500 W / 630 VA
R, T, K, A, B, G, E, L models	500 W
J model	400 W

Standby Power Consumption (reference data) /

待機時消費電力 (参考値)	
Advanced setup – wake on RS232C access: OFF	
U, C, T, K, A, B, G, E, L, J models	0.1 W or less
R model (AC 240 V / 50 Hz)	0.33 W or less

Maximum Power Consumption (6ch drive, 10 % THD) [R model]

	1100 W
--	--------

AC Outlets / AC アウトレット

2 switched outlets	
U, C models	100 W max. total / 0.8 A max. total
R, T, L models	50 W max. total
G, E models	100 W max. total / 0.4 A max. total
J model	100 W max. total
1 switched outlet	
A model	100 W max.
B model	100 W max. / 0.4 A max.

Dimensions (W x H x D) / 寸法 (幅 × 高さ × 奥行き)

	435 x 171 x 438.5 mm (17-1/8" x 6-3/4" x 17-1/4")
--	---

Weight / 質量

	17.1 kg (37 lbs. 11 oz.)
--	--------------------------

Finish / 仕上げ

[RX-V1900]	
Gold color	R, T, K models
Black color	U, C, R, T, K, A, B, G, E, L models
Titanium color	R, G, E, L models
[HTR-6290]	
Black color	C, G models
[DSP-AX1900]	
Gold color	J model

Accessories / 付属品

Remote control x 1, Simplified remote control x 1 (U, C, R, T, K, A, B, L models), Batteries (R03, AAA, UM-4) x 4 / (CR2032) x 1 (U, C, R, T, K, A, B, L models), Indoor FM antenna (1.4 m) x 1, AM loop antenna (1.2 m) x 1 (U model) / (1.0 m) x 1 (C, R, T, K, A, B, G, E, L, J models), Power cable (2 m) x 1 (U, C, R, T, K, A, B, G, E, J models) / x 2 (L model), Optimizer microphone (6 m) x 1, Speaker terminal wrench x 1

* Specifications are subject to change without notice due to product improvements.

※ 参考仕様および外観は予告なく変更されることがあります。

UU.S.A. model	BBritish model
CCanadian model	GEuropean model
RGeneral model	ESouth European model
TChinese model	LSingapore model
KKorean model	JJapanese model
AAustralian model		



Manufactured under license from Dolby Laboratories. Dolby and the double-D symbol are registered trademarks of Dolby Laboratories.

ドルビーラボラトリーズからの実施権に基づき製造されています。「ドルビー」、「PRO LOGIC」、「Surround EX」およびダブルD記号  は、ドルビーラボラトリーズの商標です。



DTS is a registered trademark and the DTS logos, Symbol, DTS-HD and DTS-HD Master Audio are trademark of DTS, Inc.

DTS は DTS 社の登録商標です。また、DTS ロゴ、記号、および DTS-HD、DTS-HD Master Audio は DTS 社の商標です。

iPod™

"iPod" is a trademark of Apple Inc., registered in the U.S. and other countries. iPod は、米国およびその他の国々で登録された Apple Inc. の商標または登録商標です。



"HDMI", the "HDMI" logo and "High-Definition Multimedia Interface" are trademarks, or registered trademarks of HDMI Licensing LLC.

HDMI、HDMI ロゴ、および High-Definition Multimedia Interface は、HDMI Licensing, LLC の商標または登録商標です。

x.v.Color™

"x.v.Color" is a trademark of Sony Corporation.
「x.v.Color」は、ソニー株式会社の商標です。



AAC ロゴマークはドルビーラボラトリーズの商標です。

**SILENT™
CINEMA**

"SILENT CINEMA" is a trademark of Yamaha Corporation.
「サイレントシネマ™ SILENT CINEMATM」はヤマハ株式会社の登録商標です。



The XM name and related logos are registered trademarks of XM Satellite Radio Inc.



This product is manufactured under license from Neural Audio Corporation and THX Ltd. YAMAHA CORPORATION hereby grants the user a non-exclusive, non-transferable, limited right of use to this product under U.S.A. and foreign patent, patent pending and other technology or trademarks owned by Neural Audio Corporation and THX Ltd. "Neural Surround", "Neural Audio", "Neural" and "NRL" are trademarks and logos owned by Neural Audio Corporation. THX is a trademark of THX Ltd., which may be registered in some jurisdictions. All rights reserved.



©2006 SIRIUS Satellite Radio Inc. "SIRIUS", "SiriusConnect", the SIRIUS dog logo, channel names and logos are trademarks of SIRIUS Satellite Radio Inc.



HD Radio™ Technology Manufactured Under License From iBiquity Digital Corp. U.S. and Foreign Patents. HD Radio™ and the HD Radio logo are proprietary trademarks of iBiquity Digital Corp.



Circle Surround II, Dialog Clarity, TruBass, SRS and the (●) symbol are trademarks of SRS Labs, Inc.
Circle Surround II, Dialog Clarity and TruBass technologies are incorporated under license from SRS Labs, Inc.

Circle Surround II, FOCUS, TruBass, SRS と (●) 記号は SRS Labs, Inc. の商標です。Circle Surround II, FOCUS と TruBass 技術は SRS Labs, Inc. からのライセンスに基づき製品化されています。



Fraunhofer Institut Integrierte Schaltungen

MPEG Layer-3 audio coding technology licensed from Fraunhofer IIS and Thomson.

• DIMENSIONS / 寸法図

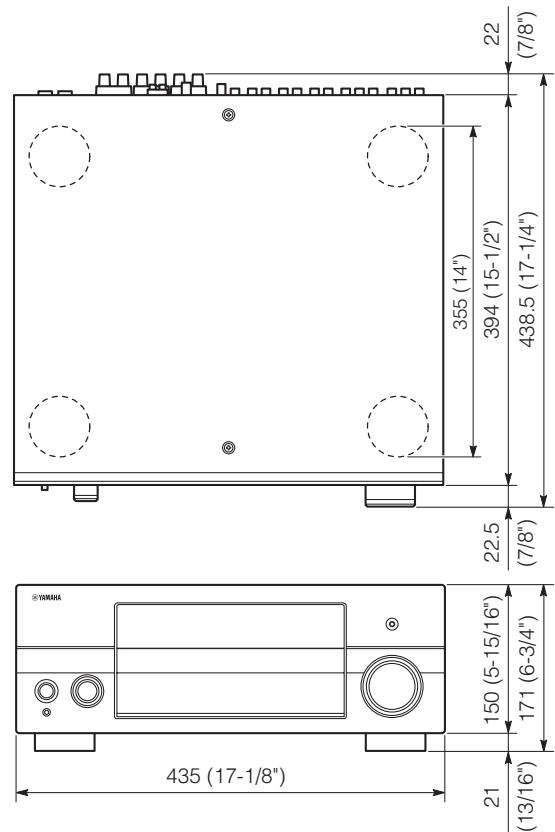

Unit: mm (inch)
単位: mm (インチ)

RX-V1900/HTR-6290/
DSP-AX1900

• SELECT MENU

Category	Sound Field	Parameter																														
		Decode Type	DSP Level: -6dB to +3dB	Init. Delay: 1 to 99ms	Room Size: 0.1 to 2.0	Liveness: 0 to 10	Sur. Init. Delay: 1 to 49ms	Sur. Room Size: 0.1 to 2.0	Sur. Liveness: 0 to 10	SB. Init. Delay: 1 to 49ms	SB. Room Size: 0.1 to 2.0	SB. Liveness: 0 to 10	Rev. Time: 1.0 to 5.0s	Rev. Delay: 0 to 250ms	Rev. Level: 0 to 100%	Dialogue Lift: 0 to 5	Center Level: 0 to 100%	Surround L Level: 0 to 100%	Surround R Level: 0 to 100%	Sur.Back Level: 0 to 100%	Presence L Level: 0 to 100%	Presence R Level: 0 to 100%	Direct: Auto/Off	Effect Level: High/Low	Panorama: On/Off	Center Width: 0 to 7	Dimension: -3 to +3	Center Image: 0.0 to 1.0	FOCUS: 0 to 8	TruBass: 0 to 8	Initialize	
CLASSICAL	Hall in Munich	●	●	●	●											●																●
	Hall in Vienna	●	●	●	●											●																●
	Hall in Amsterdam	●	●	●	●											●																●
	Church in Freiburg	●	●	●	●											●	●	●	●													●
	Chamber	●	●	●	●											●	●	●	●													●
LIVE/CLUB	Village Vanguard	●	●	●	●											●															●	
	Warehouse Loft	●	●	●	●											●	●	●	●													●
	Cellar Club	●	●	●	●											●																●
	The Roxy Theatre	●	●	●	●											●	●	●	●													●
	The Bottom Line	●	●	●	●											●																●
ENTERTAINMENT	Sports	●	●	●	●			●	●		●	●				●															●	
	Action Game	●	●	●	●			●	●		●	●				●															●	
	Roleplaying Game	●	●	●	●			●	●		●	●				●															●	
	Music Video	●	●	●	●			●	●		●	●				●															●	
	Recital/Opera	●	●	●	●			●	●		●	●				●															●	
MOVIE	Standard	●*1	●	●	●			●	●	●	●	●	●	●	●	●															●	
	Spectacle	●*1	●	●	●			●	●	●	●	●	●	●	●	●															●	
	Sci-Fi	●*1	●	●	●			●	●	●	●	●	●	●	●	●															●	
	Adventure	●*1	●	●	●			●	●	●	●	●	●	●	●	●															●	
	Drama	●*1	●	●	●			●	●	●	●	●	●	●	●	●															●	
	Mono Movie	●	●	●	●	●										●	●	●	●													●
STEREO	2ch Stereo																														●	
	7ch Stereo																●	●	●	○	●	●									●	
MUSIC ENHANCER	Straight Enhancer																								●						●	
	7ch Enhancer																							●							●	
SUR. DECODE	Surround Decoder	●*2																													●	
STRAIGHT																										△	△	△	▲	■	■	●

△ : Setting is possible only when Pro Logic II x Music (Pro Logic II Music) is selected using decode type. / Decode Type で Pro Logic II x Music (Pro Logic II Music) を選択時のみ設定可

▲ : Setting is possible only when Neo:6 Music is selected using decode type. / Decode Type で Neo:6 Music を選択時のみ設定可

■ : Setting is possible only when CS II Cinema/Music is selected using decode type. / Decode Type で CS II Cinema/Music を選択時のみ選択可

*1 Decode Type

Decode Type	PL II x Movie	PL II when Surround Back is None. / Surround Back が None の場合は PL II
	Neo:6 Cinema	

*2 Decode Type

Decode Type	Pro Logic	(U, J models) (U, C modes) (U, C modes)
	PL II x Movie	
	PL II x Music	
	PL II x Game	
	Neo:6 Cinema	
	Neo:6 Music	
	CS II Cinema	
	CS II Music	
	Neural-THX	
Neural-THX Digital Music		

• SET MENU TABLE / セットメニュー
MANUAL SETUP

MAIN MENU	SUB MENU	PARAMETER	VALUE [INITIAL VALUE]	
1 SPEAKER MENU	A) CONFIG	LFE/BASS OUT	SWFR / FRONT / [BOTH]	
		FRONT SP	SMALL / [LARGE]	
		CENTER SP		
		SUR. L/R SP	NONE / [SMALL] / LARGE	
		SUR. B L/R SP	NONE / SMLx1 / [SMLx2] / LRGx1 / LRGx2	
		PRESENCE SP	NONE / [YES]	
		CROSS OVER FREQ	40 / 60 / [80] / 90 / 100 / 110 / 120 / 160 / 200 Hz	
		SUBWOOFER PHASE	[NORMAL] / REVERSE	
	B) LEVEL	FR. L	-10.0 to +10.0 dB, [0 dB], 0.5 dB step
		FR. R	
		CENT.	
		SUR. L	-10.0 to +10.0 dB, [-1.0 dB], 0.5 dB step
		SUR. R	
		SB L	
		SB R	
		SWFR	
		PR. L	-10.0 to +10.0 dB, [0 dB], 0.5 dB step
		PR. R	
	C) DISTANCE	UNIT		meters (m) / feet (ft)
		FRONT L		0.30 to 24.00 m, [3.00 m], 0.10 m step / 1.0 to 80.0 ft, [10.0 ft], 0.5 ft step
		FRONT R		
		CENTER		
		SUR. L		0.30 to 24.00 m, [2.60 m], 0.10 m step / 1.0 to 80.0 ft, [8.5 ft], 0.5 ft step
		SUR. R		
		SB L		
		SB R		
		SWFR		
PRNS L			0.30 to 24.00 m, [3.00 m], 0.10 m step / 1.0 to 80.0 ft, [10.0 ft], 0.5 ft step	
PRNS R				
D) TEST TONE			[OFF] / ON	
2 VOLUME MENU		ADAPTIVE DRC		AUTO / [OFF]
	ADAPTIVE DSP LEVEL			
	MUTING TYPE		[FULL] / -20 dB	
	MAX VOL.		[+16.5 dB] / +15.0 dB / +10.0 dB / +5.0 dB / 0.0 dB / -5.0 dB / -10.0 dB / -15.0 dB / -20.0 dB / -25.0 dB / -30.0 dB	
	INIT. VOL.		[OFF] / MUTE / -80.0 to +16.5 dB, 0.5 dB step	
3 SOUND MENU	A) EQUALIZER	EQ TYPE	AUTO PEQ / [GEQ] / OFF	
		GEQ EDIT	* "GEQ EDIT" is available only when "EQ TYPE" is set to "GEQ". / "GEQ" 選択時のみ設定可能	
		TEST	[OFF] / ON	
		CHANNEL		
		FRONT L		-6.0 to +6.0 dB, [0 dB], 0.5 dB step
		FRONT R		
		CENTER	63 Hz	
		SUR. L	160 Hz	
		SUR. R	400 Hz	
		SB L	1 kHz	
		SB R	2.5 kHz	
		PRNS L	6.3 kHz	
		PRNS R	16 kHz	
	SWFR	63 Hz		
	PEQ SELECT	160 Hz	[NATURAL] / FLAT / FRONT * "PEQ SELECT" is available only when "EQ TYPE" is set to "AUTO PEQ". / "AUTO PEQ" 設定時のみ選択可能	
	B) LFE LEVEL	SPEAKER HEADPHONE		-20 to 0 dB, [0 dB], 1 dB step
	C) DYNAMIC RANGE	SPEAKER HEADPHONE		MIN/AUTO / STD / [MAX]
	D) LIPSYNC	HDMI AUTO		OFF / [ON]
		AUTO DELAY		
		MANUAL DELAY		0 to 240 ms, [0 ms], 1 ms step
	E) AUDIO SET	TONE BYPASS		[AUTO] / OFF
		HDMI AUDIO		[AMP] / AMP+TV
DUAL MONO (J model)			[MAIN] / SUB / ALL	
F) PURE DIRECT	MODE		[AUDIO] / AUDIO+VIDEO	

RX-V1900/HTR-6290/DSP-AX1900

MAIN MENU	SUB MENU	PARAMETER	VALUE [INITIAL VALUE]	
4 VIDEO MENU	VIDEO CONV.		[ON] / OFF	
	COMPONENT I/P		ON / [OFF]	
	HDMI RES.		NTSC: [*THROUGH] / *480p / *720p / *1080i / *1080p PAL: [*THROUGH] / *576p / *720p / *1080i / *1080p	
	HDMI ASPECT		[THRGH] / 16:9 (Normal) / SMART (smart zoom)	
5 INPUT MENU	A) SIRIUS (U, C models)	[2], [3], [5]	{1} I/O ASSIGNMENT	
	B) XM (U, C models)	[2], [3], [5]		
	C) TUNER	[2], [3], [5]		
	D) MULTI CH	[2], [3], [5], [8]	{2} INPUT RENAME	
	E) PHONO	[1], [2], [3], [4], [5]		
	F) CD	[1], [2], [3], [4], [5]		
	G) TV	[1], [2], [3], [4], [5]		
	H) MD/CD-R	[1], [2], [3], [4], [5]		
	I) BD/HD DVD	[1], [2], [3], [4]		
	J) DVD	[1], [2], [3], [4]		
	K) CBL/STA	[1], [2], [3], [4]	{3} VOL. TRIM	
	L) DVR	[1], [2], [3], [4]	{4} DECODER MODE	
	M) VCR	[1], [2], [3], [4]	{5} BGV	
	N) V-AUX	[1], [2], [3], [4]	{6} STANDBY CHARGE	
O) DOCK	[2], [3], [6]	{7} START PAIRING		
P) BLUETOOTH	[2], [3], [5], [7]	{8} INPUT CH		
Q) USB (R, T, K, A, B, G, E, L, J models)	[2], [3], [5]	FRONT		
6 OPTION MENU	A) DISPLAY SET	DIMMER	-4 to 0, [0], 1 step	
		OSD SHIFT	-5 to +5, [0], 1 step	
		GRAY BACK	[AUTO] / OFF	
		SHORT MESSAGE	[ON] / OFF	
		ON SCREEN	ALWAYS / 10S / [30S]	
		FL SCROLL	[CONT] / ONCE	
	B) MEMORY GUARD		[OFF] / ON	
	C) INIT. CONFIG	AUDIO SELECT		
		DECODER MODE	[AUTO] / LAST	
		EXTD SUR.		
	D) ZONE SET (U, C, R, T, K, A, B, G, E, L models)			ZONE2 / ZONE3
		AMP		EXT (Bi-AMP ON) / [SP1] (SURROUND) / [SP2] (SURROUND BACK) / BOTH (SP1/SP2)
		VOLUME		[VAR] / FIX
		MAX VOL.		[+16.5 dB] / +15.0 dB / +10.0 dB / +5.0 dB / 0.0 dB / -5.0 dB / -10.0 dB / -15.0 dB / -20.0 dB / -25.0 dB / -30.0 dB
		INIT. VOL.		[OFF] / MUTE / -80.0 to +16.5 dB, 0.5 dB step

■ INTERNAL VIEW

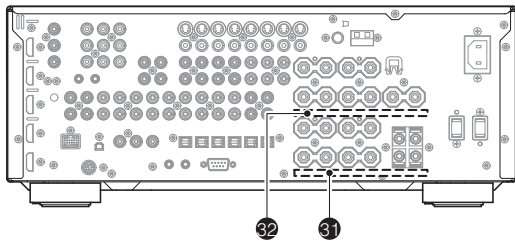
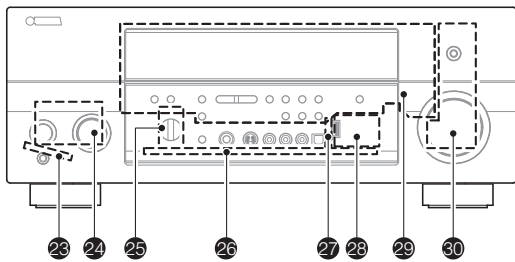
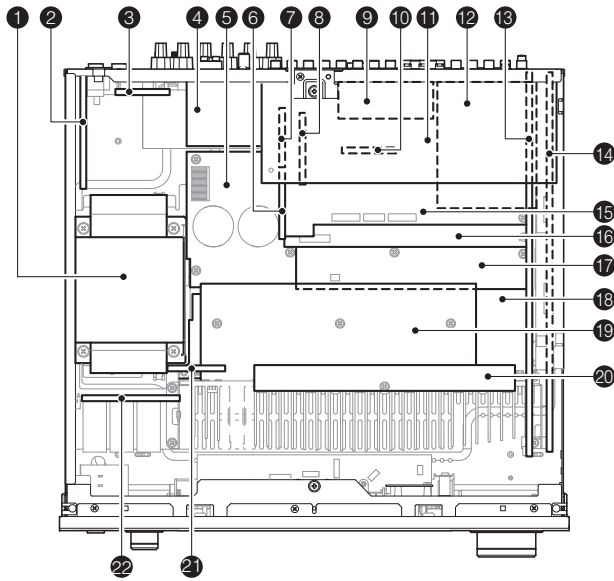

- ① Power Transformer
- ② POWER (4) P.C.B.
- ③ POWER (2) P.C.B. (R, L models)
- ④ HD Radio Tuner (U model)
- ⑤ AM/FM Tuner (C, R, T, K, A, B, G, E, L, J models)
- ⑥ MAIN (2) P.C.B.
- ⑦ FL (3) P.C.B.
- ⑧ FL (5) P.C.B.
- ⑨ CONNECT (1) P.C.B. (U model)
- ⑩ FL (6) P.C.B.
- ⑪ FL (4) P.C.B.
- ⑫ A-VIDEO P.C.B.
- ⑬ CONNECT (2) P.C.B. (U, C models)
- ⑭ NET P.C.B. (R, T, K, A, B, G, E, L, J models)
- ⑮ FL (2) P.C.B.
- ⑯ D-VIDEO P.C.B.
- ⑰ FUNCTION (1) P.C.B.
- ⑱ FUNCTION (2) P.C.B.
- ⑲ DSP P.C.B.
- ⑳ MAIN (1) P.C.B.
- ㉑ POWER (3) P.C.B.
- ㉒ POWER (5) P.C.B.
- ㉓ POWER (6) P.C.B.
- ㉔ POWER (1) P.C.B.
- ㉕ OPERATION (5) P.C.B.
- ㉖ OPERATION (1) P.C.B.
- ㉗ OPERATION (4) P.C.B.
- ㉘ OPERATION (3) P.C.B.
- ㉙ OPERATION (6) P.C.B. (R, T, K, A, B, G, E, L, J models)
- ㉚ OPERATION (7) P.C.B. (R, T, K, A, B, G, E, L, J models)
- ㉛ FL (1) P.C.B.
- ㉜ OPERATION (2) P.C.B.
- ㉝ MAIN (3) P.C.B.
- ㉞ MAIN (4) P.C.B.

RX-V1900/HTR-6290/
DSP-AX1900

DISASSEMBLY PROCEDURES / 分解手順

(Remove parts in the order as numbered.)

Disconnect the power cable from the AC outlet.

(番号順に部品を取り外してください。)

AC 電源コンセントから、電源コードを抜いてください。

1. Removal of Top Cover

- a. Remove 2 screws (①), 4 screws (②) and 5 screws (③). (Fig. 1)
- b. Slide the top cover rearward to remove it. (Fig. 1)

1. トップカバーの外し方

- a. ①のネジ 2 本、②のネジ 4 本、③のネジ 5 本を外します。(Fig. 1)
- b. トップカバーを後方へスライドさせ、取り外します。(Fig. 1)

2. Removal of Front Panel

Remove 6 screws (④) and then remove the front panel forward. (Fig. 1)

2. フロントパネルの外し方

④のネジ 6 本を外し、フロントパネルを前方に外します。(Fig. 1)

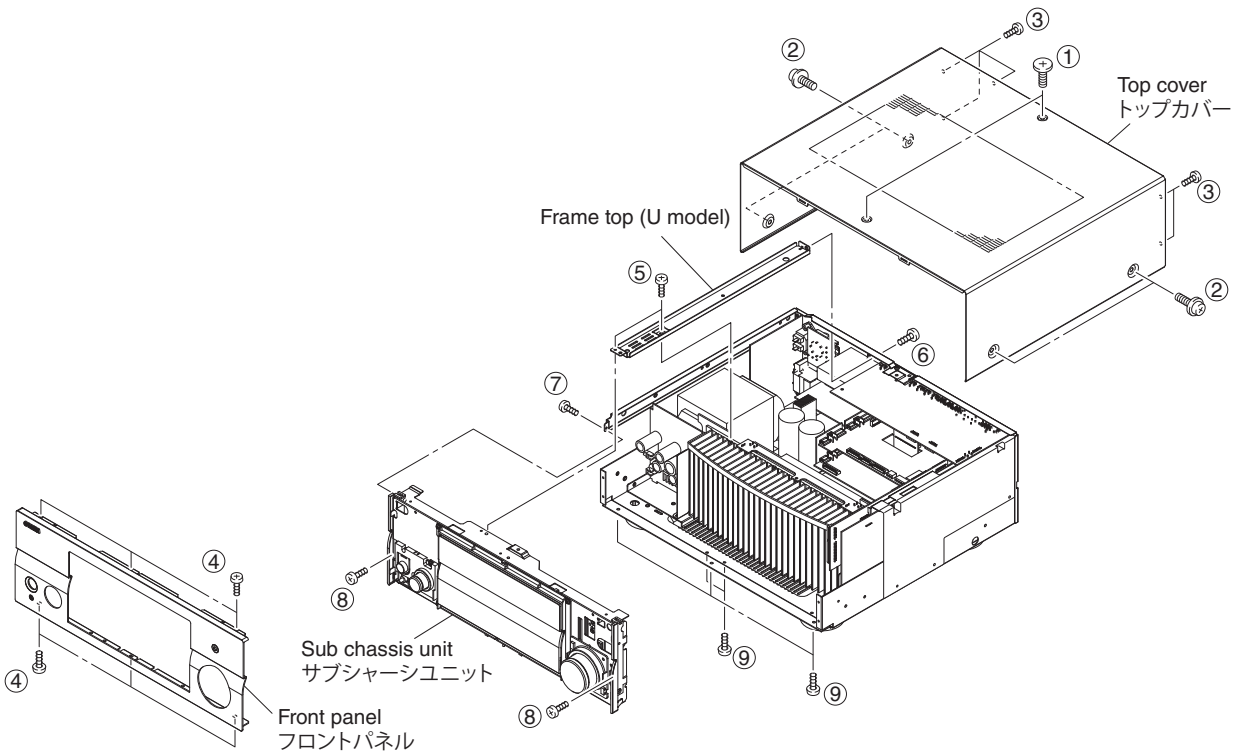

Fig. 1

3. Removal of Sub Chassis Unit

- a. Remove 2 screws (⑤), screw (⑥) and then remove the frame top. (Fig. 1) (U model)
- b. Remove screw (⑦), 2 screws (⑧) and 5 screws (⑨). (Fig. 1)
- c. Remove CB12, CB805-807, CB814 (R, T, K, A, B, G, E, L models), CB970 and CB971. (Fig. 2)
- d. Remove the sub chassis unit forward. (Fig. 1)

3. サブシャーシユニットの外し方

- a. ⑦のネジ 1 本、⑧のネジ 2 本、⑨のネジ 5 本を外します。(Fig. 1)
- b. CB12、CB805-CB807、CB814、CB970、CB971 を外します。(Fig. 2)
- c. サブシャーシユニットを前方に取り外します。(Fig. 1)

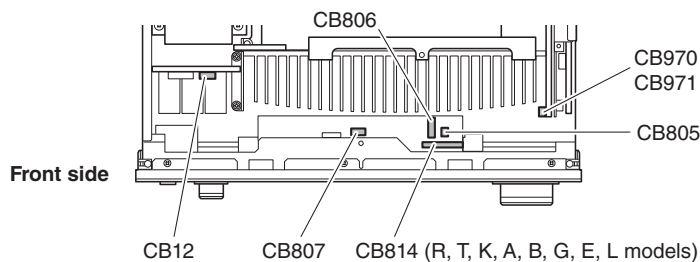

Fig. 2

When checking the P.C.B.s:

- Spread the rubber sheet and the cloth. Then place the sub chassis unit on the cloth and check it. (Fig. 3)
- Reconnect all cables (connectors) that have been disconnected. Be sure to use the extension cable for servicing for the following section.
 - FL (1) P.C.B. CB901—FL (2) P.C.B. CB970: MF126500 (26P, 500mm)
 - FL (2) P.C.B. CB971—OPERATION (2) P.C.B. CB803: MF115500 (15P, 500mm)
 - FL (1) P.C.B. W9001—POWER (1) P.C.B. CB12: MF405400 (5P, 400mm)
- When connecting the flexible flat cable, be careful with polarity.
- Connect the ground point of the sub chassis unit to the chassis with a ground lead or the like. (Fig. 3)

P.C.B. をチェックする場合には：

- ゴムシートと布を敷き、その上にサブシャーシユニットを置いてチェックします。(Fig. 3)
- 外したケーブル (コネクタ) をすべて接続します。ただし次の区間は、サービス用延長ケーブルを使用してください。
 - FL (1) P.C.B. CB901 — FL (2) P.C.B. CB970 : MF126500 (26P、500mm)
 - FL (2) P.C.B. CB971 — OPERATION (2) P.C.B. CB803 : MF115500 (15P、500mm)
 - FL (1) P.C.B. W9001 — POWER (1) P.C.B. CB12 : MF405400 (5P、400mm)
- フラットケーブルを接続する際、極性に注意してください。
- サブシャーシユニットのアースをアース線等でシャーシに接続してください。(Fig. 3)

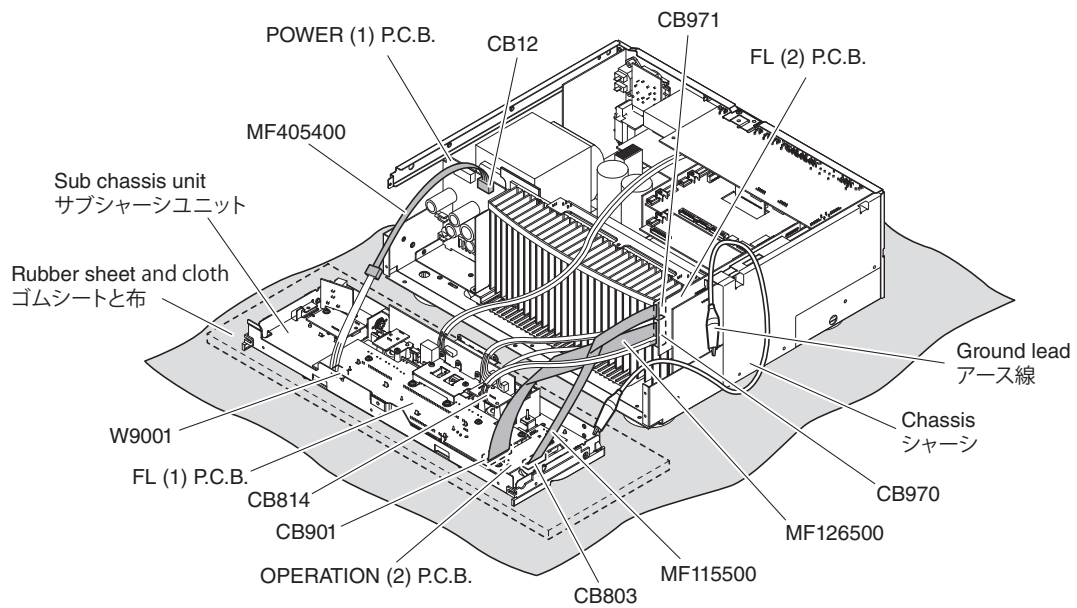

Fig. 3

4. Removal of D-VIDEO P.C.B.

- Remove 2 screws (⑩) and screw (⑪). (U, C, T, K, B, G, E models) (Fig. 4)
- Remove the shield case cover. (U, C, T, K, B, G, E models) (Fig. 4)
- Remove 3 screws (⑫). (Fig. 4)
- Remove screw (⑬). (R, A, L models) (Fig. 4)
- Remove 6 screws (⑭). (Fig. 6)
- Remove CB188, CB204, CB953 and CB957. (Fig. 5)
- Remove CB121, CB122 and then remove the D-VIDEO P.C.B. which is connected directly to the A-VIDEO P.C.B. with board-to-board connectors. (Fig. 4)

5. Removal of A-VIDEO P.C.B.

- Remove 6 screws (⑮). (Fig. 6)
- Remove CB23, CB203. (Fig. 5)
- Remove the A-VIDEO P.C.B.. (Fig. 4)

4. D-VIDEO P.C.B. の外し方

- ⑩のネジ 2 本、⑪のネジ 1 本を外します。(Fig. 4)
- シールドケースカバーを取り外します。(Fig. 4)
- ⑫のネジ 3 本を外します。(Fig. 4)
- ⑭のネジ 6 本を外します。(Fig. 6)
- CB188、CB204、CB953、CB957 を外します。(Fig. 5)
- CB121、CB122 を外し、D-VIDEO P.C.B. を取り外します。ただし、D-VIDEO P.C.B. は、A-VIDEO P.C.B. に基板対基板コネクタで直接接続されています。(Fig. 4)

5. A-VIDEO P.C.B. の外し方

- ⑮のネジ 10 本を外します。(Fig. 6)
- CB23、CB203 を外します。(Fig. 5)
- A-VIDEO P.C.B. を取り外します。(Fig. 4)

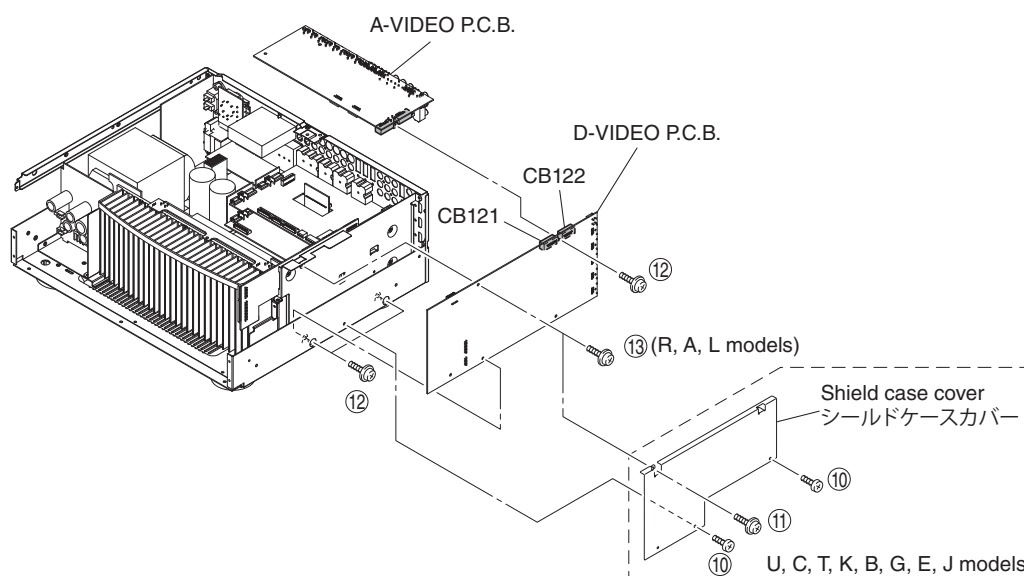

Fig. 4

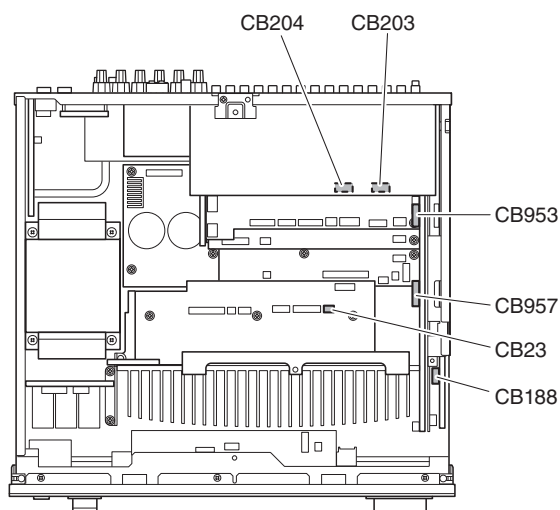
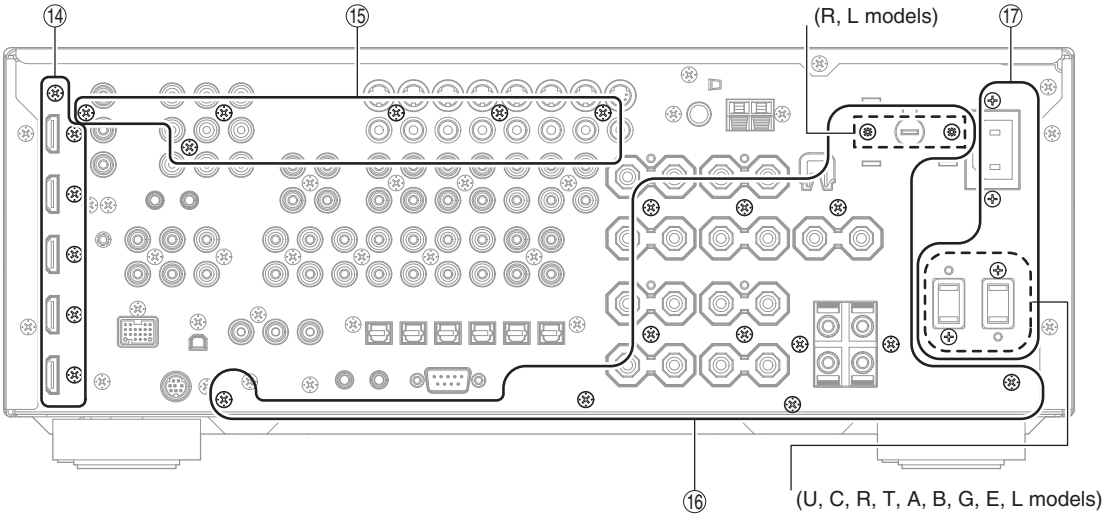

Fig. 5

U, C, R, T, K, A, B, G, E, L models



J model

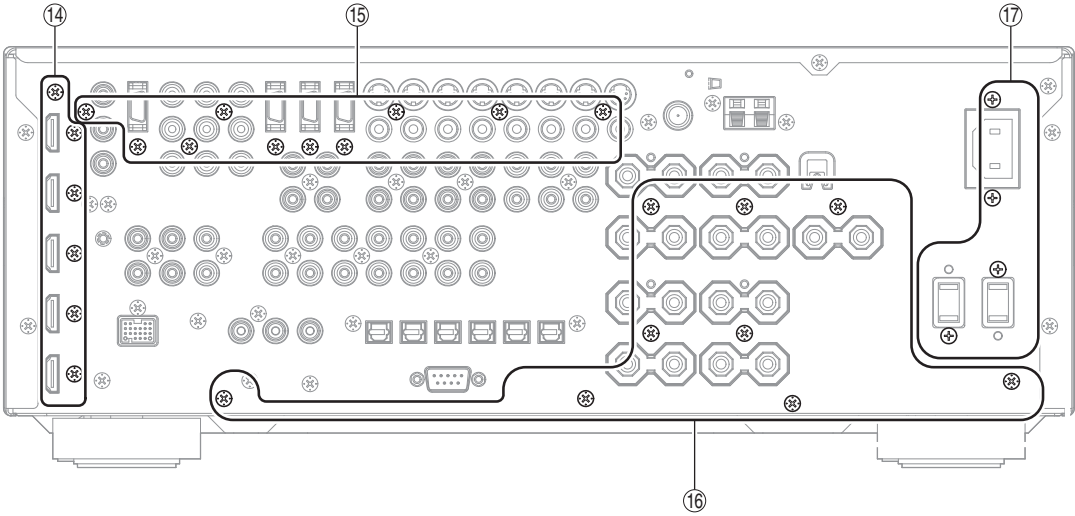

Fig. 6

RX-V1900/HTR-6290/
DSP-AX1900

When checking the P.C.B.s:

- Put the rubber sheet and the cloth over this unit. Then place the D-VIDEO and A-VIDEO P.C.B.s upside down on the cloth and check them. (Fig. 7)
- Reconnect all cables (connectors) that have been disconnected. Be sure to use the extension cable for servicing for the following section.
 FL (2) P.C.B. CB953-D-VIDEO P.C.B. CB102: MFA20250 (20P, 250mm)
 FUNCTION (1) P.C.B. CB410-A-VIDEO P.C.B. CB203: MF111350 (11P, 350mm)
 FL (2) P.C.B. CB957-D-VIDEO P.C.B. CB186: MFA18350 (18P, 350mm)
- When connecting the flexible flat cable, be careful with polarity.
- Connect the ground point of each P.C.B. shown below to the chassis with a ground lead or the like. (Fig. 7)
 D-VIDEO P.C.B. ST101 (Ground)
 D-VIDEO P.C.B. CB103 (HDMI IN1)
 A-VIDEO P.C.B. PJ204 (COMPONENT VIDEO)

P.C.B. をチェックする場合には：

- 本機の上にゴムシートと布を敷き、その上に D-VIDEO および A-VIDEO P.C.B. を裏返しに置いてチェックします。(Fig. 7)
- 外したケーブル (コネクタ) をすべて接続します。ただし次の区間は、サービス用延長ケーブルを使用してください。
 FL (2) P.C.B. CB953 - D-VIDEO P.C.B. CB102 : MFA20250 (20P, 250mm)
 FUNCTION (1) P.C.B. CB410 - A-VIDEO P.C.B. CB203 : MF111350 (11P, 350mm)
 FL (2) P.C.B. CB957 - D-VIDEO P.C.B. CB186 : MFA18350 (18P, 350mm)
- フラットケーブルを接続する際、極性に注意してください。
- 下記に示す各 P.C.B. のアースをアース線などでシャーシに接続してください。(Fig. 7)
 D-VIDEO P.C.B. ST101 (Ground)
 D-VIDEO P.C.B. CB103 (HDMI IN1)
 A-VIDEO P.C.B. PJ204 (COMPONENT VIDEO)

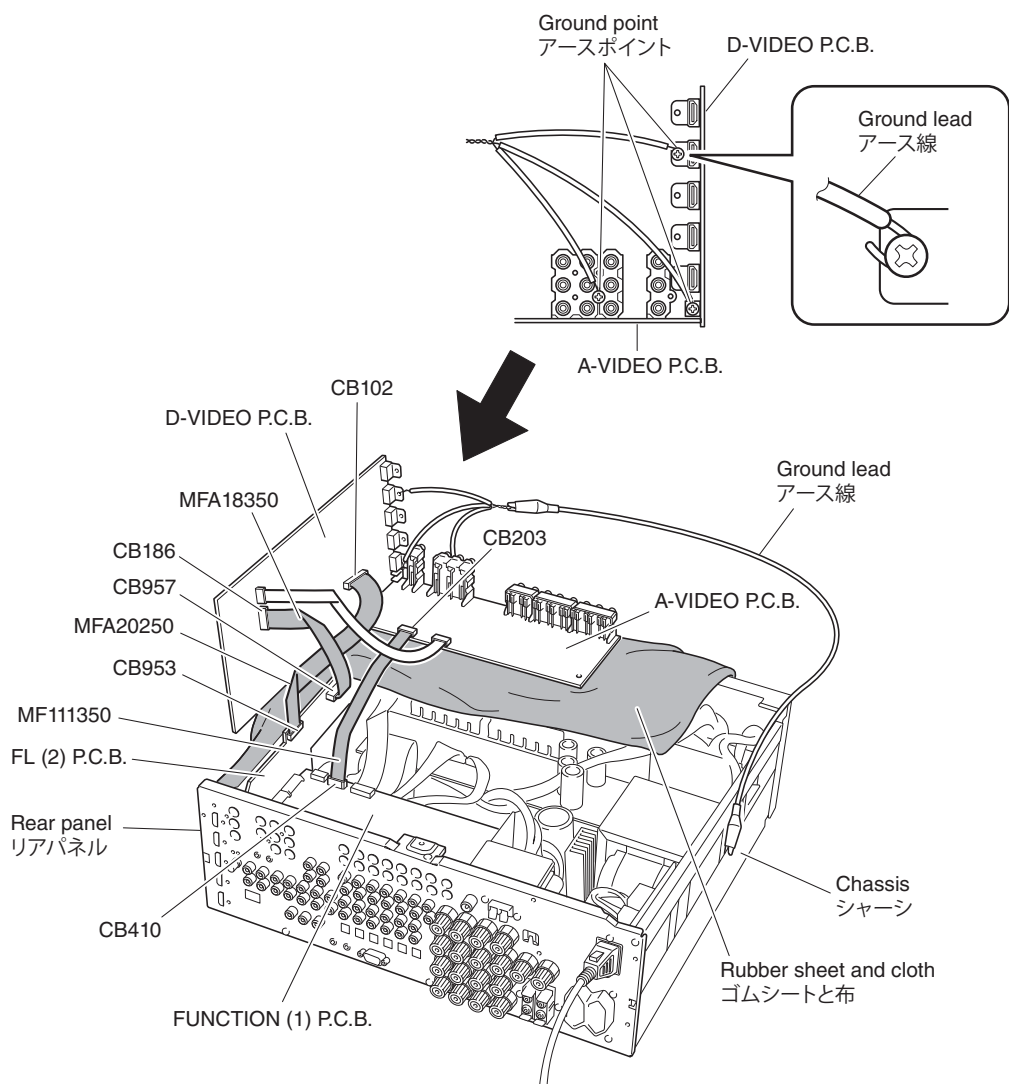

Fig. 7

6. Removal of Rear Unit

- a. Remove 11 (U, C, T, K, A, B, G, E models) / 13 (R, L models) screws (16) and 4 (U, C, R, T, A, B, G, E, L models) / 2 (K model) screws (17). (Fig. 6)
- b. Remove 4 screws (18) and screw (19). (Fig. 8)
- c. Remove screw (20). (R, K, A, L models) (Fig. 8)
- d. Remove CB16-18, CB20, CB21, CB303, CB405, CB406 and CB407. (Fig. 8)
- e. Remove the rear unit and MAIN (2) P.C.B.. (Fig. 8)

6. リアユニットの外し方

- a. ⑯のネジ 9 本、⑰のネジ 4 本を外します。(Fig. 6)
- b. ⑱のネジ 4 本、⑲のネジ 1 本を外します。(Fig. 8)
- c. CB16-18、CB20、CB21、CB303、CB405-407 を外します。(Fig. 8)
- d. リアユニットおよび MAIN (2) P.C.B. を取り外します。

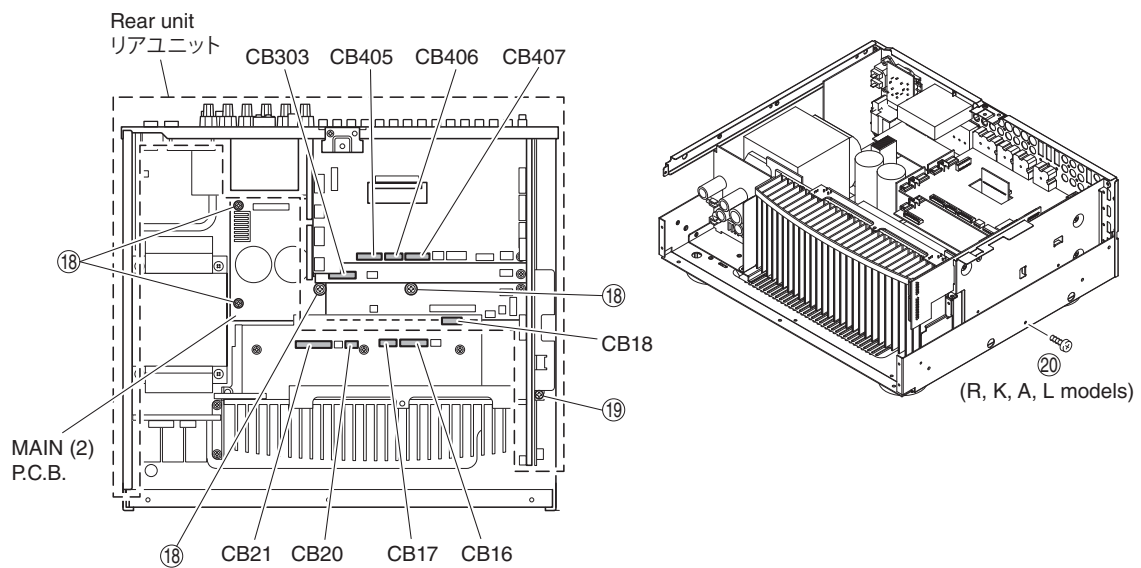

Fig. 8

When checking the P.C.B.s:

- Put the rubber sheet and the cloth over this unit. Then place the rear unit upside down on the cloth and check it. (Fig. 9)
- Reconnect all cables (connectors) that have been disconnected. Be sure to use the extension cable for servicing for the following section.
 FL (1) P.C.B. CB901—FL (2) P.C.B. CB970:
 MF126500 (26P, 500mm)
 FL (2) P.C.B. CB971—OPERATION (2) P.C.B. CB803:
 MF115500 (15P, 500mm)
 FUNCTION (1) P.C.B. CB409—POWER (3) P.C.B. CB18:
 MF114400 (14P, 400mm)
 FUNCTION (1) P.C.B. CB406—POWER (4) P.C.B. W1:
 MF408250 (8P, 250mm)
- When connecting the flexible flat cable, be careful with polarity.
- Connect the ground point of the rear unit to the chassis with a ground lead or the like. (Fig. 9)

P.C.B. をチェックする場合には：

- 本機の上にゴムシートと布を敷き、その上にリアユニットを裏返しに置いてチェックします。(Fig. 9)
- 外したケーブル(コネクタ)をすべて接続します。ただし次の区間は、サービス用延長ケーブルを使用してください。
 FL (1) P.C.B. CB901 — FL (2) P.C.B. CB970 :
 MF126500 (26P、500mm)
 FL (2) P.C.B. CB971 — OPERATION (2) P.C.B. CB803 :
 MF115500 (15P、500mm)
 FUNCTION (1) P.C.B. CB409 — POWER (3) P.C.B. CB18 :
 MF114400 (14P、400mm)
 FUNCTION (1) P.C.B. CB406 — POWER (4) P.C.B. W1 :
 MF408250 (8P、250mm)
- フラットケーブルを接続する際、極性に注意してください。
- リアユニットのアースをアース線等でシャーシに接続してください。(Fig. 9)

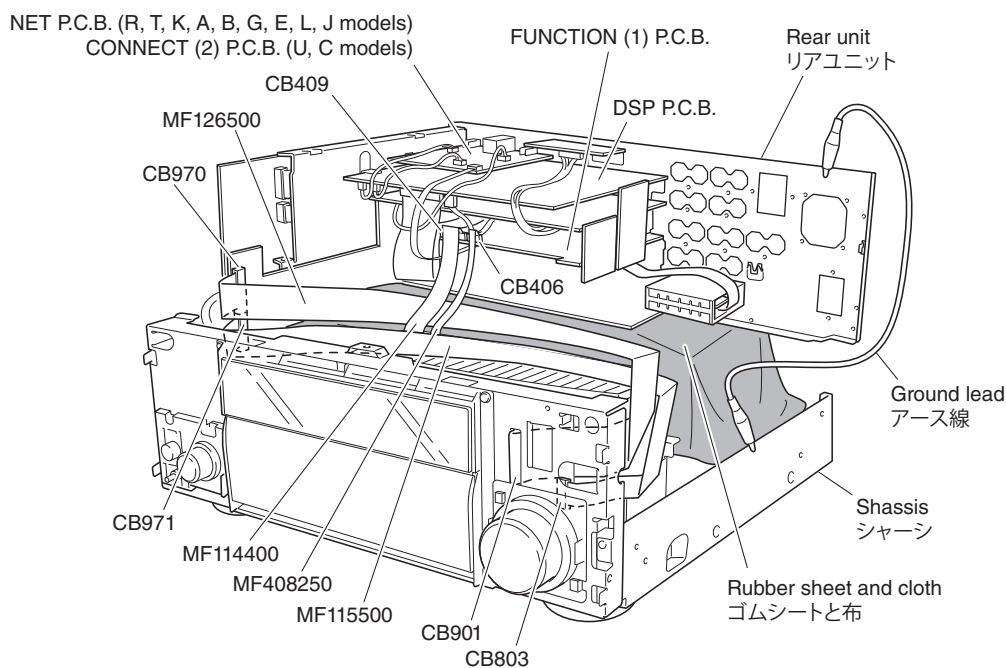

Fig. 9

7. Removal of Amp Unit

- a. Remove 2 screws (21), 5 screws (22) and 2 screws (23). (Fig. 10)
- b. Remove CB6, CB11, CB15 and CB253. (Fig. 10)
- c. Remove the amp unit. (Fig. 10)

7. アンプユニットの外し方

- a. ②①のネジ 2 本、②②のネジ 5 本、②③のネジ 2 本を外します。(Fig. 10)
- b. CB6、CB11、CB15、CB253 を外します。(Fig. 10)
- c. アンプユニットを取り外します。(Fig. 10)

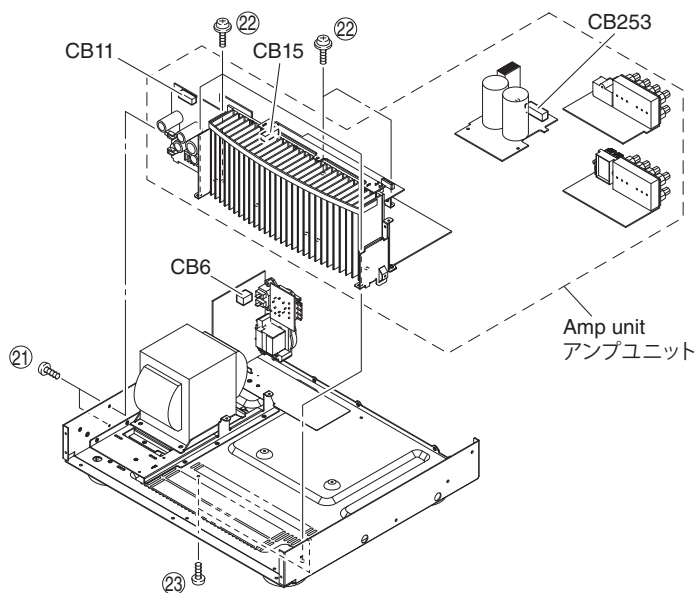

Fig. 10

When checking the P.C.B.s:

- Put the rubber sheet and the cloth over this unit. Then put the amp unit upright on the cloth and check it. (Fig. 11)
- Put the amp unit together with the heat sink upright and check. (Fig. 11)
- Reconnect all cables (connectors) that have been disconnected. Be sure to use the extension cable for servicing for the following section.
 FL (1) P.C.B. CB901—FL (2) P.C.B. CB970:
 MF126500 (26P, 500mm)
 FL (2) P.C.B. CB971—OPERATION (2) P.C.B. CB803:
 MF115500 (15P, 500mm)
 FL (1) P.C.B. W9001—POWER (1) P.C.B. CB12:
 MF405400 (5P, 400mm)
 FUNCTION (1) P.C.B. CB409—POWER (3) P.C.B. CB18:
 MF114400 (14P, 400mm)
- When connecting the flexible flat cable, be careful with polarity.
- Connect the ground point of the sub chassis unit and the amp unit to the chassis with a ground lead or the like. (Fig. 11)

P.C.B. をチェックする場合には：

- 本機の上にゴムシートと布を敷き、その上にアンプユニットを立てて置いてチェックします。(Fig. 11)
- アンプユニットはヒートシンクといっしょに立ててチェックします。(Fig. 11)
- 外したケーブル(コネクター)をすべて接続します。ただし次の区間は、サービス用延長ケーブルを使用してください。
 FL (1) P.C.B. CB901 — FL (2) P.C.B. CB970 :
 MF126500 (26P、500mm)
 FL (2) P.C.B. CB971 — OPERATION (2) P.C.B. CB803 :
 MF115500 (15P、500mm)
 FL (1) P.C.B. W9001 — POWER (1) P.C.B. CB12 :
 MF405400 (5P、400mm)
 FUNCTION (1) P.C.B. CB409 — POWER (3) P.C.B. CB18 :
 MF114400 (14P、400mm)
- フラットケーブルを接続する際、極性に注意してください。
- サブシャーシユニットとアンプユニットのアースをアース線等でシャーシに接続してください。(Fig. 11)

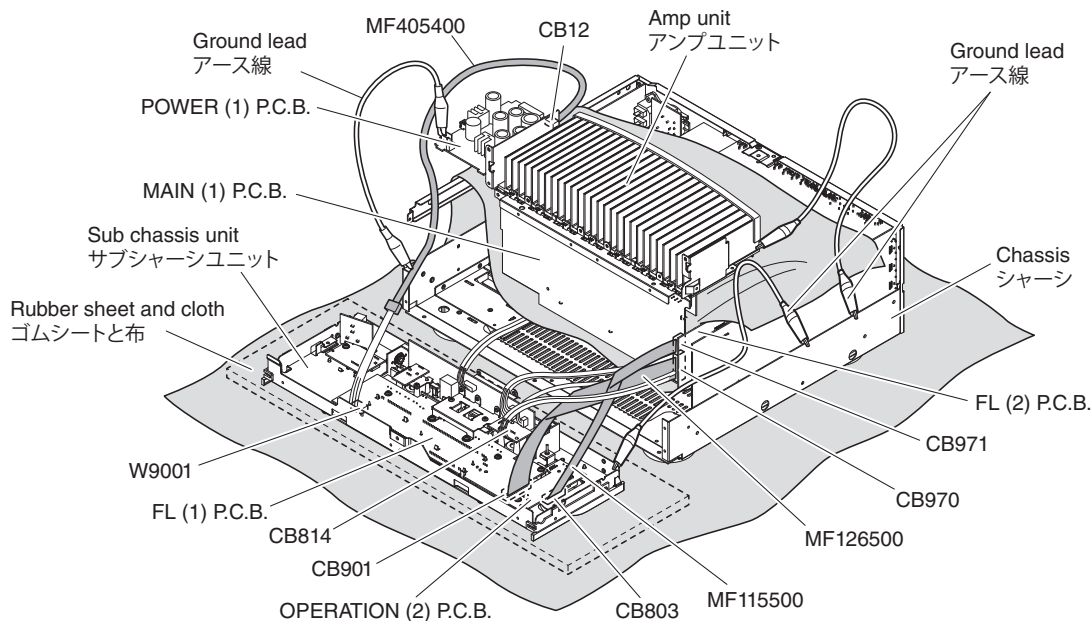

Fig. 11

■ UPDATING FIRMWARE / ファームウェアの書き込み

Note) Updating the firmware will initialize parameters, system memory, tuner presetting, etc. to the original factory settings.

When replacing the following parts, be sure to write the latest firmware.

- P.C.B. Ass'y DSP, FUNCTION, D-VIDEO or NET P.C.B.s (NET P.C.B.: R, T, K, A, B, G, E, L, J models)
- IC540 (DSP (TI) flash ROM) of DSP P.C.B.
- IC402 (Main microprocessor) of FUNCTION P.C.B.
- IC181 (Video flash ROM) of D-VIDEO P.C.B.
- IC613 (NET flash ROM) of NET P.C.B. (IC613: R, T, K, A, B, G, E, L, J models)

● Writing the Firmware

Note that the method of writing the firmware for this unit varies depending on destinations.

U, C models

- Writing method using the firmware CD: DVD/CD player and firmware can be used for writing.
- * "Writing method using the USB" cannot be used for U and C models as they have no USB terminal.

R, T, K, A, B, G, E, L, J models

- Writing method using the USB: USB flash memory can be used for writing.

注意) ファームウェアの書き込みを行うと、音場プログラムのパラメーターやシステムメモリー、チューナープリセット等はすべて工場出荷時に初期化されます。

下記の部品をサービス部品に交換した場合、最新のファームウェアの書き込みを行ってください。

- P.C.B. ASSY : DSP, FUNCTION、D-VIDEO、NET
- DSP P.C.B. : IC540 (DSP (TI) フラッシュ ROM)
- FUNCTION P.C.B. : IC402 (メインマイコン)
- D-VIDEO P.C.B. : IC181 (ビデオフラッシュ ROM)
- NET P.C.B. : IC613 (NET フラッシュ ROM)

● ファームウェアの書き込み方法

本機は仕向けによってファームウェアの書き込み方法が異なります。

U, C models

- ファームウェア CD を使用して書き込む方法: DVD/CD プレーヤーおよびファームウェア CD を使用して書き込みを行うことができます。

R, T, K, A, B, G, E, L, J models

- USB を使用して書き込む方法: USB フラッシュメモリーを使用して書き込みを行うことができます。

Writing method using the firmware CD

– U, C models –

Required tools

- DVD or CD Player with DIGITAL OUTPUT (OPTICAL or COAXIAL) terminal
- Optical cable (when OPTICAL terminal is used)
- Digital audio pin cable (when COAXIAL terminal is used)
- Firmware CD
- * To make the firmware CD, download the latest firmware from the specified download source.

ファームウェア CD を使用して書き込む方法

– U, C models –

必要なツール

- DVD または CD プレーヤー(DIGITAL OUTPUT (OPTICAL または COAXIAL) 端子付き)
- 光ファイバーケーブル (OPTICAL 端子使用時)
- デジタル音声ピンケーブル (COAXIAL 端子使用時)
- ファームウェア CD
- ※ ファームウェア CD は、最新のファームウェアを指定のダウンロード先からダウンロードして製作してください。

Operation procedures

- * Disconnect the power cable of this unit and DVD/CD player from the AC outlet.
- 1. Connect this unit and DVD/CD player as shown below. (Fig. 1)

操作方法

- ※ 本機およびDVD/CDプレーヤーの電源コードをACコンセントから抜いてください。
- 1. 本機とDVD/CDプレーヤーを下記のように接続します。(Fig. 1)

When OPTICAL IN terminal is used / OPTICAL IN 端子使用时

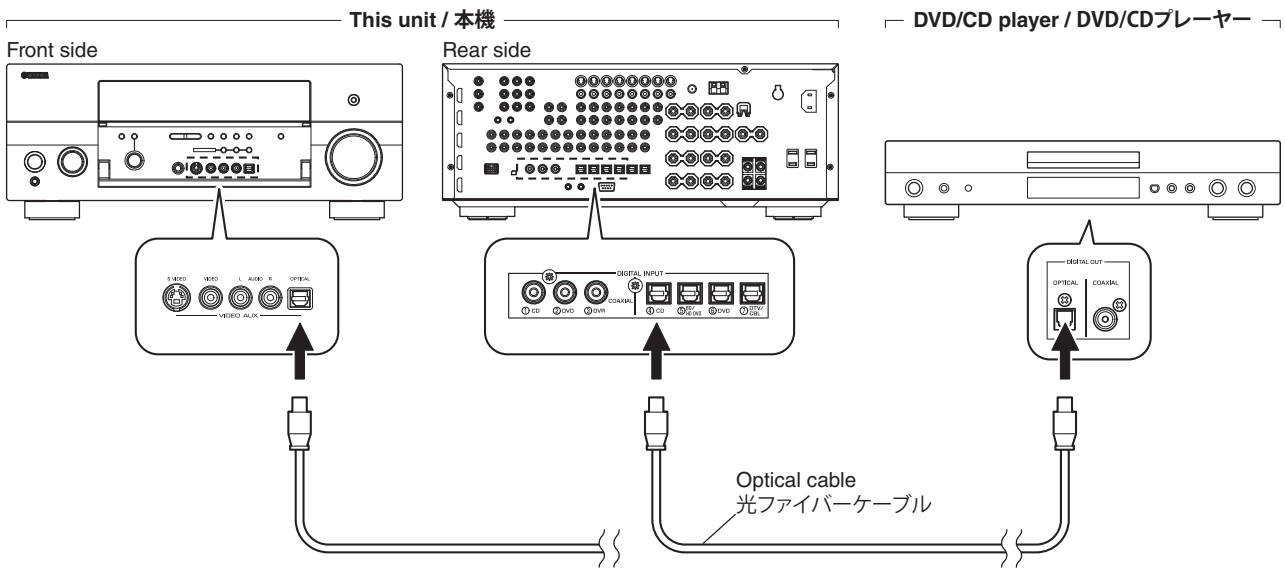

When OPTICAL IN terminal is used / OPTICAL IN 端子使用时

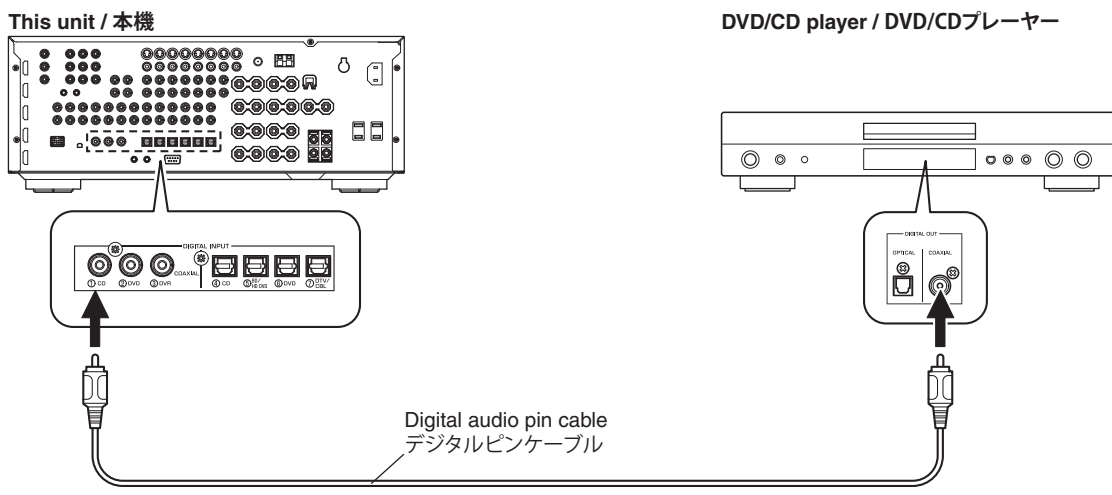

Fig. 1

- | | |
|--|---|
| <ol style="list-style-type: none"> 2. Reconnect the power cable of DVD/CD player to the AC outlet. 3. Press the "MASTER ON/OFF" key of this unit to set it to the ON state. (Fig. 2) 4. While pressing the "INFO" key of this unit, connect the power cable of this unit to the AC outlet. (Fig. 2)
<CDDA Upgrader Dest x> is displayed. (Fig. 2) | <ol style="list-style-type: none"> 2. DVD/CD プレーヤーの電源コードを AC コンセントに接続します。 3. 本機の "MASTER ON/OFF" キーを押して、ON の状態にします。 (Fig. 2) 4. 本機の "INFO" キーを押しながら、本機の電源コードを AC コンセントに接続します。 (Fig. 2)
< CDDA Upgrader Dest x >が表示されます。 (Fig. 2) |
|--|---|

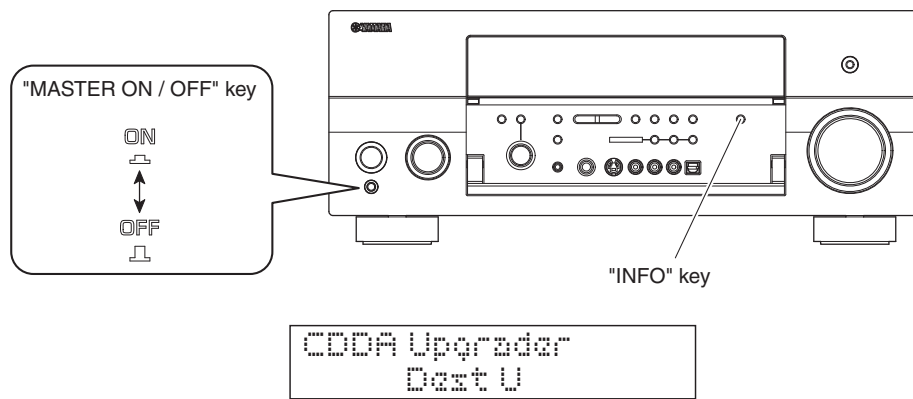

Fig. 2

- | | |
|---|---|
| <ol style="list-style-type: none"> 5. Press the "POWER ON/OFF" key of DVD/CD player to turn on the power. 6. Press the "EJECT" key of the DVD/CD player to open the disc tray. 7. Put the firmware CD on the disc tray and close the disc tray. 8. Press the "PLAY" key of the DVD/CD player. Then writing of the firmware is started. (Fig. 3) 9. When writing of the firmware is completed, <Update Success Please MASTER Off!> is displayed. (Fig. 3) <p>* If <Update Success Please MASTER Off!> is not displayed or <Error xxx> appears before coming to the end, perform steps 1 to 8 of "Operation Procedures" again.</p> | <ol style="list-style-type: none"> 5. DVD/CD プレーヤーの "POWER ON/OFF" キーを押し、電源オンします。 6. DVD/CD プレーヤーの "EJECT" キーを押し、ディスクトレイを開きます。 7. ファームウェア CD をディスクトレイにのせ、ディスクトレイを閉じます。 8. DVD/CD プレーヤーの "PLAY" キーを押します。ファームウェアの書き込みが開始されます。 (Fig. 3) 9. ファームウェアの書き込み完了後、< Update Success Please MASTER Off! >が表示されます。 (Fig. 3) <p>※ < Update Success Please MASTER Off! >が表示されない場合、または途中で< Error xxx >が表示された場合は、「操作方法」の1から8までをもう一度やり直してください。</p> |
|---|---|



Fig. 3

10. Press the "STOP" key of the DVD/CD player.
 11. Press the "EJECT" key of the DVD/CD player to open the disc tray.
 12. Remove the firmware CD from the disc tray and close the disc tray.
 13. Turn off the power of the DVD/CD player and disconnect the power cord from the AC outlet.
 14. Press the "MASTER ON/OFF" key of this unit to turn off the power.
 15. Disconnect the power cable of this unit from the AC outlet.
10. DVD/CD プレーヤーの "STOP" キーを押します。
 11. DVD/CD プレーヤーの "EJECT" キーを押し、ディスクトレイを開きます。
 12. ファームウェア CD をディスクトレイから外し、ディスクトレイを閉じます。
 13. DVD/CD プレーヤーの電源を切り、電源コードを AC コンセントから抜きます。
 14. 本機の "MASTER ON/OFF" キーを押し、電源オフします。
 15. 本機の電源コードを AC コンセントから抜きます。

Writing method using the USB

– R, T, K, A, B, G, E, L, J models –

Required tools

- USB flash memory
- Firmware (RXV1900-xxxx.bin)

Operation procedures

1. Download the latest firmware from the specified download source to PC.
2. Copy the latest firmware into the root folder of the USB flash memory.

Note) When the firmware is copied into the subfolder, it is not possible to write data in it.

USB を使用して書き込む方法

– R、T、K、A、B、G、E、L、J models –

必要なツール

- USB フラッシュメモリー
- ファームウェア (RXV1900-xxxx.bin)

操作方法

1. PC へ指定のダウンロード先から最新のファームウェアをダウンロードしてください。
2. 最新のファームウェアを USB フラッシュメモリーのルートフォルダにコピーします。

注意) ファームウェアをサブフォルダにコピーした場合、書き込みできません。

3. Connect the power cable of this unit to the AC outlet.
4. Press the "MASTER ON/OFF" key of this unit while simultaneously pressing the "STRAIGHT" key of this unit. Then the ADVANCED SETUP mode is activated. (Fig. 4)
3. 本機の電源コードを AC コンセントに接続します。
4. 本機の "STRAIGHT" キーを押しながら、"MASTER ON/OFF" キーを押し、アドバンスドセットアップを起動します。(Fig. 4)

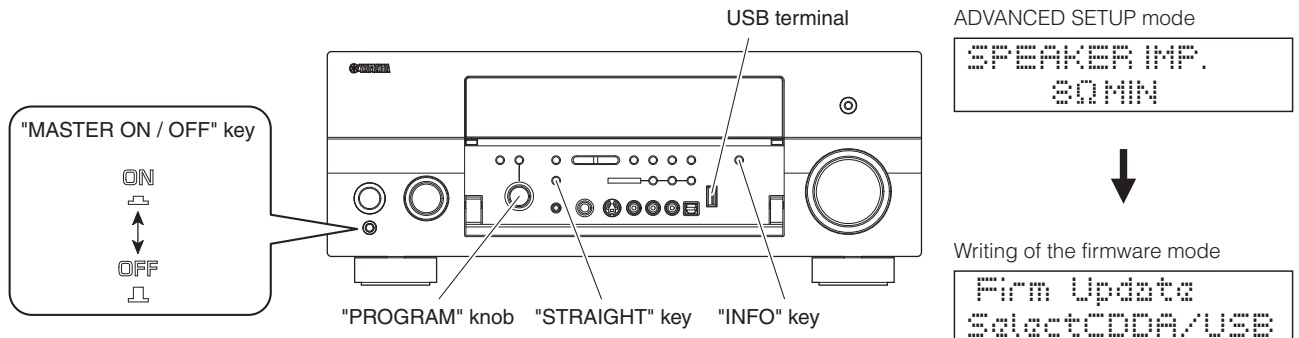

Fig. 4

5. Press and hold the "INFO" key of this unit for about 3 seconds. (Fig. 4)
Writing of the firmware is started. (Fig. 4)
6. Turn the "PROGRAM" knob to select USB.
7. Press the "INFO" key of this unit. (Fig. 4)
Writing of the firmware is set in the wait mode.
8. Insert the USB flash memory to the USB terminal of this unit. (Fig. 4)
Writing of the firmware is started.
* It takes about 10 seconds before writing is started.
5. 本機の "INFO" キーを約 3 秒間押し続けます。(Fig. 4)
ファームウェアの書き込みが起動します。(Fig. 4)
6. "PROGRAM" ツマミを回して、USB を選択します。
7. 本機の "INFO" キーを押します。(Fig. 4)
ファームウェアの書き込み待機中になります。
8. 本機の USB 端子に USB フラッシュメモリーを差し込みます。(Fig. 4)
ファームウェアの書き込みが開始されます。
※ 書き込みが開始されるまで約 10 秒間かかります。

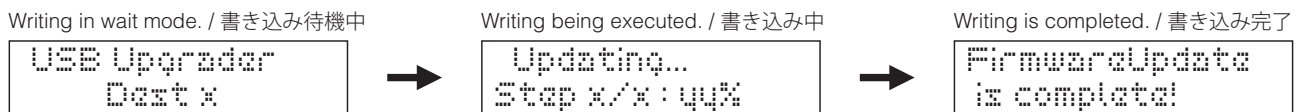

Fig. 5

9. When writing of the firmware is completed, the power of this unit turns OFF/OFF automatically.
* If <Firmware Update is complete!> is not displayed, or the error message is displayed before writing is completed, perform the operation procedures from step 1 to 8 all over again.
10. Press the "MASTER ON/OFF" key of this unit to turn off the power.
11. Disconnect the power cable of this unit from the AC outlet.
9. ファームウェアの書き込みが完了すると、自動で本機の電源がオフ/オンします。
※ < Firmware Update is complete! >が表示されない場合、または途中でエラーが表示された場合は、操作手順の 1 から 8 までをもう一度やり直してください。
10. 本機の "MASTER ON/OFF" キーを押し、電源オフします。
11. 本機の電源コードを AC コンセントから抜きます。

● Confirmation of Firmware Version and Checksum

Using the self-diagnostic function menu, check that the firmware is updated successfully. Start up the self-diagnostic function of this unit and the 29. ROM VER/SUM is displayed. For more information, refer to "SELF-DIAGNOSTIC FUNCTION".

* When the displayed firmware version and checksum are different from written ones, perform the "Writing the Firmware" procedure all over again.

● ファームウェアのバージョンおよびチェックサムの確認

ダイアグメニューでファームウェアが正しく更新されたことを確認します。本機のダイアグを起動し、29. ROM VER/SUM を表示します。ダイアグの詳細は「ダイアグ（自己診断機能）」を参照してください。

※ 表示されたファームウェアのバージョンおよびチェックサムが、書き込まれたファームウェアのバージョンおよびチェックサムと異なる場合、「ファームウェアの書き込み」をもう一度やり直してください。

29. ROM VER/SUM

```
29.ROM VER/SUM
VER:5031E
```

MAIN VERSION

The version of MAIN (IC402 FUNCTION P.C.B.) firmware is displayed.
MAIN (IC402 FUNCTION P.C.B.) のファームウェアバージョンを表示します。

```
29.ROM VER/SUM
A3255 P:07DE
```

MAIN SUM

The checksum of MAIN (IC402 FUNCTION P.C.B.) is displayed.
MAIN (IC402 FUNCTION P.C.B.) のチェックサムを表示します。
A: All area P: Program area

```
29.ROM VER/SUM
V-VER:C009
```

VIDEO VERSION

The version of VIDEO (IC147 D-VIDEO P.C.B.) firmware is displayed.
VIDEO (IC147 D-VIDEO P.C.B.) のファームウェアバージョンを表示します。

```
29.ROM VER/SUM
AF824 C:BCD1
```

VIDEO SUM 1

The checksum of VIDEO (IC147 D-VIDEO P.C.B.) is displayed.
VIDEO (IC147 D-VIDEO P.C.B.) のチェックサムを表示します。
A: All area C: CDDA boot area

```
29.ROM VER/SUM
W0000 P:EB15
```

VIDEO SUM 2

The checksum of VIDEO (IC147 D-VIDEO P.C.B.) is displayed.
VIDEO (IC147 D-VIDEO P.C.B.) のチェックサムを表示します。
W: Wall paper area (Not applied to these models. / このモデルには適用されません。) P: Program area

```
29.ROM VER/SUM
TI-VER:01C371
```

TI1 FLASH VERSION

The version of DSP1 (IC534 DSP P.C.B.) firmware is displayed.
DSP1 (IC534 DSP P.C.B.) のファームウェアバージョンを表示します。

```
29.ROM VER/SUM
T1SUM:0ED9A25AD
```

TI1 FLASH SUM (4Byte)

The checksum of DSP1 (IC534 DSP P.C.B.) is displayed.
DSP1 (IC534 DSP P.C.B.) のチェックサムを表示します。

```
29.ROM VER/SUM
XM VER: A007
```

XM VERSION (U, C models)

The version of XM firmware is displayed.
XM のファームウェアバージョンを表示します。

```
29.ROM VER/SUM
SR VER: A001
```

SIRIUS VERSION (U, C models)

The version of SIRIUS firmware is displayed.
SIRIUS のファームウェアバージョンを表示します。

```
29.ROM VER/SUM
N:VER: 1.0.0
```

Net VERSION (R, T, K, A, B, G, E, L, J models)

The version of NET firmware is displayed.
NET のファームウェアバージョンを表示します。

```
29.ROM VER/SUM
N:SUM: A9D453DA
```

Net SUM (R, T, K, A, B, G, E, L, J models)

The checksum of NET (IC613 NET P.C.B.) is displayed.
NET (IC613 NET P.C.B.) のチェックサムを表示します。

```
29.ROM VER/SUM
T2-VER:02.07r0
```

TI2 VERSION

The version of DSP2 (IC567 DSP P.C.B.) firmware is displayed.
DSP2 (IC567 DSP P.C.B.) のファームウェアバージョンを表示します。

Note: With this unit, it is possible to check the firmware version and checksum by using the ADVANCED SETUP menu.

備考: 本機には、アドバンスドセットアップのメニューからファームウェアのバージョンおよびチェックサムを確認する方法があります。

1. Press the "MASTER ON/OFF" key of this unit while simultaneously pressing the "STRAIGHT" key of this unit. Then the ADVANCED SETUP mode is activated. (Fig. 6)
2. Keep pressing the "CATEGORY / BAND" key for about 3 seconds. (Fig. 6)
"Version/Sum" is displayed.
Press the "STRAIGHT" key to change display.

1. 本機の "STRAIGHT" キーを押しながら "MASTER ON/OFF" キーを押し、アドバンスドセットアップを起動します。(Fig. 6)
2. 本機の "BAND" キーを約3秒間押し続けます。(Fig. 6)
"Version/Sum" が表示されます。
"STRAIGHT" キーを押し、表示を切り替えます。

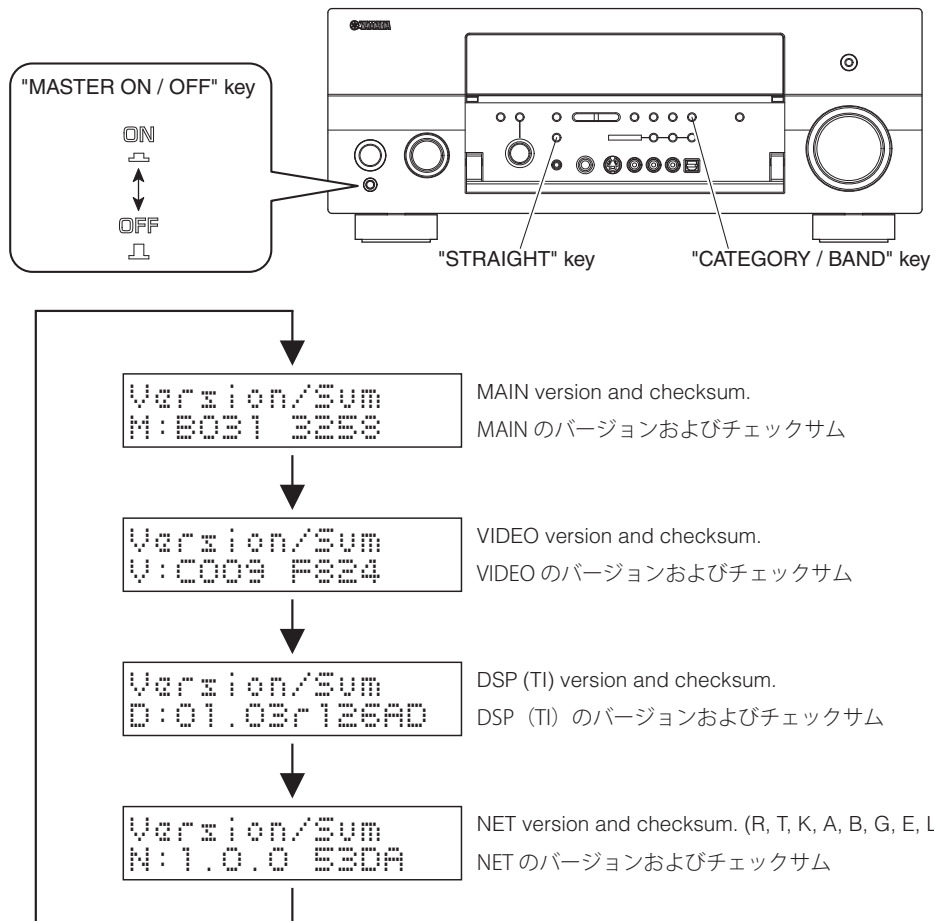

Fig. 6

3. Press the "MASTER ON/OFF" key of this unit to turn off the power.

3. 本機の "MASTER ON/OFF" キーを押し、電源オフします。

■ SELF-DIAGNOSTIC FUNCTION / ダイアグ (自己診断機能)

There are 29 main menu items, each of which has sub-menu items. Listed in the table below are menu items and sub-menu items.

メインメニューは29個あり、そのそれぞれにサブメニューがあります。下表はメニュー一覧です。

No.	MAIN MENU	SUB-MENU	INPUT SELECT
1	DSP THROUGH	1. MARGIN	-
		2. FULL BIT	
2	BYPASS	1. ANALOG BYPASS	-
		2. DSP BYPASS	
3	HDMI AUDIO	1. SPDIF	-
		2. Multi	
		3. DSD	
		4. DSD Direct	
4	SPEAKERS SET	1. FRONT:SMALL 0dB	-
		2. LFE/B:FRONT	
		3. Pres Mix:5ch	
		4. FATT1 GAIN	
		5. FATT2 GAIN	
		6. Surr B:MUTE	
		7. Surr L/R:MUTE	
		8. Zone Amp ON, Tone:MAX (U, C, R, T, K, A, B, G, E, L models)	
		9. Zone Amp ON, Tone:MIN (U, C, R, T, K, A, B, G, E, L models)	
		10. Effect Ch SML	
		11. Relay presence	
5	MULTI CH INPUT	1. 6ch INPUT_6-ohm	-
		2. 8ch INPUT_6-ohm	
		3. 6ch INPUT_8-ohm	
		4. 8ch INPUT_8-ohm	
		5. TMP TEST	
6	MIC CHECK	1. MIC CHECK	-
7	FL/OSD CHECK	1. VSYNC CHECK/VIDEO CONVERSION ON	-
		2. VFD DISP OFF/VIDEO MUTE	
		3. VFD DISP ALL/OSD CHARACTERS (0-127)	
		4. VFD DIMMER/OSD CHARACTERS (128-255)	
		5. CHECK PATTERN/VIDEO CONVERSION OFF	
8	MANUAL TEST	1. TEST ALL	BD/HD DVD (Zone 2/3)
		2. TEST FRNT L	DVD (Zone 2/3)
		3. TEST CENTER	DTV/CBL (Zone 2/3)
		4. TEST FRNT R	DVR (Zone 2/3)
		5. TEST SURR R	VCR (Zone 2/3)
		6. TEST SB R	V-AUX (Zone 2/3)
		7. TEST SB L	MD/TAPE (Zone 2/3)
		8. TEST SURR L	CD-R (Zone 2/3)
		9. TEST PRES L	CD (Zone 2/3)
		10. TEST PRES R	PHONO (Zone 2/3)
		11. TEST LFE	TUNER (Zone 2/3)
9	NO MENU (Not applied to these models. / このモデルには適用されません。)		-
10	RS-232C	1. TX DATA	-
		2. HARD FLOW	
11	AD DATA CHECK	1. DC	BD/HD DVD
		2. PS1/PS2	
		3. TM1/TM2	
		4. OUTLVL	
		5. LMTCNT	
		6. AMPRELAY	
		7. MODEL	
		8. DESTINATION	
		9. PANEL KEY (K0/K1)	
12	XM TEST TONE (U, C models)	1. 1k -1dB/44.1k	-
		2. 1k -61dB/44.1k	
		3. Mute /44.1k	
		4. XM Tone/44.1k	
		5. ISO Tone/44.1k	
		6. 1k -1dB/32k	
		7. 1k -61dB/32k	
		8. Mute /32k	
		9. XM Tone/32k	
		10. ISO Tone/32k	
		11. XM/DT Bus Power:OFF	

No.	MAIN MENU	SUB-MENU	INPUT SELECT
13	SSR STATUS (U, C models)	1. SIRIUS	SIRIUS
		2. SR	
		3. SSP	
		4. MAC	
		5. ADP	
		6. PRDID	
		7. SEQID	
14	HDR STATUS (U model)	1. CPU version 2. DIR version	-
15	DOCK	1. DOCK	DOCK
		2. BT V	
16	NO MENU (Not applied to these models. / このモデルには適用されません。)		-
17	USB CHECK (R, T, K, A, B, G, E, L, J models)	1. USB 1track	USB
		2. USB 2track	
18	PROTECTION HIST.	1. LAST	BD/HD DVD
		2. HIST1	
		3. HIST2	
		4. HIST3	
19	DSP P.C.B. CHECK	1. TI1	-
		2. TI2	
20	D-VIDEO P.C.B. CHECK	1. ALL Check	-
		2. Microprocessor/Flash Check	
		3. SPI Read Check	
21	HDMI INFO	1. HDMI Model Name	-
		2. HDMI Product ID	
		3. HDMI Vendor Name	
22	HDMI SELECT	1. HDMI NONE	-
		2. HDMI IN 1	
		3. HDMI IN 2	
		4. HDMI IN 3	
		5. HDMI IN 4	
23	HDMI UP CONV.	1. HDMI DECODER	-
		2. HDMI YGV (Not applied to these models. / このモデルには適用されません。)	
		3. HDMI I/P	
		4. HDMI 720p	
		5. HDMI 1080p	
		6. HDMI SMART ZOOM	
24	VIDEO	1. DIGITAL THR COMP	-
		2. DIGITAL THR CVBS	
		3. DIGITAL THR Y/C	
		4. DIGITAL BYPASS	
		5. ANALOG BYPASS	
		6. TEST PATTERN	
		7. VIDEO INFO	
25	FIRMWARE UPDATE (Not applied to these models. / このモデルには適用されません。)	1. MAIN	-
		2. VIDEO	
		3. TI	
		4. NET/USB	
26	SET INFO	1. MODEL	-
		2. DEST.	
27	NO MENU (Not applied to these models. / このモデルには適用されません。)		-
28	FACTORY PRESET	1. PRESET INH	-
		2. PRESET RSRV	
29	ROM VER/SUM	1. MAIN VERSION	-
		2. MAIN SUM	
		3. VIDEO VERSION	
		4. VIDEO SUM 1	
		5. VIDEO SUM 2	
		6. TI1 FLASH VERSION	
		7. TI1 FLASH SUM	
		8. XM VERSION (U, C models)	
		9. SIRIUS VERSION (U, C models)	
		10. Net VERSION (Not applied to these models. / このモデルには適用されません。)	
		11. Net SUM (Not applied to these models. / このモデルには適用されません。)	
		12. TI2 FLASH VERSION	

● Starting Self-Diagnostic Function

Press the "MASTER ON/OFF" key while simultaneously pressing those two keys of this unit as indicated in the figure below.

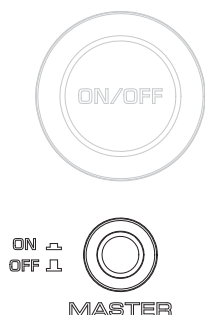

● ダイアグの起動

本機の下図に示すキーを同時に押しながら "MASTER ON/OFF" キーを押すと、ダイアグが起動します。

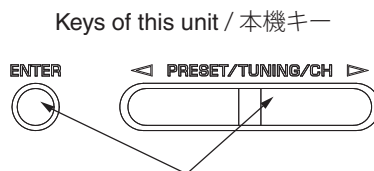

Turn on the power while pressing these keys.
これらのキーを同時に押しながら、パワーオンする。

● Starting Self-Diagnostic Function in the protection cancel mode

If the protection function works and causes hindrance to trouble shoot, cancel the protection function as described below, and it will be possible to enter the self-diagnostic function mode. (The protection functions other than the excess current detect function will be disabled.)

Press the "MASTER ON/OFF" key while simultaneously pressing those two keys indicated in the figure above. At this time, press and hold those two keys for 3 seconds or longer.

In this mode, the "SLEEP" segment of the FL display of this unit flashes to indicate that the mode is self-diagnostic function mode with the protection functions disabled.

● プロテクション解除モードでの起動

プロテクションが動作することにより、故障箇所の診断に支障をきたすような場合は、次の方法によりプロテクションを解除した状態でダイアグモードに入ることができます。(過電流検出以外のプロテクション動作を解除する)

上図のキーを同時に押しながら "MASTER ON/OFF" キーを押します。このとき、上図のキーを3秒以上押し続けてください。

このモードでは本機 FL の "SLEEP" セグメントが点滅し、プロテクションを解除した状態でのダイアグモードであることを知らせます。

CAUTION!

Using this product with the protection function disabled may cause damage to itself. Use special care when using this mode.

注意!

プロテクションを解除した状態でのダイアグモードは、危険な状態でもプロテクションが作動しないため、動作させると、機器を破壊することがあります。このモードを使用する場合は十分注意してください。

● Canceling Self-Diagnostic Function

- ① Before canceling self-diagnostic function, execute setting for PRESET of main menu No. 28 (Memory initialization inhibited or Memory initialized).
 - * In order to keep the user memory stored, be sure to select PRESET INHIBIT (Memory initialization inhibited).
- ② Turn off the power by pressing the "MASTER ON/OFF" key of this unit or the "STANDBY" key of the remote control.

● ダイアグの解除

- ① ダイアグを解除する前に、メインメニュー No. 28 の FACTORY PRESET (メモリーの初期化禁止 / またはメモリーの初期化) の設定をします。
 - ※ ユーザーメモリーを保持したい場合は、必ず PRESET INHIBIT (メモリー初期化禁止) を選択してください。
- ② 本機の "MASTER ON/OFF" キーかリモコンの "STANDBY" キーを押し、パワーオフにします。

● Display provided when Self-Diagnostic Function started

The FL display of this unit displays the protection function history data then the main menu (sub-menu MARGIN of main menu No. 1 DSP THROUGH) a few seconds later.

When there is no history of protection function:

Opening message / オープニング表示

When there is no protection history
プロテクション履歴が無い場合

DIAGNOSTIC
NO PROTECT

After a few seconds / 数秒後

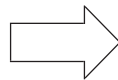

1 DSP THROUGH
MARGIN

Main menu display / メインメニュー表示

When there is a history of protection function:

When there is a history of protection function due to excess current

When there is a history of protection function due to excess current
過電流によるプロテクション履歴がある場合

DIAGNOSTIC
I PROTECT

● ダイアグ起動時の表示

本機の FL ディスプレイにプロテクション履歴情報が表示され、数秒後にメインメニュー (No. 1 DSP THROUGH のサブメニュー MARGIN) になります。

プロテクション履歴がない場合:

プロテクション履歴がある場合:

過電流によるプロテクション履歴がある場合

Cause: An excessive current flowed through the power amplifier.

Supplementary information: As current of the power transistor is detected, the abnormal channel can be identified by checking the current detect transistor.

Turning on the power without correcting the abnormality will cause the protection function to work immediately and the power supply will instantly be shut off.

原因: パワーアンプに過電流が流れた。

補足: パワートランジスタの電流を検出していますので、電流検出トランジスタをチェックすれば異常チャンネルが特定できます。

異常状態のままパワーオンすると、瞬時にプロテクションがかかり、すぐに電源が切れます。

Note)

- Applying the power to this unit without correcting the abnormality can be dangerous and cause additional circuit damage. To avoid this, if protection function has been activated 3 times continuously, the power will not turn on even when the "MASTER ON/OFF" key is pressed. In order to turn on the power again, disconnect the power cable of this unit from the AC outlet once and then reconnect it again.
- The output transistors in each amplifier channel should be checked for damage before applying power of this unit.
- Amplifier current should be monitored by measuring DC voltage across the emitter resistors for each channel.

注意!

- 異常状態のまま本機の電源を入れると、危険な状態になり、さらに回路が損傷を受ける原因になります。そのため連続してプロテクションが働いた場合、3回目以降 "MASTER ON/OFF" キーを押しても電源が入らなくなります。再度電源を入れる場合、一度本機の電源コードを AC 電源コンセントから抜いて接続し直してください。
- 本機の電源をいれる前に、各アンプのチャンネル内の出力トランジスタに損傷がないかチェックしてください。
- アンプの電流は、各チャンネルのエミッターの抵抗器間電圧を測定することによりモニターしてください。

When there is a history of protection function due to abnormal voltage in the power supply section
電源部の電圧異常によるプロテクション履歴がある場合

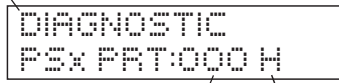

A/D conversion value of voltage
電圧の A/D 変換値

H: High
L: Low

Cause: The voltage in the power supply section is abnormal.
(Normal value: PS1 54 to 87, PS2 60 to 96)

Supplementary information: The abnormal voltage is displayed in based on 5V as 255.

Turning on the power without correcting the abnormality will cause the protection function to work 1 second later and the power supply will be shut off.

原因: 電源部の電圧が異常。
(正常値: PS1 54 ~ 87、PS2 60 ~ 96)

補足: 異常時の電圧の状態を、5V を 255 とした値で表示します。

異常状態のままパワーオンすると、1 秒後にプロテクションがかかり、電源が切れます。

When there is a history of protection function due to abnormal DC output
DC 出力異常によるプロテクション履歴がある場合



A/D conversion value of voltage
電圧の A/D 変換値

H: High
L: Low

Cause: DC output of the power amplifier is abnormal.
(Normal value: 3 to 33)

Supplementary information: The abnormal voltage is displayed in based on 5V as 255.

Turning on the power without correcting the abnormality will cause the protection function to work 3 seconds later and the power supply will be shut off.

原因: パワーアンプの DC 出力が異常。
(正常値: 3 ~ 33)

補足: 異常時の電圧の状態を、5V を 255 とした値で表示します。

異常状態のままパワーオンすると、3 秒後にプロテクションがかかり、電源が切れます。

When there is a history of protection function due to excessive heat sink temperature
放熱器の異常温度によるプロテクション履歴がある場合



A/D conversion value of voltage
電圧の A/D 変換値

H: High
L: Low

Cause: The temperature of the heat sink is excessive.
(Normal value: TMP1/TMP2 10 to 83)

Supplementary information: The abnormal voltage is displayed in based on 5V as 255.

Turning on the power without correcting the abnormality will cause the protection function to work 1 second later and the power supply will be shut off.

原因: 放熱器の温度が異常。
(正常値: TMP1/TMP2 10 ~ 83)

補足: 異常時の電圧の状態を、5V を 255 とした値で表示します。

異常状態のままパワーオンすると、1 秒後にプロテクションがかかり、電源が切れます。

* Additional causes of protection can be due to loose connections, associated components, Microprocessor, etc.

* For the protection voltage value, refer to main menu No. 11 described later.

※ 前記の異常原因の他に、コネクターのはずれやマイコン周辺などに原因がある場合があります。

※ プロテクションの電圧値に関しては、後述のメインメニュー No. 11 を参照してください。

● **History of protection function**

When the protection function has worked, its history is stored in memory with a backup. Even if no abnormality is noted while servicing the unit, an abnormality which has occurred previously can be defined as long as the backup data has been stored. The history of the protection function is cleared when self-diagnostic function is cancelled by selecting PRESET RESERVED (Memory initialized) of main menu No. 28 or when the backup data is erased.

● **プロテクションの履歴**

プロテクションが働いた場合、履歴をバックアップして記憶しています。サービスのときに異常が認められなくても、バックアップが残っていれば、お客様のところで起きた異常を区別できます。プロテクションの履歴は、メインメニュー No. 28 で PRESET RESERVED (メモリーの初期化) を選んでダイアグを解除した場合や、バックアップが消えたときにはクリアされます。

● **Display during menu operation**

During the self-diagnostic function mode, the monitor screen shows the wall paper and the selected function among following functions as a short message.

- Input selection, multi channel input
- Muting
- Master volume

The FL display of this unit shows the selected function. The displayed contents are described in the later section on details of self-diagnostic function menu.

● **メニュー動作中の表示**

ダイアグ中、モニター画面には壁紙表示と以下の動作中の機能がショートメッセージとして表示されます。

- インプット切替、マルチチャンネルインプット
- ミューティング
- マスターボリューム

本機のFLディスプレイには動作中の機能が表示されます。機能動作中の表示内容については、後述の機能詳細で記述します。

● **Operation procedure of Main menu and Sub-menu**

There are 29 menu items, each of having sub-menu items.

Main menu selection

Select the menu using "PROGRAM" knob.

Sub-menu selection

Select the sub-menu using "▷ (Forward)" and "◁ (Reverse)" keys of PRESET/TUNING.

● **メインメニューとサブメニューの操作**

ダイアグには No. 1 ~ 29 のメニューがあり、そのそれぞれにサブメニューがあります。

メインメニューの選択

PROGRAM ツマミで選択します。

サブメニューの選択

PRESET/TUNING▷(順送り), ◁(逆送り)キーで選択します。

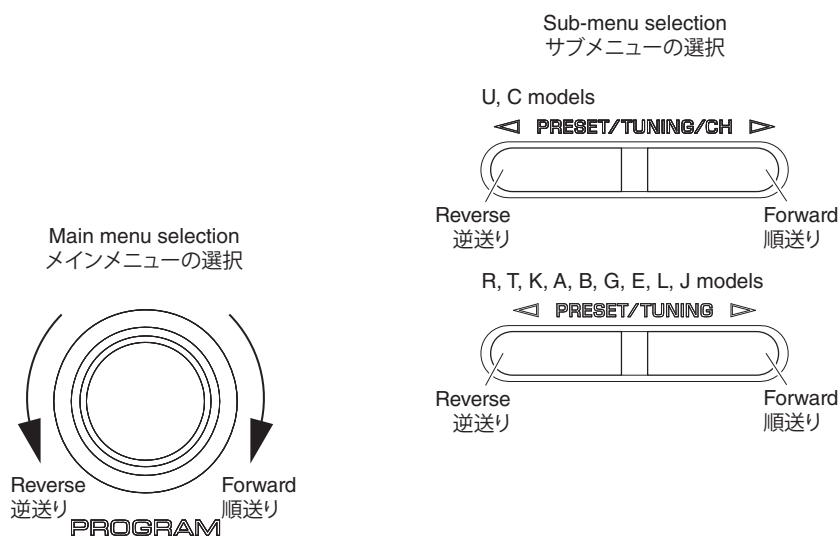

● Functions in Self-Diagnostic Function mode

In addition to the self-diagnostic function menu items, functions listed below are available.

- Input selection, Multi channel input
 - Center/Rear/Rear center/Sub-woofer level adjustment
 - Muting
 - Power on/off
 - Master volume
- * Functions related to the tuner and the set menu are not available.

● Initial settings used to start Self-Diagnostic Function

The following initial settings are used when starting self-diagnostic function. When self-diagnostic function is canceled, these settings are restored to those before starting self-diagnostic function.

- Master volume: -20dB
- Input: DVD (MULTI CHANNEL INPUT OFF)
- Effect level: 0dB
- Audio mute: OFF
- Speaker setting: LARGE / BASS OUT = BOTH
- Self-diagnostic function menu:
 1. DSP-THROUGH / MARGIN

● Input change when Main menu is selected

There are points where the input changes automatically when main menu is selected.

11. AD DATA CHECK: BD/HD DVD
13. SIRIUS: SIRIUS (U, C models)
15. DOCK: DOCK
17. USB CHECK: USB (R, T, K, A, B, G, E, L, J models)
18. PROTECTION HISTORY: BD/HD DVD

● ダイアグ中の機能

ダイアグメニューの他に、以下の機能が動作します。

- インプット切り換え、マルチチャンネルインプット
- センター、リア、リアセンター、サブウーファーレベル調整
- ミューティング
- パワーオン/オフ
- マスターボリューム

※ チューナー関連、セットメニュー関連は機能しません。

● ダイアグ開始時の初期設定

ダイアグ開始時に以下のような設定になります。ダイアグ解除時にはダイアグ開始前の状態に戻ります。

- マスターボリューム：-20dB
- インプット：DVD (マルチチャンネル INPUT オフ)
- エフェクトレベル：0dB
- オーディオミュート：オフ
- スピーカー設定：LARGE / BASS OUT=BOTH
- ダイアグメニュー：1. DSP-THROUGH / MARGIN

● メインメニュー選択時のインプット切り換え

メインメニュー選択時に、自動でインプットが切り換わる箇所があります。

11. AD DATA CHECK : BD/HD DVD
15. DOCK : DOCK
17. USB CHECK : USB (R, T, K, A, B, G, E, L, J models)
18. PROTECTION HISTORY : BD/HD DVD

● **Details of Self-Diagnostic Function menu**

With full-bit output specified in some modes, it is possible to execute 0dBFS output without head margin in each channel.

1. DSP THROUGH

This function is for DSP2 only. Main DSP of DSP2 is selected for FRONT output.

Using the sub-menu, it is possible to select 0dB output level or full-bit output.

MARGIN

- The signal is output including the head margin.

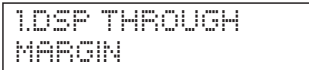

INPUT: DVD ANALOG
SPEAKER OUT: 1kHz, SUBWOOFER OUTPUT: 50Hz

Input level	Volume	SPEAKER OUT					SUBWOOFER OUTPUT
		FRONT	CENTER	SURROUND	SURROUND BACK	PRESENCE	
Both ch, -20 dBm	+6.5 dB	+12.5 dBm	+13.5 dBm	+13.5 dBm	+13.5 dBm	-∞	-5.5 dBm

FULL BIT

- The signal is output in digital full bit without including the head margin.
- The SWFR signal is output but not in digital full bit.

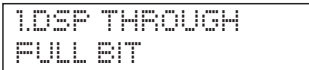

INPUT: DVD ANALOG
SPEAKER OUT: 1kHz, SUBWOOFER OUTPUT: 50Hz

Input level	Volume	SPEAKER OUT					SUBWOOFER OUTPUT
		FRONT	CENTER	SURROUND	SURROUND BACK	PRESENCE	
Both ch, -20 dBm	+6.5 dB	+12.5 dBm	+13.5 dBm	+13.5 dBm	+13.5 dBm	-∞	-5.5 dBm

DSP THROUGH
(ANALOG)

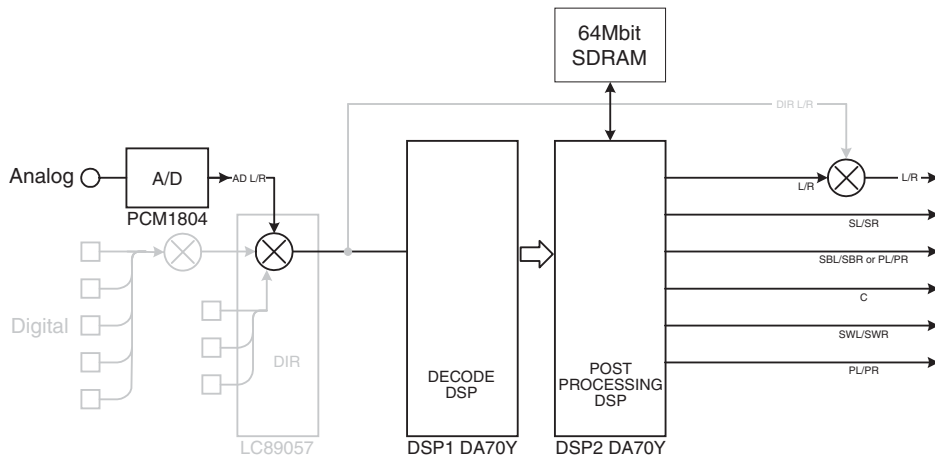

(Shaded items not used in this mode)

● **ダイアグメニュー詳細**

一部のモードでフルビット指定することで、各チャンネルのヘッドマージンを廃して 0dBFS 出力することが可能です。

1. DSP THROUGH

DSP2 のみの動作です。FRONT 出力には DSP2 の Main DSP が選択されます。

サブメニューにより、出力レベル 0dB、フルビット出力が選択可能です。

MARGIN

- ヘッドマージンを含んで出力されます。

FULL BIT

- ヘッドマージンを含まず、デジタルフルビットで出力されます。
- SWFR は出力されますが、デジタルフルビットではありません。

RX-V1900/HTR-6290/
DSP-AX1900

2. BYPASS

ANALOG BYPASS

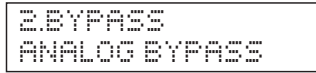

INPUT: DVD ANALOG

SPEAKER OUT: 1kHz, SUBWOOFER OUTPUT: 50Hz

Input level	Volume	SPEAKER OUT					SUBWOOFER OUTPUT
		FRONT	CENTER	SURROUND	SURROUND BACK	PRESENCE	
Both ch, -20 dBm	+6.5 dB	+12.5 dBm	-∞	-∞	-∞	-∞	-∞

DSP BYPASS

DSP BYPASS

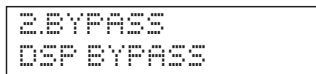

INPUT: DVD ANALOG

SPEAKER OUT: 1kHz, SUBWOOFER OUTPUT: 50Hz

Input level	Volume	SPEAKER OUT					SUBWOOFER OUTPUT
		FRONT	CENTER	SURROUND	SURROUND BACK	PRESENCE	
Both ch, -20 dBm	+6.5 dB	+12.5 dBm	-∞	-∞	-∞	-∞	-∞

ANALOG BYPASS
(ANALOG)

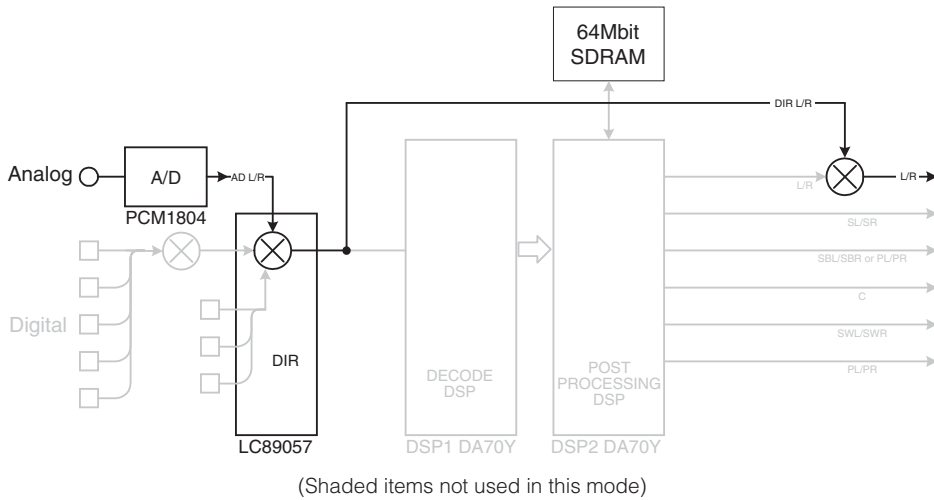

DSP BYPASS
(DIGITAL)

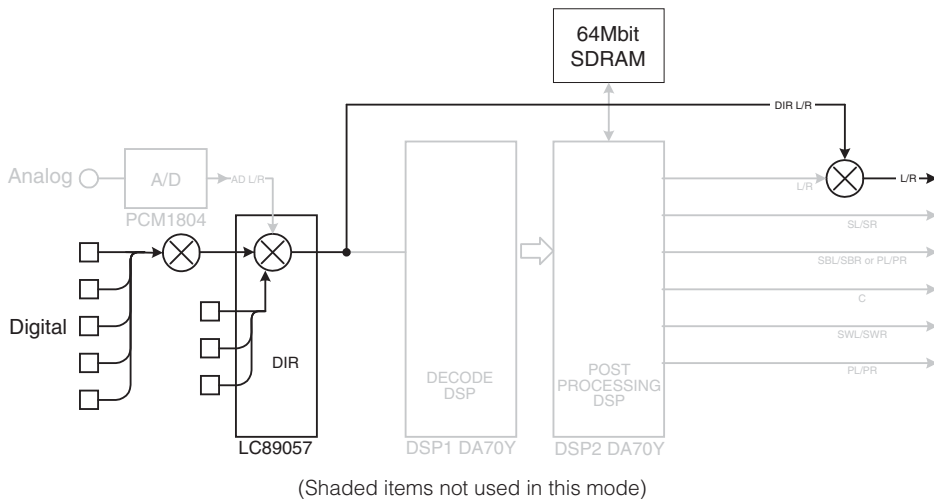

3. HDMI AUDIO

The audio signals input to HDMI IN are selected by the sub-menu and output.

* When selecting DSD or DSD Direct, be sure to connect an HDMI unit with DSD output function.

SPDIF

Only SPDIF is output.



Multi

Only Multi (DVD-AUDIO) is output.

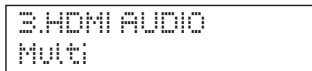

DSD

DSD (Direct Stream Digital) is output.



DSD Direct

DSD (Direct Stream Digital) is output by the direct mode.

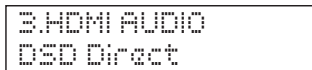

3. HDMI AUDIO

HDMI IN に入力された音声信号をサブメニューで選択し、出力します。

※ DSD および DSD Direct を選択する場合、必ず DSD 出力が可能な HDMI 機器を接続してください。

SPDIF

SPDIF のみを出力します。

Multi

Multi (DVD-AUDIO) のみを出力します。

DSD

DSD (Direct Stream Digital) を出力します。

DSD Direct

DSD (Direct Stream Digital) をダイレクトモードで出力します。

4. SPEAKERS SET

The input signal is automatically identified in the order of dts → DOLBY DIGITAL → AAC → PCM → Analog.
There are 11 sub-menu items as follows.

4. SPEAKERS SET

入力は、dts → DOLBY DIGITAL → AAC → PCM → アナログの優先順で自動判別されます。
サブメニューは以下の 11 つあります。

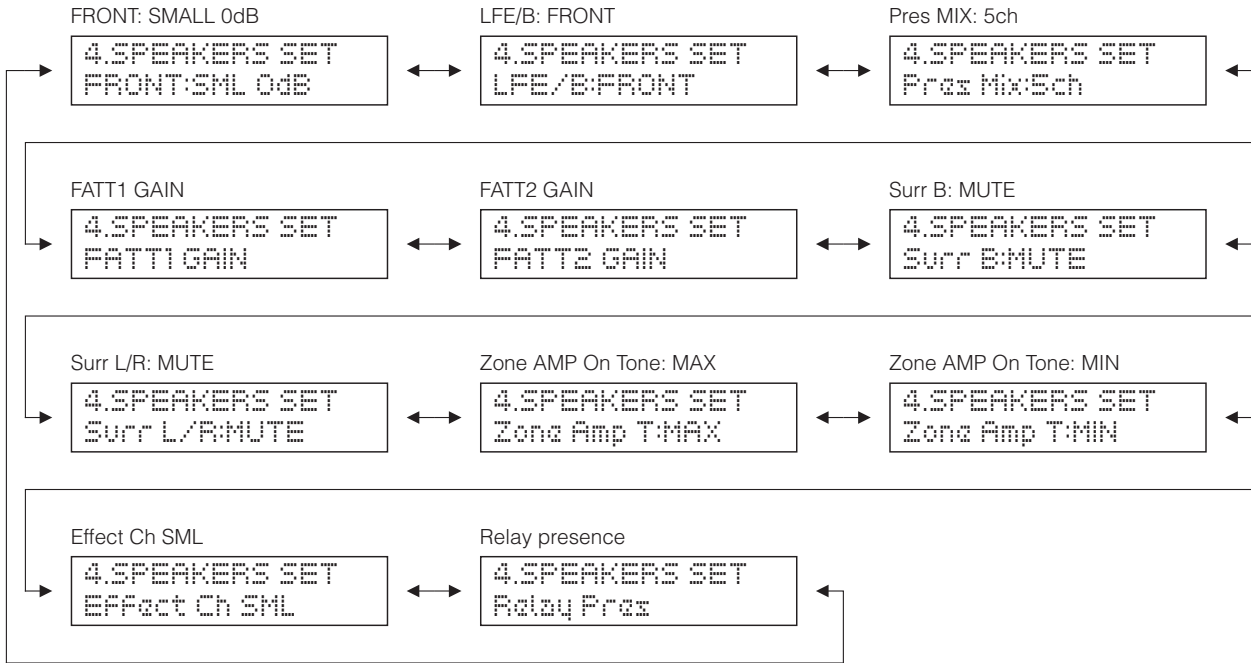

The analog switch settings for each sub-menu are as shown in the table below.

各サブメニューにおけるアナログスイッチの設定は以下の通りです。

SUB MENU	FRONT	CENTER	SURROUND	SURR. BACK	SUBWOOFER
1. FRONT: SMALL 0dB	SMALL	LARGE	LARGE	LARGE	SWFR
2. LFE/B: FRNT	LARGE	LARGE	LARGE	LARGE	FRONT
3. Pres Mix: 5ch	LARGE	LARGE	LARGE	LARGE	SWFR
4. FATT1 GAIN	LARGE	LARGE	LARGE	LARGE	SWFR
5. FATT2 GAIN	LARGE	LARGE	LARGE	LARGE	SWFR
6. Surr B: MUTE	LARGE	LARGE	LARGE	LARGE	SWFR
7. Surr L/R: MUTE	LARGE	LARGE	LARGE	LARGE	SWFR
8. Zone2/3, Zone Amp ON, Tone: Max	LARGE	LARGE	NONE	NONE	SWFR
9. Zone2/3, Zone Amp ON, Tone: Min	LARGE	LARGE	NONE	NONE	SWFR
10. EFFECT: SML 0dB	LARGE	SMALL	SMALL	SMALL	SWFR
11. Relay presence	LARGE	LARGE	LARGE	LARGE	SWFR

- LARGE: This mode is used for a speaker with high bass reproduction performance (a large unit). Full bandwidth signals are output.
- SMALL: This mode is used for a speaker with low bass reproduction performance (a small unit). The signals of 90Hz or less are mixed into the channel specified by LFE/BASS.
- NONE: This mode is used for no center speaker. The center content is reduced by 3dB and distributed to FRONT L/R.
- SWFR: LFE of 5.1ch signal or LFE/BASS lower than 90Hz is output through SUBWOOFER OUT.
- FRONT: LFE of 5.1ch signal or LFE/BASS lower than 90Hz is distributed to FRONT L/R.

- LARGE: 低音再生能力の高い（ユニットの大きい）スピーカーを使用するモードです。全帯域が出力されます。
- SMALL: 低音再生能力の低い（ユニットの小さい）スピーカーを使用するモードです。90Hz以下がLFE/BASSで指定したチャンネルにミックスされます。
- NONE: センタースピーカーを使用しないモードです。センター成分は -3dB されて、FRONT L/R に振り分けられます。
- SWFR: 5.1ch 信号の LFE または 90Hz 以下の LFE/BASS が SUBWOOFER OUT に出力されます。
- FRONT: 5.1ch 信号の LFE または 90Hz 以下の LFE/BASS を FRONT L/R に振り分けます。

INPUT: DVD ANALOG
 SPEAKER OUT: 1kHz, SUBWOOFER OUTPUT: 50Hz
 Input level: Both ch, -20 dBm
 Volume: +6.5 dB

SUB MENU	SPEAKER OUT					SUBWOOFER OUTPUT
	FRONT	CENTER	SURROUND	SURROUND BACK	PRESENCE	
1. FRONT: SMALL 0dB	+12.5 dBm	-∞	-∞	-∞	-∞	-10.5 dBm
2. LFE/B: FRNT	-∞	+13.5 dBm	+13.5 dBm	+13.5 dBm	-∞	-5.5 dBm
3. Pres Mix: 5ch	+12.5 dBm	+13.5 dBm	+18.5 dBm	-∞	-∞	-5.5 dBm
4. FATT1 GAIN	+6.5 dBm	+13.5 dBm	+13.5 dBm	+13.5 dBm	-∞	-5.5 dBm
5. FATT2 GAIN	+17.5 dBm	+13.5 dBm	+13.5 dBm	+13.5 dBm	-∞	-5.5 dBm
6. Surr B: MUTE	+12.5 dBm	+13.5 dBm	+13.5 dBm	-∞	-∞	-5.5 dBm
7. Surr L/R: MUTE	+12.5 dBm	+13.5 dBm	-∞	+13.5 dBm	-∞	-5.5 dBm
8. Zone2/3, Zone Amp ON, Tone: Max	+30.0 dBm	+13.5 dBm	-∞	-∞	+5.5 dBm	-5.5 dBm
9. Zone2/3, Zone Amp ON, Tone: Min	+30.0 dBm	+13.5 dBm	-∞	-∞	+0.5 dBm	-5.5 dBm
10. EFFECT: SML 0dB	+12.5 dBm	+13.5 dBm	+13.5 dBm	+13.5 dBm	-∞	+2.5 dBm
11. Relay presence	+12.5 dBm	+13.5 dBm	+13.5 dBm	-∞	+13.5 dBm	-5.5 dBm

5. MULTI CH INPUT

It is possible to select the 6ch/8ch input and 6-ohm/8-ohm by using the sub-menu.

6CH INPUT_6-ohm

5. MULTI CH INPUT

サブメニューにより、6ch/8ch 入力および6 オーム /8 オームが選択可能です。

6CH INPUT_6 オーム



INPUT: MULTI CH INPUT
 SPEAKER OUT: 1kHz, SUBWOOFER OUTPUT: 50Hz

Input level	Volume	SPEAKER OUT					SUBWOOFER OUTPUT
		FRONT	CENTER	SURROUND	SURROUND BACK	PRESENCE	
Both ch, -20 dBm	+6.5 dB	+12.5 dBm	+13.5 dBm	+13.5 dBm	-∞	-∞	-16.0 dBm

8CH INPUT_6-ohm

8CH INPUT_6 オーム



INPUT: MULTI CH INPUT
 SPEAKER OUT: 1kHz, SUBWOOFER OUTPUT: 50Hz

Input level	Volume	SPEAKER OUT					SUBWOOFER OUTPUT
		FRONT	CENTER	SURROUND	SURROUND BACK	PRESENCE	
Both ch, -20 dBm	+6.5 dB	+12.5 dBm	+13.5 dBm	+13.5 dBm	+13.5 dBm	-∞	-16.0 dBm

6CH INPUT_8-ohm

6CH INPUT_8 オーム



INPUT: MULTI CH INPUT
SPEAKER OUT: 1kHz, SUBWOOFER OUTPUT: 50Hz

Input level	Volume	SPEAKER OUT					SUBWOOFER OUTPUT
		FRONT	CENTER	SURROUND	SURROUND BACK	PRESENCE	
Both ch, -20 dBm	+6.5 dB	+12.5 dBm	+13.5 dBm	+13.5 dBm	-∞	-∞	-16.0 dBm

8CH INPUT_8-ohm

8CH INPUT_8 オーム



INPUT: MULTI CH INPUT
SPEAKER OUT: 1kHz, SUBWOOFER OUTPUT: 50Hz

Input level	Volume	SPEAKER OUT					SUBWOOFER OUTPUT
		FRONT	CENTER	SURROUND	SURROUND BACK	PRESENCE	
Both ch, -20 dBm	+6.5 dB	+12.5 dBm	+13.5 dBm	+13.5 dBm	+13.5 dBm	-∞	-16.0 dBm

TMP TEST/AMP. POWER CONTROL

TMP TEST:
TMP TEST, TM1 and TM2 are displayed.
AMP. POWER CONTROL:
Select the power relay H/M/L using the "STRAIGHT" key.

TMP TEST/AMP. POWER CONTROL

TMP TEST :
TMP TEST、TM1、TM2 を表示します。
AMP. POWER CONTROL :
アンプ部電源リレー H/M/L を "STRAIGHT" キーで切り替えます。

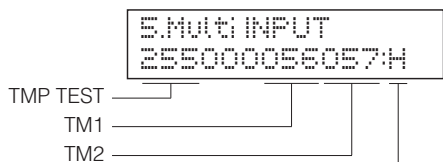

Display	RY250 (MAIN P.C.B.)	RY251 (MAIN P.C.B.)
H (HIGH)	ON	OFF
M (MID)	OFF	ON
L (LOW)	OFF	OFF

6. FL/OSD CHECK

The signals input through the microphone are output via A/D - D/A.

6. MIC CHECK

マイク入力された信号を A/D - D/A 経由で出力します。



The output level is not indicated.
出力レベルは表示されません。

7. FL/OSD CHECK

Use this program to check the FL display section and image control section. When checking the image control section, prepare a monitor, HDMI cable, component video cable, S video cable and video pin cable and connect them.

Using the sub-menu operation, the display status of the FL display section and image control section varies as shown below.

For audio signal processing, use EFFECT OFF (L/R output by using ANALOG MAIN BYPASS).

Checking FL display section

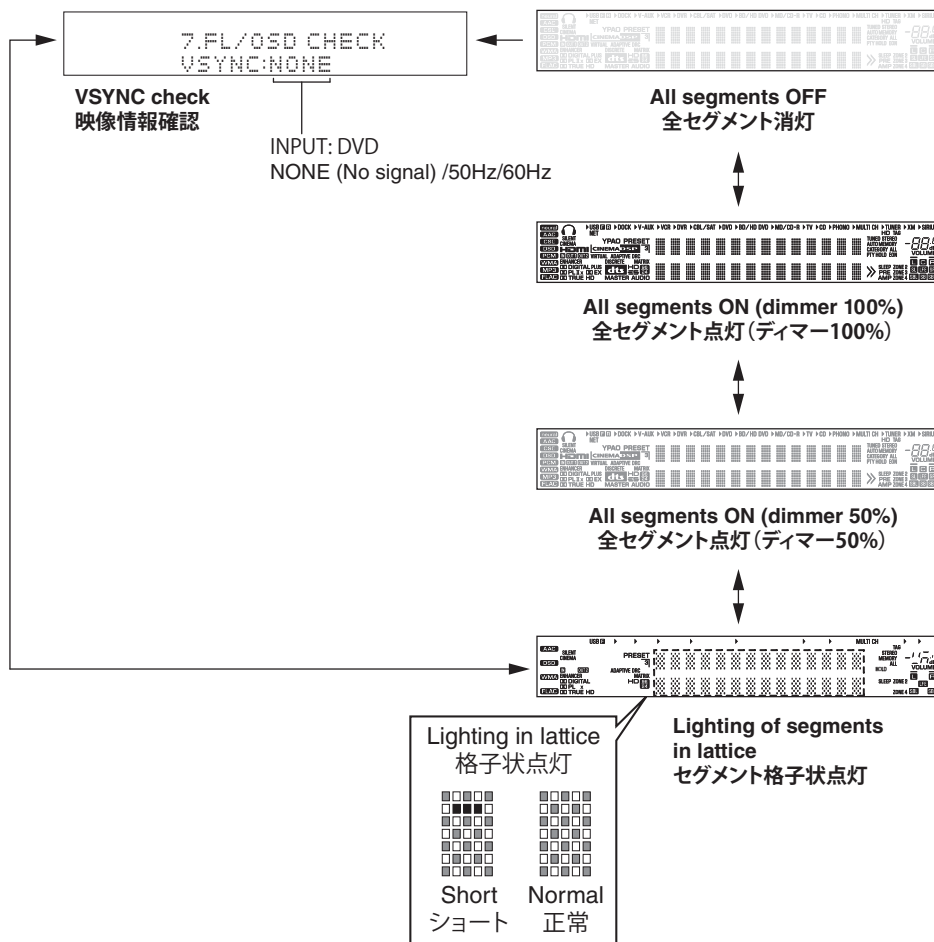

Segment conditions of the FL driver and the FL tube are checked by turning ON and OFF all segments. Next, the operation of the FL driver is checked by using the dimmer control. Then a short between segments next to each other is checked by turning ON and OFF all segments alternately (in lattice). (In the above example, the segments in the second row from the top are shorted.)

7. FL/OSD CHECK

FL 表示部と映像制御部のチェックプログラムです。映像制御部をチェックする場合には、モニター、HDMI ケーブル、D 端子ケーブル、コンポーネントビデオケーブル、S ビデオケーブル、ビデオ用ピンケーブルを準備し接続します。

サブメニュー操作により、FL 表示部と映像制御部の表示状態が以下のように連動して変わります。

オーディオ信号処理は EFFECT OFF (ANALOG MAIN BYPASS で L/R を出力) です。

FL 表示部のチェック

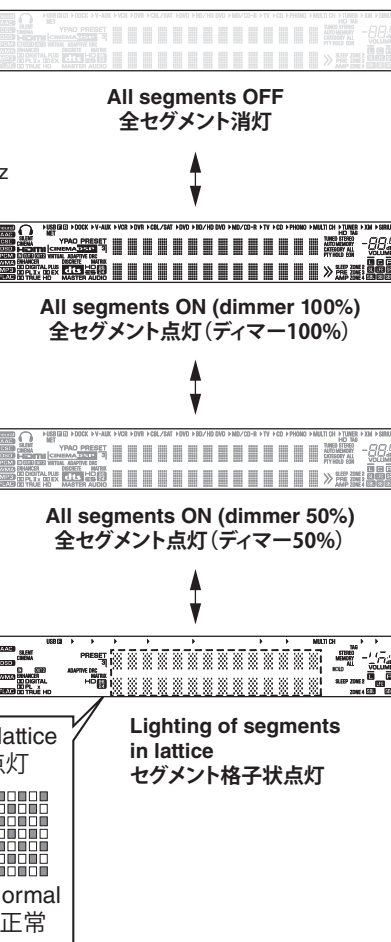

全セグメント消灯・全セグメント点灯により FL ドライバー、FL 管のセグメントの不良を確認します。次に、ディマーコントロールによって FL ドライバーの動作チェックを行います。さらに全セグメントを交互（格子状）に点灯/消灯することで、隣り合うセグメントのショートをチェックします。

Check of the Video control circuit. (Monitor out) / 映像表示部のチェック (モニター出力)

The image signal is output as follows.

映像信号は以下のように出力されます。

Initial display/Video conversion ON
初期表示 / ビデオコンバージョン ON

Video conversion ON

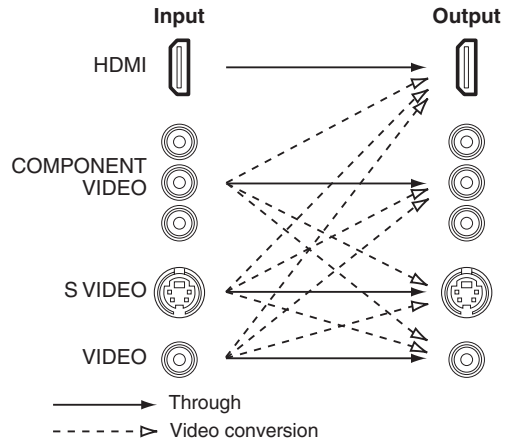

Video mute/Video conversion OFF
映像ミュート / ビデオコンバージョン OFF

Video conversion OFF

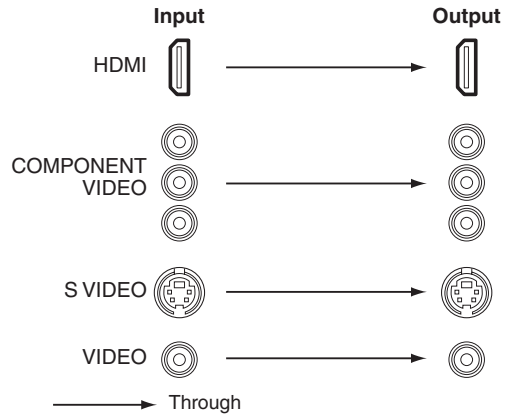

0-127 characters ON/Video conversion ON
キャラクターパターン 0-127 / ビデオコンバージョン ON

0-127 characters

OSD CHAR : 0 - 127



128-255 characters/Video conversion ON
キャラクターパターン 128-255 / ビデオコンバージョン ON

128-255 characters

OSD CHAR : 128 - 255



128-255 characters

RX-V1900/HTR-6290/
DSP-AX1900

8. MANUAL TEST

The noise generator with a built-in DSP outputs the test noise through the channels specified by the sub-menu.

The noise frequency for LFE is 30 to 80 Hz. Other than that, the noise frequency is 500 to 2 kHz.

8. MANUAL TEST

DSP 内蔵のノイズ発生回路によって、サブメニューで指定したチャンネルへテストノイズを出力します。LFE用のノイズ周波数は30～80Hz、それ以外はノイズ周波数500～2kHzとなります。

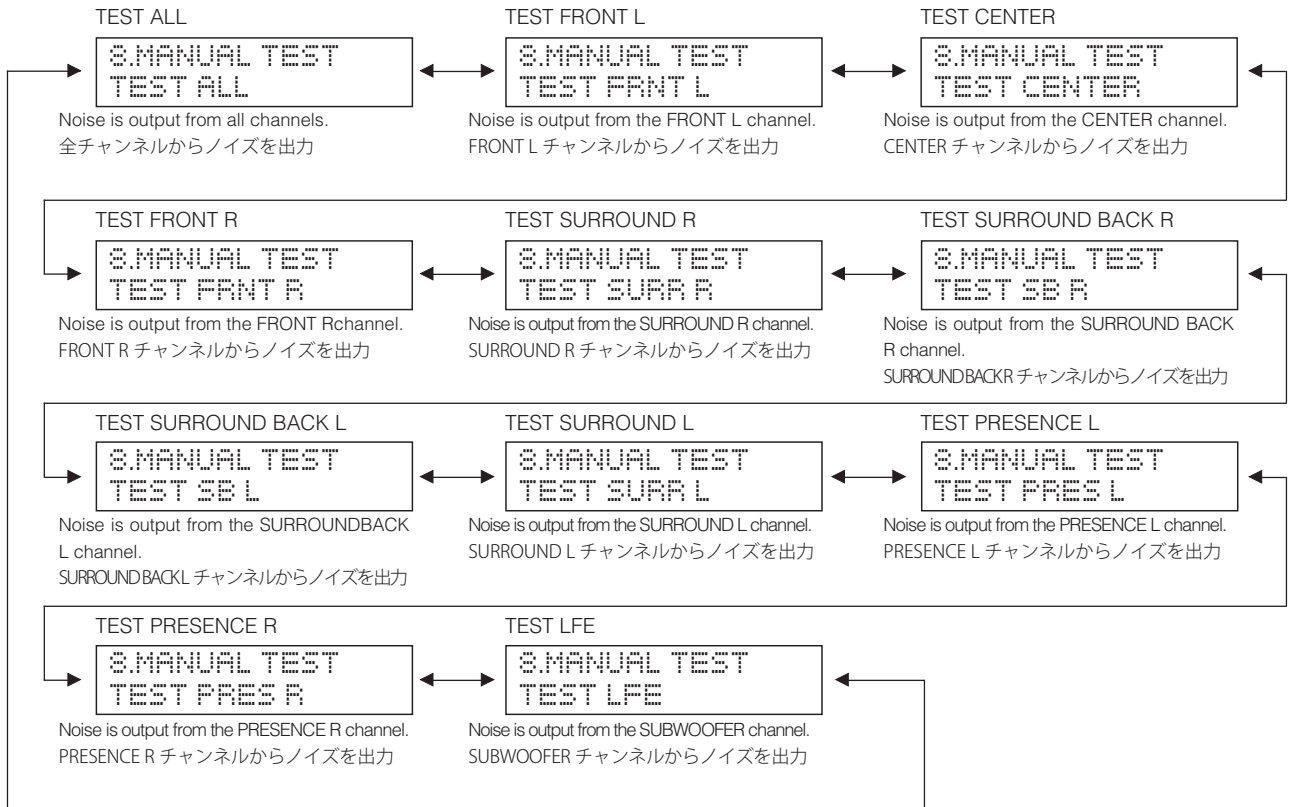

RX-V1900/HTR-6290/DSP-AX1900

9. NO MENU

Not applied to these models.

9. NO MENU

このモデルには適用されません。

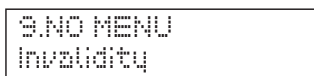

10. RS-232C

This menu is used to check transmission of the data and the flow port of the hardware.

With the power turned off, short between pins No. 2 (RxD) and No. 3 (TxD), and between pins No. 7 (RTS) and No. 8 (CTS) of the RS232C terminal. (Be sure to turn off the power when shorting the pins.)

Start self-diagnostic function and select the menu.

There are two sub-menu items.

10. RS-232C

データ送受信チェック、ハードウェアフローポートチェックを行うメニューです。

パワーオフ状態にしてから、RS232C 端子の2ピン (RxD) と3ピン (TxD)、7ピン (RTS) と8ピン (CTS) をショートさせます。(ショートさせるときは必ず電源を切ってください。)

ダイアグを起動してメニューを選択します。

サブメニューは2つあります。

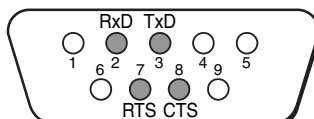

TX DATA

The sub-menu is used to check transmission of the test data. "OK" appears when the data is transmitted properly and "NG" when it is not. In this mode, NULL command transmission is continued after the test command is transmitted.

```
10.FS-232C
TX DATA:
```

TX DATA

テストの送受信チェックを行います。正常に送受信完了した場合、"OK" と表示します。正常に送受信しなかった場合は "NG" と表示します。このモードでは、テストコマンド送信後、200ms ごとに NULL コマンド（無効なコマンド）を送信し続けます。

HARD FLOW

This sub-menu is used to check operation of the flow port of the hardware. "OK" appears when the check result is satisfactory and "NG" when it is not.

```
10.FS-232C
HARD FLOW: NG
```

HARD FLOW

ハードウェアフローポートの動作チェックを行います。正常にチェック完了した場合、"OK" と表示します。正常にチェック完了しなかった場合は "NG" と表示します。

11. AD DATA CHECK

This menu is used to display the A/D conversion value of the main Microprocessor which detects panel keys of this unit and protection functions in using the sub-menu. During signal processing, the condition before execution is maintained. When K0/K1 menu is selected, keys become non-operable due to detection of the values of all keys. However, it is possible to advance to the next main menu by turning the PROGRAM knob of this unit.

* The figures in the diagram are given as reference only.

11. AD DATA CHECK

本機パネルキー、プロテクションなどを検出しているメインマイコンの A/D 変換の値を、サブメニューで表示します。信号処理は実行前の状態を維持します。K0/K1 のメニューにすると、全キーの値を検出するためキー操作はできなくなりますが、本機の PROGRAM ツマミを回すことにより、次のメインメニューに進めることができます。

※ 図中の数値は参考例です。

DC (Power supply voltage protection detection)

DC: DC detect protection value (Normal value: 3 to 33)
 * If DC is out of the normal value range, the protection function works to turn off the power.
 (Reference voltage: 5V=255)

DC (プロテクションの検出)

DC : 電源電圧プロテクションの値 (正常値 3 ~ 33)
 ※ DC は正常値を外れるとプロテクションが働き、電源オフされます。
 (基準電圧 : 5V=255)

```
11.AD CHECK
DC: 018
```

PS1/PS2 (Power supply voltage protection detection)

Power supply voltage protection value (Normal value: PS1: 54 to 87, PS2: 68 to 104)
 PS1: Detects +BDV, +BVA, +12V, -12V, +5D2, +2.5D.
 PS2: Detects +9V, +3.3VD, +5VA and -5VA.
 * If PS is out of the normal value range, the protection function works to turn off the power.
 (Reference voltage: 5V=255)

PS1/PS2 (電源電圧プロテクションの検出)

プロテクションの値 (正常値 PS1: 54-87、PS2: 60-96)
 PS1 : +BDV、+BVA、-BVA、+12V、-12V、+5D2、+2.5D を検出しています。
 PS2 : +9V、+3.3VD、+5VA、-5VA を検出しています。
 ※ PS は正常値を外れるとプロテクションが働き、電源オフされます。
 (基準電圧 : 5V=255)

```
11.AD CHECK
PS1059PS2078
```

TM1/TM2 (temperature detection)

Temperature detected value
 (Normal value: 10 to 83) U, C, R, T, K, A, B, G, E models
 (Normal value: 10 to 78) L model
 TM1: Detects the temperature of the heat sink at the left side (power transformer side)
 TM2: Detects the temperature of the heat sink at the right side (volume side)
 (Reference voltage: 5V=255)

TM1/TM2 (温度検出)

温度検出値 (正常値 10-83)
 TM1: ヒートシンク左側 (電源トランス側) の温度を検出しています。
 TM2: ヒートシンク右側 (ボリューム側) の温度を検出しています。
 (基準電圧: 5V=255)

```

    11AD CHECK
    TM1:053TM2:054
    
```

OUTLVL (Power limiter output level)

Total value of amplifier output of each channel
 The voltage at 141 pin of IC402 is displayed with 5V/255 as a standard.

OUTLVL (パワーリミッターの出力)

各チャンネルのアンプ出力の合計値
 IC402 の 141 ピンの電圧値を 5V/255 を基準にして表示します。

```

    11AD CHECK
    OUTLVL:000
    
```

LMTCNT (Limiter control value)

The voltage at 3 pin of IC402 is displayed with 5V/255 as a standard.

LMTCNT (リミッター制御の値)

IC402 の 3 ピンの電圧値を 5V/255 を基準にして表示します。

```

    11AD CHECK
    LMTCNT:255
    
```

AMPRELAY (Amp. Power relay control)

The output condition of the power relay of the amplifier section is displayed.

AMPRELAY (Amp. Power relay control)

アンプ部電源リレーの出力状態を表示します。

```

    11AD CHECK
    AMPRELAY:002
    
```

MODEL

Model detection value
 (Reference voltage: 5V=255)

MODEL

モデル検出の値
 (基準電圧: 5V=255)

```

    11AD CHECK
    MODEL:125
    
```

Model	Value
RX-V3800/DSP-AX3800	0-64
RX-V1900/DSP-AX1900	65-191
HTR-6290	192-255

DESTINATION

Destination detection value
(Reference voltage: 5V=255)

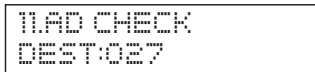

Destination	Value
J	0 ± 4
C	27 ± 4
U	54 ± 4
R	81 ± 4
T	104 ± 4

DESTINATION

仕向け検出の値
(基準電圧：5V=255)

Destination	Value
K	128 ± 4
A	152 ± 4
B, G, E	208 ± 4
L	228 ± 4

PANEL KEY (K0/K1)

(Panel key of this unit)

A/D of the key fails to function properly when the standard value is deviated by ±4. In this case, check the constant of partial pressure resistor, solder condition, etc. Refer to table.

(Reference voltage: 5V=255)

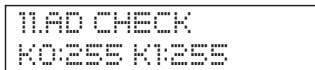

PANEL KEY (K0/K1)

(本機パネルキー)

キーのA/Dは基準値から±4を外れると、正常な動きをしません。下表をご覧になり、各キーの分圧抵抗の定数、ハンダ不良等の確認をしてください。

(基準電圧：5V=255)

RX-V1900 (U, C, R, T, K, A, B, G, E, L models)/
HTR-6290 (C, G models)

Display	K0	K1
0+4	INFO	STRAIGHT/EFFECT
26±4	ZONE CONTROLS	ENTER
51±4	CATEGORY/BAND	-
77±4	STEREO/MONO	TONE CONTROL
104±4	SEARCH MODE	AUDIO SELECT
129±4	MEMORY	PURE DIRECT
154±4	PRESET/TUNING ▷	-
179±4	◁PRESET/TUNING	-
205±4	-	-
230±4	-	-
255	KEY OFF	KEY OFF

DSP-AX1900 (J model)

Display	K0	K1
0+4	INFO	STRAIGHT/EFFECT
26±4	-	ENTER
51±4	BAND	-
77±4	STEREO/MONO	TONE CONTROL
104±4	SEARCH MODE	AUDIO SELECT
129±4	MEMORY	PURE DIRECT
154±4	PRESET/TUNING ▷	-
179±4	◁PRESET/TUNING	-
205±4	-	-
230±4	-	-
255	KEY OFF	KEY OFF

12. XM STATUS (U, C models)

The output check of XM Radio Antenna is executed.

1k -1dB/44.1k

The test tone (1kHz, -1dB/44.1kHz) is output.

```

12 XM STATUS
1k - 1dB/44
    
```

12. XM STATUS (U, C models)

1k -1dB/44.1k

1k -61dB/44.1k

The test tone (1kHz, -61dB/44.1kHz) is output.

```

12 XM STATUS
1k -61dB/44
    
```

1k -61dB/44.1k

Mute /44.1k

Nothing is output.

```

12 XM STATUS
Mute /44
    
```

Mute /44.1k

XM Tone/44.1k

The XM tone (44.1kHz) is output.

```

12 XM STATUS
XM Tone/44
    
```

XM Tone/44.1k

ISO Tone/44.1k

The ISO tone (44.1kHz) is output.

```

12 XM STATUS
ISO Tone/44
    
```

ISO Tone/44.1k

1k -1dB/32k

The test tone (1kHz, -1dB/32kHz) is output.

```

12 XM STATUS
1k - 1dB/32
    
```

1k -1dB/32k

1k -61dB/32k

The test tone (1kHz, -61dB/32kHz) is output.

```

12 XM STATUS
1k -61dB/32
    
```

1k -61dB/32k

Mute /32k

Nothing is output.

Mute /32k

```
12.XM STATUS
Mute /32
```

XM Tone/32k

The XM tone (32kHz) is output.

XM Tone/32k

```
12.XM STATUS
XM Tone/32
```

ISO Tone/32k

The ISO tone (32kHz) is output.

ISO Tone/32k

```
12.XM STATUS
ISO Tone/32
```

XM/DT Bus Power: OFF

The power of XM module is turned off.

XM/DT Bus Power: OFF

```
12.XM STATUS
Bus Power OFF
```

13. SSR STATUS (U, C models)

The SIRIUS version is displayed.

13. SSR STATUS (U, C models)

SIRIUS version

Connection of the SIRIUS antenna module connection is checked.

- OK : Normal
- NG : Abnormal
- : No connected

SIRIUS version

```
13.SSR STATUS
SIRIUS: ---
```

SR

The connection information of the SIRIUS antenna module is displayed.

SR

```
13.SSR STATUS
SR:FF 00 FF
```

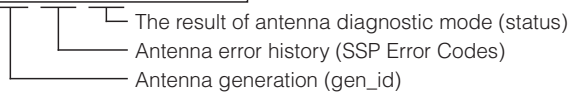

SSP

The SIRIUS version #0 (SSP) is displayed.

```
B.SSR STATUS
ESP: 00 00 00
```

SSP

MAC

The SIRIUS version #1 (MAC) is displayed.

```
B.SSR STATUS
MAC: 00 00 00
```

MAC

ADP

The SIRIUS version #2 (ADP) is displayed.

```
B.SSR STATUS
ADP: 00 00 00
```

ADP

PRDID

The PRD ID (product id) is displayed.

```
B.SSR STATUS
PRDID:00 00 00
```

PRDID

SEQID

The SEQ ID (sequence id) is displayed.

```
B.SSR STATUS
SEQID:00 00 00
```

SEQID

14. HDR STATUS (U model)

CPU version

The firmware version is displayed.

```
14.HDR STATUS
HD CPU V09.13
```

14. HDR STATUS (U model)

CPU version

DRI version

The DRI version is displayed.

```
14.HDR STATUS
D:DRI-352-V015
```

DRI version

15. DOCK

This menu is used to test the DOCK connector without the iPod itself. After turning off the power, short between pins No. 14 (TX) and No. 18 (RX), between pins No. 1 (PWR) and No. 17 (ACCPW) and between pins No. 4 (iPDET) and No. 8 (DGND). (Make sure that the power is turned off when shorting pins.) Start the self-diagnostic function and select the menu. The check result is displayed according to the following display specifications.

Note) Be sure to return the shorted pins to their original condition after executing this test.

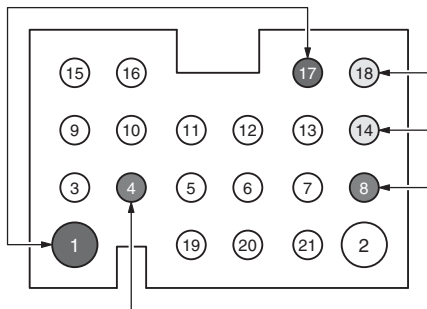

DOCK

15. DOCK

iPod 本体無しで、DOCK コネクタの検査を行うメニューです。パワーオフ状態にしてから、DOCK コネクタの 14 ピン (TX) と 18 ピン (RX)、1 ピン (PWR) と 17 ピン (ACCPW)、4 ピン (iPDET) と 8 ピン (DGND) をショートさせます。(ショートさせる時は、必ず電源を切ってください。) ダイアグを起動してメニューを選択します。下記表示仕様に従って、チェック結果が表示されま

注) 検査後、ショートしたピンを必ず元の状態に戻してください。

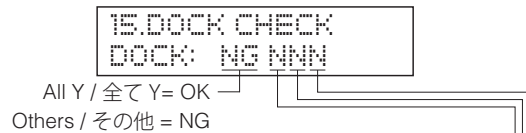

Check item / チェック項目	Judgment / 判定	Display / 表示
Is UART loop pack check result OK? / UART ループバックチェック結果は OK?	YES	Y
	NO	N
Is detect function of iPod Accessory Power OK? / iPod Accessory Power の検出機能は OK ?	IC402 (DSP P.C.B.) pin No. 95 state High = YES	Y
	IC402 (DSP P.C.B.) 95 pin の状態 Low = No	N
Is detect function of iPod installation to DOCK OK? / DOCK への iPod 装着の検出機能は OK ?	IC402 (DSP P.C.B.) pin No. 28 state Low = installed / 装着	Y
	IC402 (DSP P.C.B.) 28 pin の状態 High = not installed / 非装着	N

BT V

The DOCK (Bluetooth adapter) version is displayed.

BT V

DOCK (Bluetooth adapter) のバージョンを表示します。

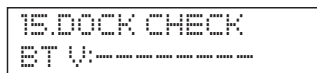

16. NO MENU

Not applied to these models.

16. NO MENU

このモデルには適用されません。

16 NO MENU
Invalidity

17. USB CHECK (R, T, K, A, B, G, E, L, J models)

The music file recorded in the USB flash memory is reproduced.

- The music file is copied into the root folder of the USB flash memory.
- Insert the USB flash memory to the USB terminal of this unit.

USB 1track

The first piece of music file is reproduced.

17. USB CHECK

USB フラッシュメモリーに記録された音楽ファイルを再生します。

- USB フラッシュメモリーのルートフォルダに（PC から）音楽ファイルをコピーします。
- USB フラッシュメモリーを本機の USB 端子に接続します。

USB 1track

音楽ファイルの 1 曲目を再生します。

17 USB CHECK
USB 1 TRACK

USB 2track

The second pieces of the music file is reproduced.

USB 2track

音楽ファイルの 2 曲目を再生します。

17 USB CHECK
USB 2 TRACK

18. PROTECTION HIST.

The history of protection function is displayed.
After selecting the sub-menu, press the "STRAIGHT" key, and the history will be erased.

18. PROTECTION HIST.

プロテクション履歴を表示します。
サブメニューを選んだ後、"STRAIGHT" キーを押すと履歴は消去されます。

Last

```
18.PRTCT HIST.
Last:NoPRT
```

Last

History1

```
18.PRTCT HIST.
Hist1:Dc 034H
```

History1

History2

```
18.PRTCT HIST.
Hist2:Dc 035H
```

History2

History3

```
18.PRTCT HIST.
Hist3:NoPRT
```

History3

19. DSP P.C.B. CHECK

Whether the bus of DSP P.C.B. is connected properly or not is self-diagnosed.

19. DSP P.S.B. CHECK

DSP P.C.B. のバス接続の正否を自己診断します。

TI1 (DSP1) BUS

TI1 (DSP1, IC534) data bus check is executed.

TI1 (DSP1) BUS

TI1 (DSP1、IC534) のデータバスチェックを行います。

```
19.DSP CHECK
TI1 BUS:NoEr
```

TI2 (DSP2) BUS

TI2 (DSP2, IC567) data bus check is executed.

TI2 (DSP2) BUS

TI2 (DSP2、IC567) のデータバスチェックを行います。

```
19.DSP CHECK
TI2 BUS:NoEr
```

Display	Description
WAIT	Bus is being checked.
NoEr	No error detected.
DATA	Data bus shorted or open.
RSCS	/RAS or /CAS shorted, or open.
ADDR	Address bus shorted or open.

表示	判断
WAIT	バスチェック中
NoEr	不良検出なし
DATA	データバスの短絡・解放
RSCS	/RAS または /CAS の短絡・解放
ADDR	アドレスバスの短絡・解放

20. D-VIDEO P.C.B. CHECK

Whether the bus of D-VIDEO P.C.B. is connected properly or not is self-diagnosed.

ALL Check

The synthetic judgment result is displayed.

- OK : No error detected
- NG : An error is detected
- No Check : Detection is not executed

```
20.DVIDEO CHK
ALL:OK
```

Microprocessor/Flash Check

The data bus check of Microprocessor (IC182) and Flash (IC181) is executed.

- OK : No error detected
- NG : An error is detected

```
20.DVIDEO CHK
M:OK F:OK
```

SPI Read Check

The Line check of SPI is executed.

- OK : 0
- NG : 1

```
20.DVIDEO CHK
SPI:00000000
```

20. D-VIDEO P.C.B. CHECK

D-VIDEO P.C.B. のバス接続の正否を自己診断します。

ALL Check

総合判定結果を表示します。

- OK : 不良検出なし
- NG : 不良検出あり
- No Check : 未検出

Microprocessor/Flash Check

マイコン (IC182) とフラッシュ (IC181) のデータバスチェックを行います。

- OK : 不良検出なし
- NG : 不良検出あり

SPI Read Check

SPI ラインのチェックを行います。

- OK : 0
- NG : 1

21. HDMI INFORMATION

HDMI Model Name

The model name of this unit written in HDMI module is displayed.

RX-V1900
HTR-6290

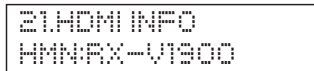

```
21 HDMI INFO
RX-V1900
```

HDMI Product ID

The product ID of this unit written in HDMI module is displayed.

312D: RX-V1900
312E: HTR-6290



```
21 HDMI INFO
312E
```

HDMI Vendor Name

The vendor name (YAMAHA) of this unit written in the HDMI module is displayed.

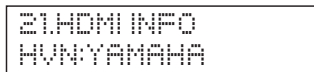

```
21 HDMI INFO
YAMAHA
```

21. HDMI INFORMATION

HDMI Model Name

HDMI モジュールに書き込まれている本機のモデル名を表示します。

DSP-AX1900

HDMI Product ID

HDMI モジュールに書き込まれている本機のプロダクト ID を表示します。

312C : DSP-AX1900

HDMI Vendor Name

HDMI モジュールに書き込まれている本機のベンダ名 (YAMAHA) を表示します。

22. HDMI SELECT**HDMI NONE**

HDMI input is not selected.

```
22.HDMI SELECT
HDMI NONE
```

HDMI IN 1: HDMI IN 1 Port

The HDMI device connected to HDMI IN 1 terminal is selected for input and HDMI is reproduced.

With the audio input terminal selection set to HDMI (Fix), it is selected automatically according to the audio format which is used for HDMI input.

Support Audio is set to "others".

22. HDMI SELECT**HDMI NONE**

HDMI 入力を選択しません。

HDMI IN 1 : HDMI IN 1 Port

HDMI IN 1 端子に接続したHDMI機器を入力セレクトして、HDMI 再生します。

音声入力端子切替は、HDMI (Fix) に設定し、HDMI 入力した音声フォーマットを自動で切り替えます。

対応音声 (Support Audio) を、その他の機器 (others) に設定します。

```
22.HDMI SELECT
HDMI IN 1
```

HDMI IN 2: HDMI IN 2 Port

The HDMI device connected to HDMI IN 2 terminal is selected for input and HDMI is reproduced.

With the audio input terminal selection set to HDMI (Fix), it is selected automatically according to the audio format which is used for HDMI input.

Support Audio is set to "others".

HDMI IN 2 : HDMI IN 2 Port

HDMI IN 2 端子に接続したHDMI機器を入力セレクトして、HDMI 再生します。

音声入力端子切替は、HDMI (Fix) に設定し、HDMI 入力した音声フォーマットを自動で切り替えます。

対応音声 (Support Audio) を、その他の機器 (others) に設定します。

```
22.HDMI SELECT
HDMI IN 2
```

HDMI IN 3: HDMI IN 3 Port

The HDMI device connected to HDMI IN 3 terminal is selected for input and HDMI is reproduced.

With the audio input terminal selection set to HDMI (Fix), it is selected automatically according to the audio format which is used for HDMI input.

Support Audio is set to "others".

HDMI IN 3 : HDMI IN 3 Port

HDMI IN 3 端子に接続したHDMI機器を入力セレクトして、HDMI 再生します。

音声入力端子切替は、HDMI (Fix) に設定し、HDMI 入力した音声フォーマットを自動で切り替えます。

対応音声 (Support Audio) を、その他の機器 (others) に設定します。

```
22.HDMI SELECT
HDMI IN 3
```

HDMI IN 4: HDMI IN 4 Port

The HDMI device connected to HDMI IN 4 terminal is selected for input and HDMI is reproduced.

With the audio input terminal selection set to HDMI (Fix), it is selected automatically according to the audio format which is used for HDMI input.

Support Audio is set to "others".

HDMI IN 4 : HDMI IN 4 Port

HDMI IN 4 端子に接続したHDMI機器を入力セレクトして、HDMI 再生します。

音声入力端子切替は、HDMI (Fix) に設定し、HDMI 入力した音声フォーマットを自動で切り替えます。

対応音声 (Support Audio) を、その他の機器 (others) に設定します。

```
22.HDMI SELECT
HDMI IN 4
```

23. HDMI UP CONV.

The image signal is converted and output to HDMI OUT as follows.

HDMI DECODER

23.HDMI UP CONV
HDMI DECODER

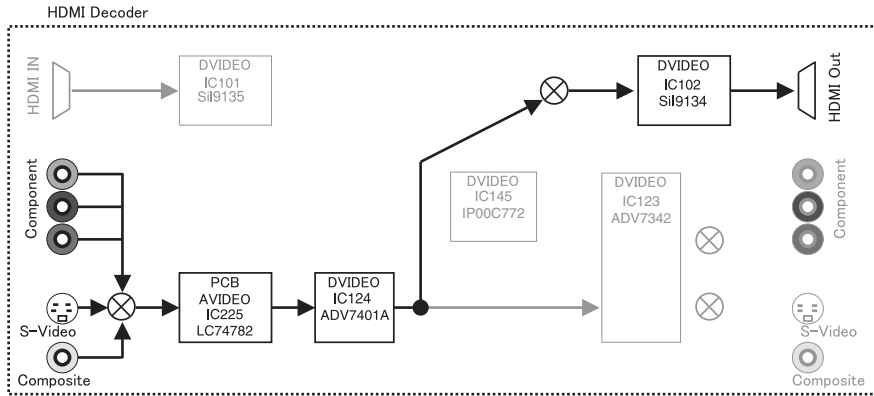

23. HDMI UP CONV.

映像信号が以下のように変換され、HDMI OUT に出力されます。

HDMI DECODER

HDMI YGV

Not applied to these models.

HDMI YGV

このモデルには適用されません。

23.HDMI UP CONV
HDMI YGV

HDMI I/P

HDMI I/P

23.HDMI UP CONV
HDMI I/P

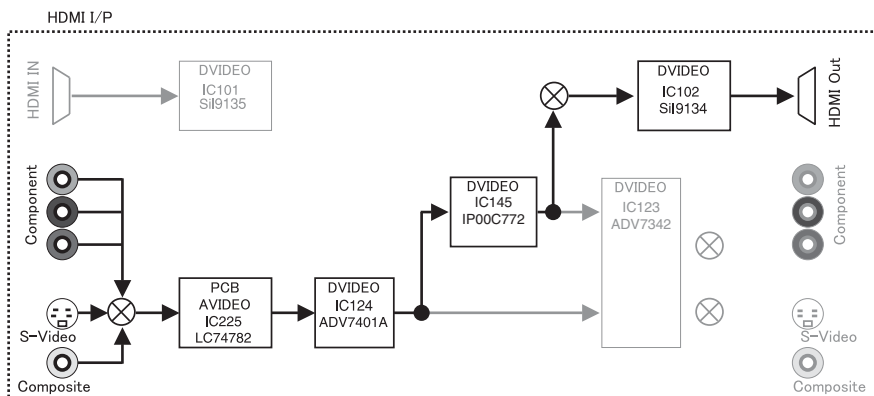

HDMI 720p

HDMI 720p

23.HDMI UP CONV
HDMI 720p

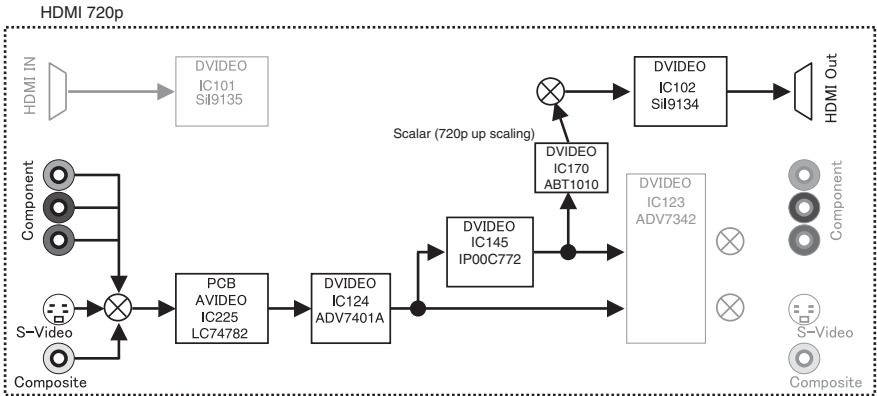

HDMI 1080p

HDMI 1080p

23.HDMI UP CONV
HDMI 1080p

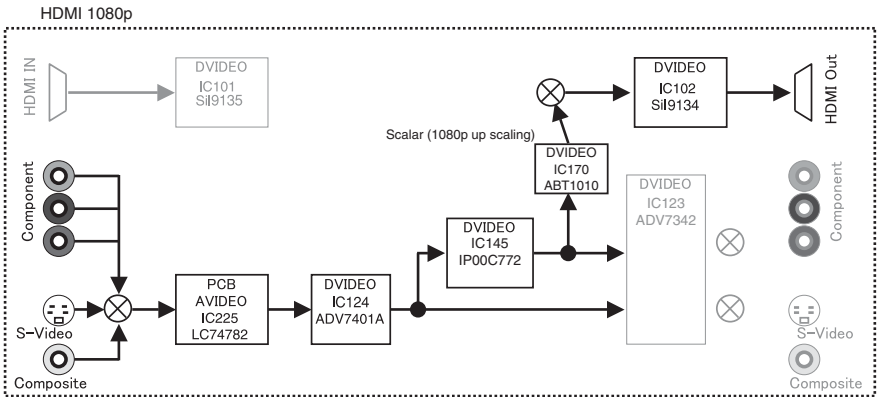

HDMI SMART ZOOM

HDMI SMART ZOOM

23.HDMI UP CONV
SMART ZOOM

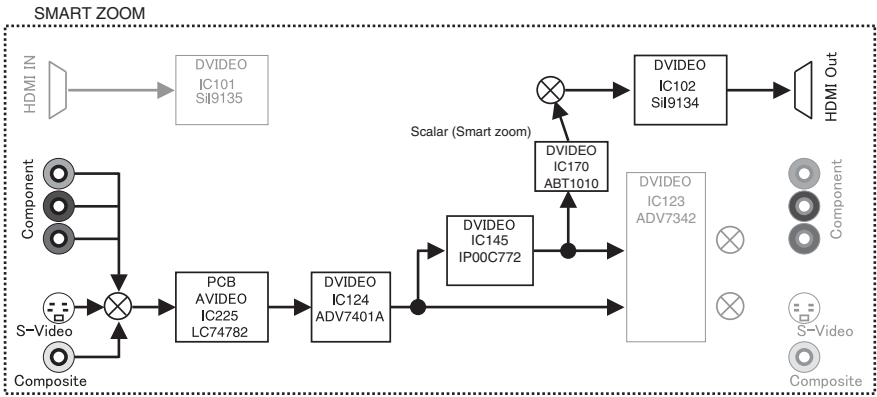

RX-V1900/HTR-6290/
DSP-AX1900

24. VIDEO

The image signal is converted and output as follows.

DIGITAL THR COMP

* The image signal 480P/580P is not output at S-VIDEO output and COMPOSITE output terminals.

24. VIDEO

映像信号が以下のように変換され、出力されます。

DIGITAL THR COMP

* S-VIDEO 出力、および COMPOSITE 出力端子へ映像信号 480P/580P は出力されません。

RX-V1900/HTR-6290/
DSP-AX1900

24 VIDEO
DIGITAL COMP

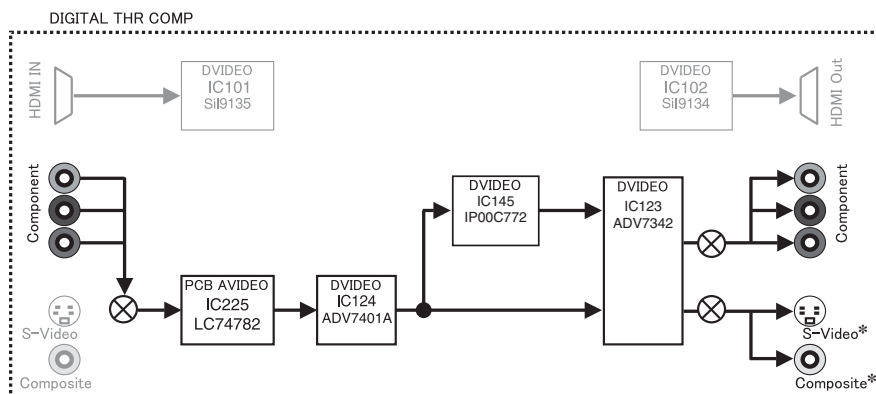

DIGITAL THR CVBS

DIGITAL THR CVBS

24 VIDEO
DIGITAL CVBS

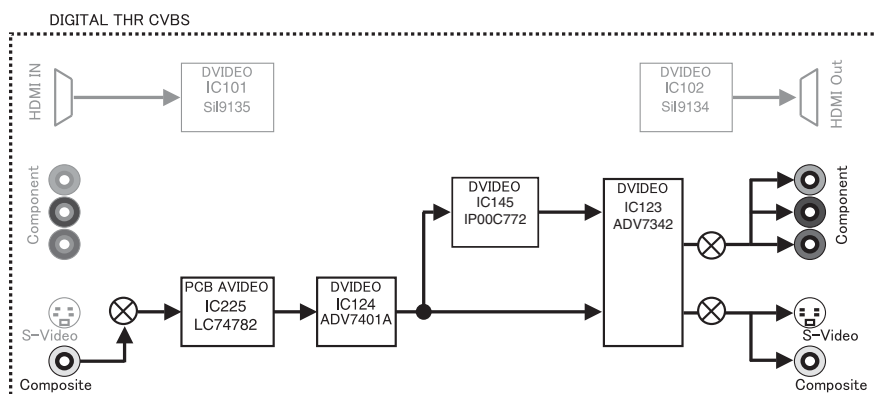

DIGITAL THR Y/C

DIGITAL THR Y/C

24.VIDEO
DIGITAL Y/C

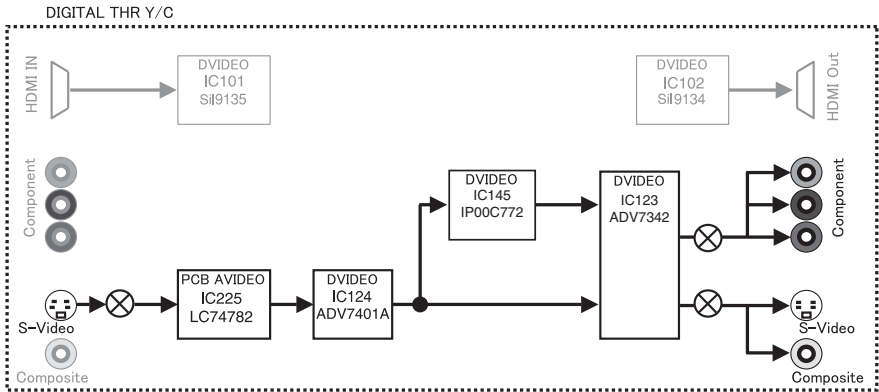

DIGITAL BYPASS

DIGITAL BYPASS

24.VIDEO
DIGITAL BYPASS

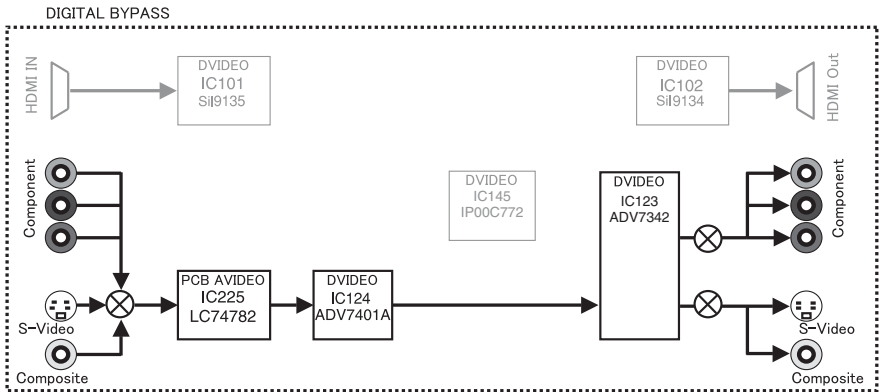

ANALOG BYPASS

ANALOG BYPASS

24.VIDEO
ANALOG BYPASS

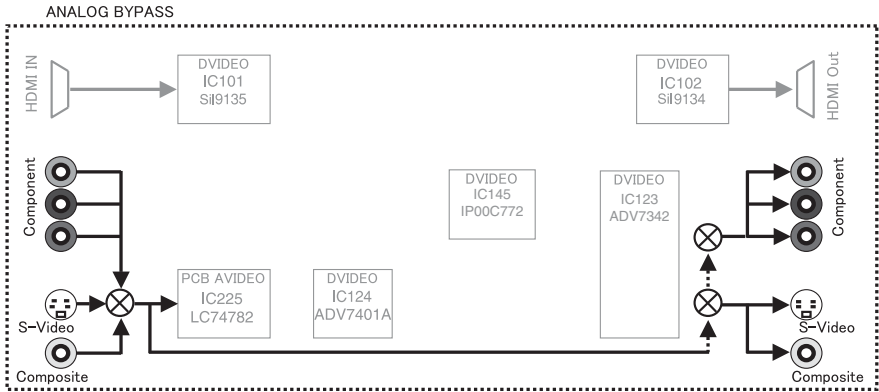

RX-V1900/HTR-6290/
DSP-AX1900

TEST PATTERN

TEST PATTERN

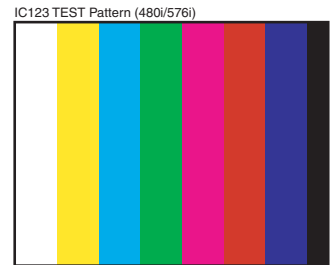
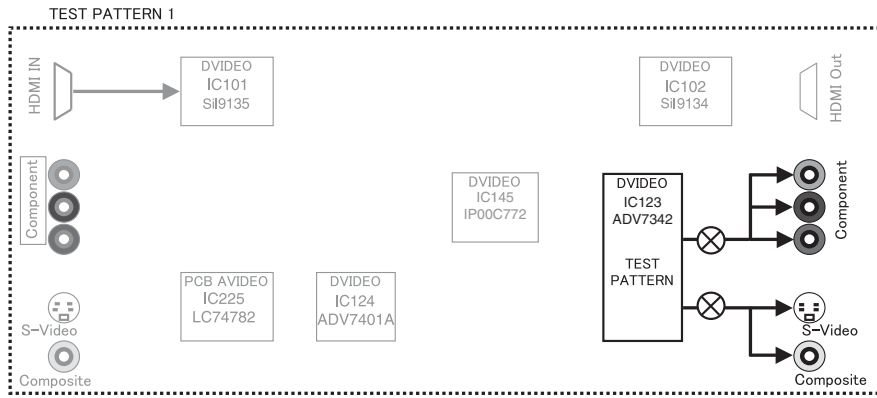

VIDEO INFO

Displays the information of image signals being input.

VIDEO INFO

入力されている映像信号の情報を表示します。

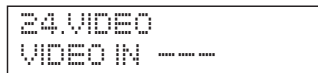

25. Firm UPDATE

Select this when writing the firmware.
(Not applied to these models.)

MAIN

```
25.Firm UPDATE
MAIN
```

VIDEO

```
25.Firm UPDATE
VIDEO
```

TI

```
25.Firm UPDATE
TI
```

NET/USB

```
25.Firm UPDATE
NET/USB UPDATE
```

26. SET INFO

The information on the model and destination is displayed.

MODEL: V1900 or 6290

```
26.SET INFO
MODEL:V1900
```

DEST.: J, UC, R, T, K, A, BGE, L

J, UC, R, T, K, A, BGE or L is displayed.

```
26.SET INFO
DEST:U
```

VERIFY

Not applied to these models.

```
26.SET INFO
VERIFY:255
```

25. Firm UPDATE

ファームウェアの書き込み時に選択します。
(このモデルには適用されません。)

MAIN

VIDEO

TI

NET/USB

26. SET INFO

モデル、仕向けの情報を表示します。

MODEL: AX1900

DEST. : J, UC, R, T, K, A, BGE, L

J, UC, R, T, K, A, BGE, L のいずれかを表示します。

VERIFY

このモデルには適用されません。

27. NO MENU

27. NO MENU

28. FACTORY PRESET

This menu is used to reserve and inhibit initialization of the back-up RAM. The signals are processed using EFFECT OFF. (The L/R signal is output using ANALOG MAIN BYPASS.)

28. FACTORY PRESET

バックアップ用 RAM (音場プログラムのパラメーターやセットメニュー内容等) の初期化を予約 / 禁止します。
信号処理は EFFECT OFF と同じです。(ANALOG MAIN BYPASS で L/R を出力)

28.FAC PRESET
PRESET INH

PRESET INHIBIT (Initialization inhibited) / PRESET INHIBIT (初期化禁止)

RAM initialization is not executed. Select this sub-menu to protect the values set by the user.

RAM の初期化は行われません。ユーザーの設定値を保護するときは、こちらを選択してください。



28.FAC PRESET
PRESET RSRV

PRESET RESERVED (Initialization reserved) / PRESET RESERVED (初期化予約)

Initialization of the back-up RAM is reserved. (Actually, initialization is executed the next time that the power is turned on.) Select this sub-menu to reset to the original factory settings or to reset the RAM. Any protection history will be cleared.

バックアップ RAM の初期化が予約されます。(実際に初期化されるのは、次回の電源投入時です。)工場出荷時や RAM をリセットしたいときは、こちらを選択してください。

CAUTION: Before setting to the PRESET RESERVED, write down the existing preset memory content of the Tuner in a table as shown below. (This is because setting to the PRESET RESERVED will cause the user memory content to be erased.)

注意： PRESET RESERVED を選んで初期化をする前に、チューナーのユーザーメモリー内容を下表に書き写してください。(初期化をすると、ユーザーメモリーの内容は消えてしまいます。)

Preset group	P1	P2	P3	P4	P5	P6	P7	P8
A								
B								
C								
D								
E								

• PRESET STATIONS / プリセット局

STATION		FM FACTORY PRESET DATA (MHz)			
PAGE	NO.	U, C	R, T, K, A, B, G, E, L	J	
A/C/E	1	87.5	87.50	76.0	
	2	90.1	90.10	83.0	
	3	95.1	95.10	84.0	
	4	98.1	98.10	86.0	
	5	107.9	108.00	90.0	
	6	88.1	88.10	78.0	
	7	106.1	106.10	88.0	
	8	107.9	108.00	82.1	

STATION		AM FACTORY PRESET DATA (kHz)		
PAGE	NO.	U, C, R, T, K	A, B, G, E, L	J
B/D	1	630	630	630
	2	1080	1080	1080
	3	1440	1440	1440
	4	530	531	531
	5	1710	1611	1611
	6	900	900	900
	7	1350	1350	1350
	8	1400	1404	1404

29. ROM VER/SUM

The version and checksum are displayed. The signal is processed using EFFECT OFF. The checksum is obtained by adding the data at every 8 bits for each program area and expressing the result as a 4-figure hexadecimal data.

```
29 ROM VER/SUM
VER:BO3E
```

MAIN VERSION

The version of MAIN (IC402 FUNCTION P.C.B.) firmware is displayed.
MAIN (IC402 FUNCTION P.C.B.) のファームウェアバージョンを表示します。

```
29 ROM VER/SUM
A3253 P:07DE
```

MAIN SUM

The checksum of MAIN (IC402 FUNCTION P.C.B.) is displayed.
MAIN (IC402 FUNCTION P.C.B.) のチェックサムを表示します。
A: All area P: Program area

```
29 ROM VER/SUM
V-VER:C009
```

VIDEO VERSION

The version of VIDEO (IC147 D-VIDEO P.C.B.) firmware is displayed.
VIDEO (IC147 D-VIDEO P.C.B.) のファームウェアバージョンを表示します。

```
29 ROM VER/SUM
AF324 C:BCD1
```

VIDEO SUM 1

The checksum of VIDEO (IC147 D-VIDEO P.C.B.) is displayed.
VIDEO (IC147 D-VIDEO P.C.B.) のチェックサムを表示します。
A: All area C: CDDA boot area

```
29 ROM VER/SUM
W:0000 P:EB1E
```

VIDEO SUM 2

The checksum of VIDEO (IC147 D-VIDEO P.C.B.) is displayed.
VIDEO (IC147 D-VIDEO P.C.B.) のチェックサムを表示します。
W: Wall paper area (Not applied to these models. / このモデルには適用されません。)
P: Program area

```
29 ROM VER/SUM
TI-VER:010371
```

T11 FLASH VERSION

The version of DSP1 (IC534 DSP P.C.B.) firmware is displayed.
DSP1 (IC534 DSP P.C.B.) のファームウェアバージョンを表示します。

```
29 ROM VER/SUM
TISUM:0EDAE2AD
```

T11 FLASH SUM (4Byte)

The checksum of DSP1 (IC534 DSP P.C.B.) is displayed.
DSP1 (IC534 DSP P.C.B.) のチェックサムを表示します。

```
29 ROM VER/SUM
XM VER: A007
```

XM VERSION (U, C models)

The version of XM firmware is displayed.
XM のファームウェアバージョンを表示します。

```
29 ROM VER/SUM
SR VER: A001
```

SIRIUS VERSION (U, C models)

The version of SIRIUS firmware is displayed.
SIRIUS のファームウェアバージョンを表示します。

```
29 ROM VER/SUM
N:VER: 10.0
```

Net VERSION (R, T, K, A, B, G, E, L, J models)

The version of NET firmware is displayed.
NET のファームウェアバージョンを表示します。

```
29 ROM VER/SUM
N:SUM: A9D453DA
```

Net SUM (R, T, K, A, B, G, E, L, J models)

The checksum of NET (IC613 NET P.C.B.) is displayed.
NET (IC613 NET P.C.B.) のチェックサムを表示します。

```
29 ROM VER/SUM
T2-VER:02.07r0
```

T12 VERSION

The version of DSP2 (IC567 DSP P.C.B.) firmware is displayed.
DSP2 (IC567 DSP P.C.B.) のファームウェアバージョンを表示します。

29. ROM VER/SUM

プログラムのバージョン、チェックサムを表示します。

信号はエフェクト OFF です。チェックサムは、プログラムエリア別にデータを8ビットごとに加算していき、4桁の16進データで現したものです。

■ AMP ADJUSTMENT / アンプ部調整

Confirmation of Idling Current of Amp Unit

- Right after power is turned on, confirm that the voltage across the terminals of R467 (SURROUND BACK Rch), R468 (SURROUND Rch), R469 (FRONT Rch), R470 (CENTER), R471 (FRONT Lch), R472 (SURROUND Lch), R473 (SURROUND BACK Lch) are between 0.1mV and 10.0mV.
- If it exceeds 10.0mV, open (cut off) R432 (SURROUND BACK Rch), R433 (SURROUND Rch), R434 (FRONT Rch), R435 (CENTER), R436 (FRONT Lch), R437 (SURROUND Lch), R438 (SURROUND BACK Lch) and reconfirm the voltage.

Attention

If the measured voltage exceeds 10.0mV after an amplifier repair, first check for a defective component before cutting the bias resistor.

- Confirm that the voltage is 0.2 mV to 15.0 mV after 60 minutes.

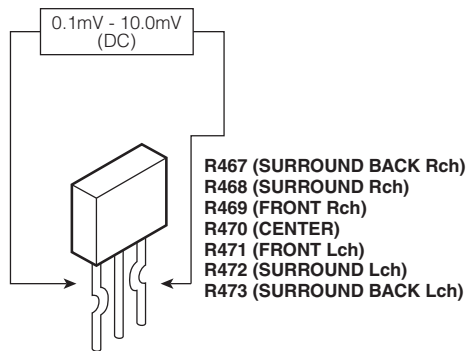

アンプユニットのアイドリング電流の確認

- 電源投入直後、R467 (SURROUND BACK Rch)、R468 (SURROUND Rch)、R469 (FRONT Rch)、R470 (CENTER)、R471 (FRONT Lch)、R472 (SURROUND Lch)、R473 (SURROUND BACK Lch) の端子間電圧を測定し、0.1mV から 10.0mV の間であることを確認してください。
- 電圧が 10mV を超えている場合は、R432 (SURROUND BACK Rch)、R433 (SURROUND Rch)、R434 (FRONT Rch)、R435 (CENTER)、R436 (FRONT Lch)、R437 (SURROUND Lch)、R438 (SURROUND BACK Lch) をカットし、電圧を再確認してください。

注意

パワーアンプ修理後に 10.0mV を超えている場合は、抵抗をカットする前に故障箇所を調べてください。

- 60 分後、電圧が 0.2mV ~ 15.0mV であることを確認してください。

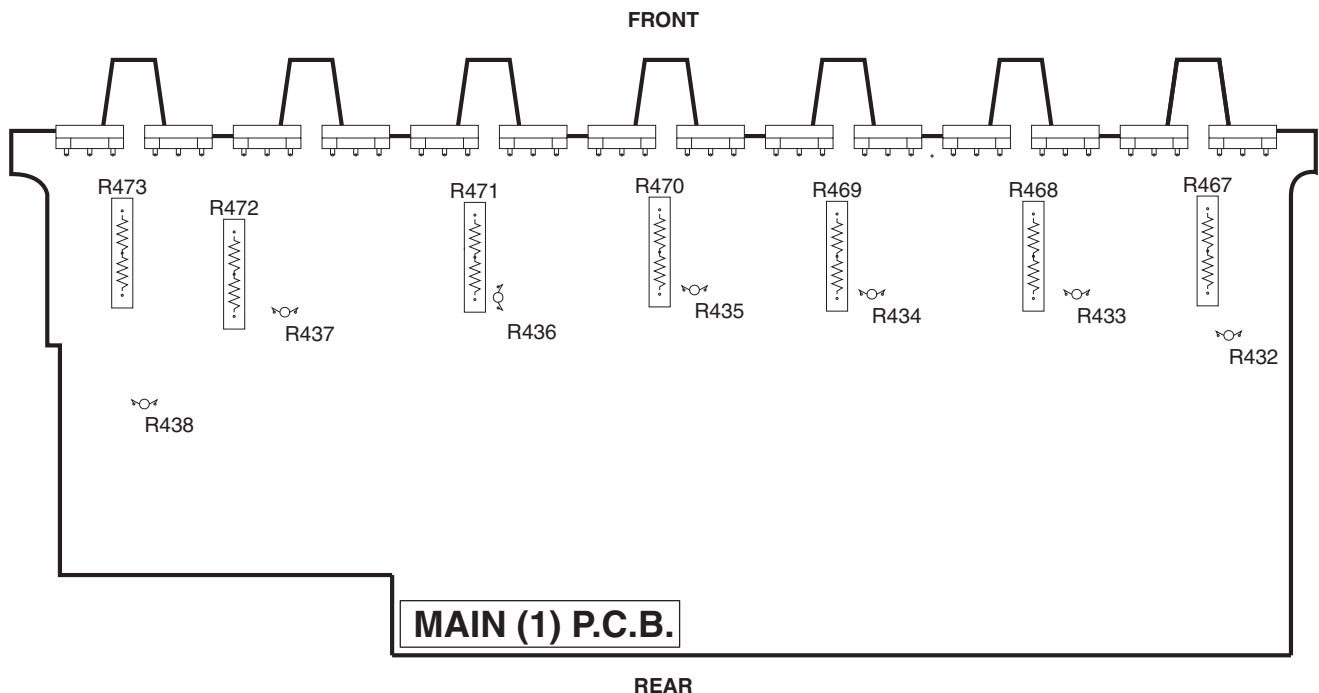
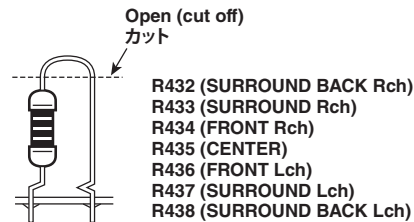

■ DISPLAY DATA

• V9001 : HNA-16ML15T (FL P.C.B.)

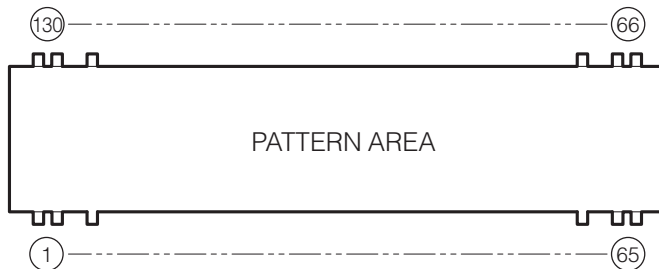

• PIN CONNECTION

Pin No.	130	129	128	127	126	125	124	123	122	121	120	119	118	117	116	115	114	113	112	111	110	109	108	107	106	105	104	103	102	101	100	99	
Connection	F1	F1	NP	NP	P _{35A}	P _{34A}	P _{33A}	P _{32A}	P _{31A}	P _{30A}	P _{29A}	P _{28A}	P _{27A}	P _{26A}	P _{25A}	P _{24A}	P _{23A}	P _{22A}	P _{21A}	P _{20A}	P _{19A}	P _{18A}	P _{17A}	P _{16A}	P _{15A}	P _{14A}	P _{13A}	P _{12A}	P _{11A}	P _{10A}	P _{9A}	P _{8A}	
Pin No.	98	97	96	95	94	93	92	91	90	89	88	87	86	85	84	83	82	81	80	79	78	77	76	75	74	73	72	71	70	69	68	67	66
Connection	P _{7A}	P _{6A}	P _{5A}	P _{4A}	P _{3A}	P _{2A}	P _{1A}	NX(IC)	NX	NX	NX	NX	NX	16GA	15GA	14GA	13GA	12GA	11GA	10GA	9GA	8GA	7GA	6GA	5GA	4GA	3GA	2GA	1GA	NP	NP	F2	F2
Pin No.	34	35	36	37	38	39	40	41	42	43	44	45	46	47	48	49	50	51	52	53	54	55	56	57	58	59	60	61	62	63	64	65	
Connection	P _{8B}	P _{9B}	P _{10B}	P _{11B}	P _{12B}	P _{13B}	P _{14B}	P _{15B}	P _{16B}	P _{17B}	P _{18B}	P _{19B}	P _{20B}	P _{21B}	P _{22B}	P _{23B}	P _{24B}	P _{25B}	P _{26B}	P _{27B}	P _{28B}	P _{29B}	P _{30B}	P _{31B}	P _{32B}	P _{33B}	P _{34B}	P _{35B}	NP	NP	F2	F2	
Pin No.	1	2	3	4	5	6	7	8	9	10	11	12	13	14	15	16	17	18	19	20	21	22	23	24	25	26	27	28	29	30	31	32	33
Connection	F1	F1	NP	NP	1GB	2GB	3GB	4GB	5GB	6GB	7GB	8GB	9GB	10GB	11GB	12GB	13GB	14GB	15GB	NX(IC)	NX	NX	NX	NX	NX	NX	P _{1B}	P _{2B}	P _{3B}	P _{4B}	P _{5B}	P _{6B}	P _{7B}

Note: 1) F1, F2 Filament pin 2) 1GA~16GA, 1GB~15GB Grid pin 3) P1A~P35A, P1B~P35B Anode pin 4) NP No pin 5) NX No extended pin 6) NX(IC) Pins are internally connected, are should be electrically opened on the PCB

• GRID ASSIGNMENT

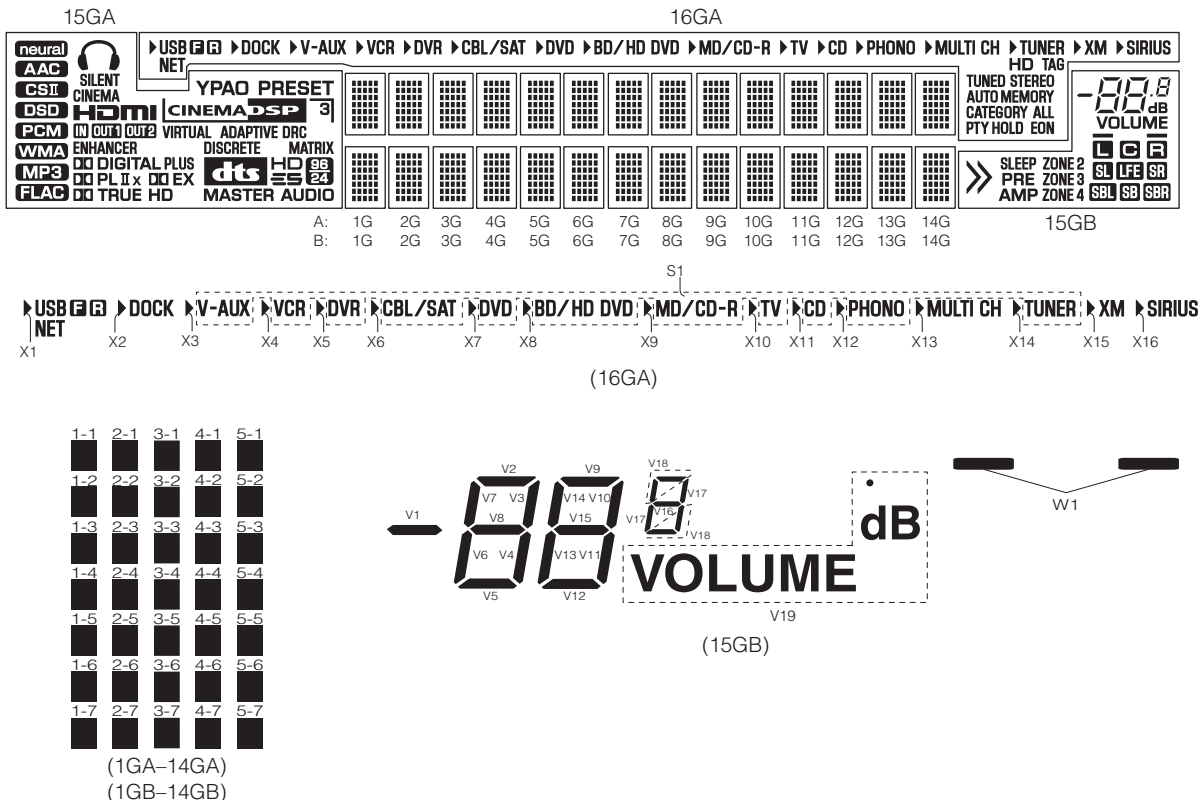

RX-V1900/HTR-6290/DSP-AX1900

• ANODE CONNECTION

	1GA-14GA	15GA	16GA
P1A	1-1A		X1
P2A	2-1A		USB
P3A	3-1A		NET
P4A	4-1A		
P5A	5-1A		XM
P6A	1-2A		X2
P7A	2-2A		DOCK
P8A	3-2A		X3
P9A	4-2A		S1
P10A	5-2A	SILENT CINEMA	X4
P11A	1-3A		X5
P12A	2-3A		X6
P13A	3-3A		X7
P14A	4-3A		X8
P15A	5-3A	ENHANCER	X9
P16A	1-4A	DIGITAL	X10
P17A	2-4A	PLUS	X11
P18A	3-4A	PL	X12
P19A	4-4A	II	X13
P20A	5-4A	x	MULTI CH
P21A	1-5A	EX	X14
P22A	2-5A	TRUE HD	X15
P23A	3-5A	YPAO	SIRIUS
P24A	4-5A	PRESET	X16
P25A	5-5A		HD
P26A	1-6A		TAG
P27A	2-6A	VIRTUAL	TUNED
P28A	3-6A	ADAPTIVE DRC	STEREO
P29A	4-6A	DISCRETE	AUTO
P30A	5-6A	MATRIX	MEMORY
P31A	1-7A		CATEGORY
P32A	2-7A	HD	ALL
P33A	3-7A		PTY
P34A	4-7A		HOLD
P35A	5-7A	MASTER AUDIO	EON

	1GB-14GB	15GB
P1B	1-1B	V1
P2B	2-1B	V2
P3B	3-1B	V3
P4B	4-1B	V4
P5B	5-1B	V5
P6B	1-2B	V6
P7B	2-2B	V7
P8B	3-2B	V8
P9B	4-2B	V9
P10B	5-2B	V10
P11B	1-3B	V11
P12B	2-3B	V12
P13B	3-3B	V13
P14B	4-3B	V14
P15B	5-3B	V15
P16B	1-4B	V16
P17B	2-4B	V17
P18B	3-4B	V18
P19B	4-4B	V19
P20B	5-4B	
P21B	1-5B	SLEEP
P22B	2-5B	PRE AMP
P23B	3-5B	ZONE 2
P24B	4-5B	ZONE 3
P25B	5-5B	ZONE 4
P26B	1-6B	W1
P27B	2-6B	
P28B	3-6B	
P29B	4-6B	
P30B	5-6B	
P31B	1-7B	
P32B	2-7B	
P33B	3-7B	
P34B	4-7B	
P35B	5-7B	

IC DATA

IC182: M30845MW-001-GP (D-VIDEO P.C.B) Video microprocessor

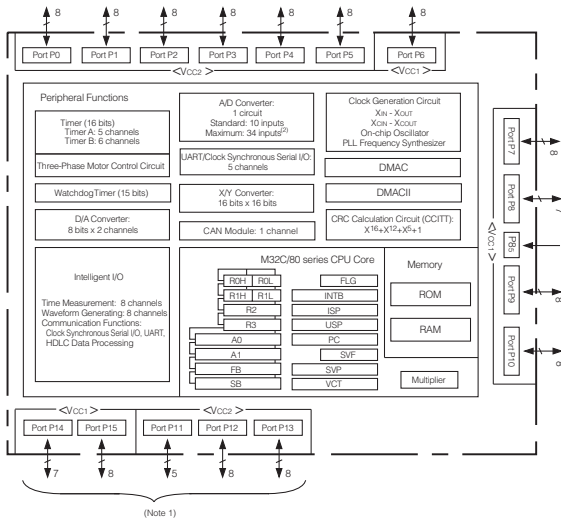

- (Note 1)
- NOTES:
1. Ports P11 to P15 are provided in the 144-pin package only
2. included in the 144-pin package only

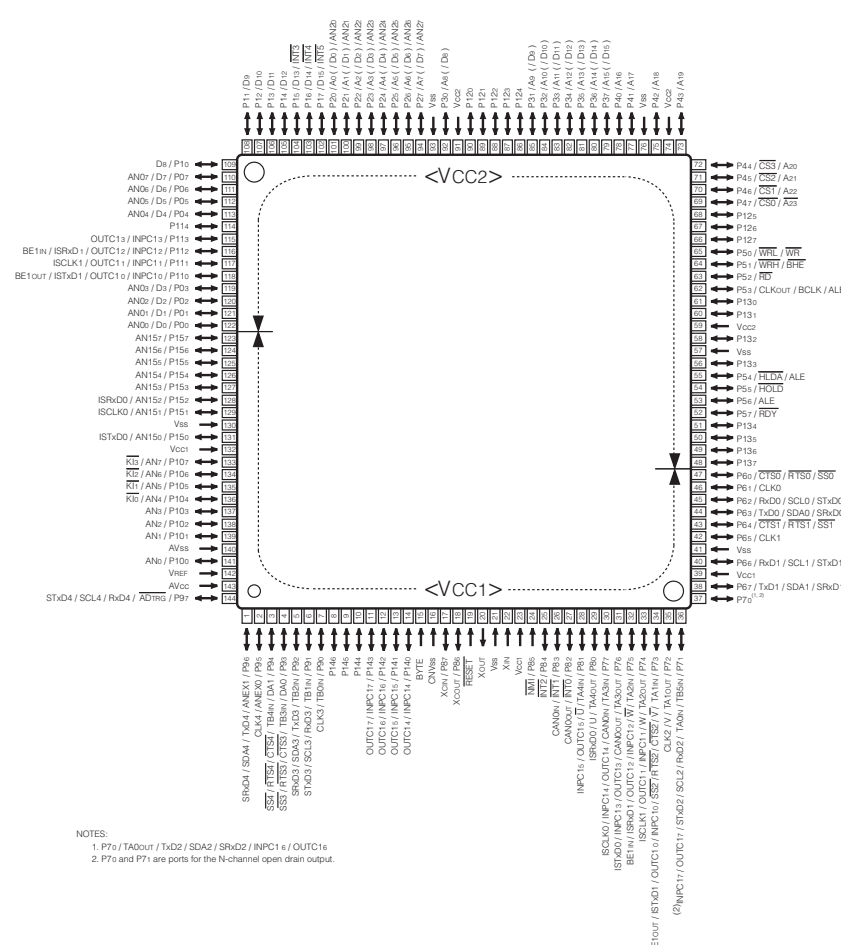

RX-V1900/HTR-6290/DSP-AX1900

RX-V1900/HTR-6290/
DSP-AX1900

No.	Port Name	Function Name	I/O	Detail of Function
1	P96/SDA4	SDAL	SIO	I/O signal of I2C SDA (for 100kHz device)
2	P95/CLK4	NC	O	
3	P94/DA1/TB4in	LPFCTL	O	LPF fs select
4	P93/TB3in	P93	O	YGV VS output, spare
5	P92/SDA3	SDAH	SIO	I/O signal of I2C SDA (for HDMI device)
6	P91/SCL3	SCLH	SO	Output signal of I2C SCL (for HDMI device)
7	P90/TB0in	P90	HiZ	YGV brightness output, spare
8	P146	Test Point	O	Monitor terminal for development
9	P145	Test Point	O	Monitor terminal for development
10	P144/INT6	Test Point	O	Monitor terminal for development
11	P143	HDMI_SELO	O	HDMI_INPUT Select (Bit0)
12	P142	HDMI_SEL1	O	HDMI_INPUT Select (Bit1)
13	P141	HDMI_SEL2	O	HDMI_INPUT Select (Bit2)
14	P140	HDMI_SEL	O	EEPROM (RxINPUT) select
15	BYTE	BYTE	MCU	Data bus width setting: Set to 16bit = LOW
16	CNVSS	CNVSS	MCU	Processor mode: Set to HI
17	P87	NC	O	
18	P86	BOOT (/EN232)	I O	YDC boot signal input 232C line open request (Video -> Main)
19	/RESET	/RES	MCU	Reset signal input
20	XOUT	XOUT	MCU	Ceramic oscillator 10Mhz
21	Vss	GND	MCU	GND
22	XIN	XIN	MCU	Ceramic oscillator 10Mhz
23	Vcc1	5.0V	MCU	5.0V
24	P85/NMI	NMI	I	
25	P84/INT2	/REM	IRQ	Connection to the remote control light receiving section enabled
26	P83/INT1	/INTAD	IRQ	Interrupt signal from ADV7401
27	P82/INT0	/INT Rx	IRQ	HDMI Rx interrupt
28	P81/TA4in	FVS	I	VSYNC frequency measurement, spare
29	P80/TA4out	Test J1-1	I	Start-up option forced log output
30	P77/TA3in	Test J1-2	I	Start-up option HDCP ON/OFF
31	P76/TA3out	Test J1-3	I	Start-up option mobile mode
32	P75/TA2in	HDMINT	O	HDMI interrupt request
33	P74/TA2out	232PWR	I	232C Transceiver shutdown detect input
34	P73/TA1in	/ICEX	O	Reset signal I/O for expander
35	P72/CLK2	MREQ	O	Main microprocessor I/F REQ output signal
36	P71/SCL2	SCLV	SO	Output signal of I2C SCL (for video device)
37	P70/SDA2	SDAV	SIO	I/O signal of I2C SDA (for Video device)
38	P67/TxD1	TXD1	SO	Serial I/F for YDC writing Serial I/F for Debugging/writing
39	Vcc1		MCU	5.0V
40	P66/RxD1	RXD1	SI	Serial I/F for YDC writing Serial I/F for Debugging/writing
41	Vss		MCU	GND
42	P65/CLK1	RTS1	O	Serial I/F for YDC/RS232C writing
43	P64/CTS1	CTS1	I	Serial I/F for YDC/RS232C writing
44	P63/TxD0	VtoM	SO	Main microprocessor I/F SPI
45	P62/RxD0	MtoV	SI	Main microprocessor I/F SPI
46	P61/CLK0	CLKH	SI	Main microprocessor I/F SPI
47	P60/CTS0/RTS0	MRES	O	Main microprocessor I/F RES output signal
48	P137	/RES_Rx	O	Reset HDMI Rx only
49	P136	TMDS_ENB	O	TMDS pull-up ON/OFF (CE of equalizer IC)
50	P135	EDID_ENB	O	Whether accessible to EEPROM or not
51	P134	/AUPS	O	Video passage to HDMI (scaler output) ON/OFF
52	P57/RDY	/RDY	I	YVG/WAIT signal input
53	P56/ALE/RAS	NC	O	
54	P55/HOLD	NC	I	
55	P54/HLDA/ALE	NC	O	
56	P133	PSENB	O	HDMI Tx power signal enable
57	Vss	GND	MCU	GND
58	P132	DDCENB	O	HDMI DDC enable control
59	Vcc2	3.3V	MCU	3.3V
60	P131	AUPAUD	O	Audio passage to HDMI, output select

No.	Port Name	Function Name	I/O	Detail of Function
61	P130	HPDENB	O	Whether to return HPD to Source or not
62	P53/BCLK	DON'T USE	O	L output fixed
63	P52/RD/DW	/RD	BUS	BUS I/F
64	P51/WRH/BHE	/WRH	BUS	BUS I/F
65	P50/WRL/WR	/WRL	BUS	BUS I/F
66	P127	/IPSS	O	IP00C772 I/F
67	P126	IPSCLK	O	IP00C772 I/F
68	P125	IPSI	SO	IP00C772 I/F
69	P47/CS0/A23	/A23	BUS	
70	P46/CS1/A22	A22	BUS	
71	P45/CS2/A21	A21	BUS	FLASH A20/NC2, YGV A21
72	P44/CS3/A20	A20	BUS	FLASH A19/NC1, YGV A20
73	P43/A19	A19	BUS	FLASH A18, YGV A19
74	Vcc2	3.3V	MCU	3.3V
75	P42/A18	A18	BUS	FLASH A17, YGV A18
76	Vss	GND	MCU	GND
77	P41/A17	A17	BUS	FLASH A16, YGV A17
78	P40/A16	A16	BUS	FLASH A15, YGV A16
79	P37/A15	A15	BUS	FLASH A14, YGV A15
80	P36/A14	A14	BUS	FLASH A13, YGV A14
81	P35/A13	A13	BUS	FLASH A12, YGV A13
82	P34/A12	A12	BUS	FLASH A11, YGV A12
83	P33/A11	A11	BUS	FLASH A10, YGV A11
84	P32/A10	A10	BUS	FLASH A9, YGV A10
85	P31/A9	A9	BUS	FLASH A8, YGV A9
86	P124	/RES_Tx	O	Reset HDMI Tx only
87	P123	IPSO	SI	IP00C772 I/F
88	P122	NC	O	
89	P121	/AUPEC	O	Video passage to HDMI (DECODER output) ON/OFF
90	P120	/AUIPC	O	Video passage to HDMI (IP conversion output) ON/OFF
91	Vcc2	3.3V	MCU	3.3V
92	P30/A8	A8	BUS	FLASH A7, YGV A8
93	Vss	GND	MCU	GND
94	P27/A7	A7	BUS	FLASH A6, YGV A7
95	P26/A6	A6	BUS	FLASH A5, YGV A6
96	P25/A5	A5	BUS	FLASH A4, YGV A5
97	P24/A4	A4	BUS	FLASH A3, YGV A4
98	P23/A3	A3	BUS	FLASH A2, YGV A4
99	P22/A2	A2	BUS	FLASH A1, YGV A2
100	P21/A1	A1	BUS	FLASH A0, YGV A1
101	P20/A0	A0	BUS	
102	P17/D15/INT5	D15	BUS	Data bus
103	P16/D14/INT4	D14	BUS	Data bus
104	P15/D13/INT3	D13	BUS	Data bus
105	P14/D12	D12	BUS	Data bus
106	P13/D11	D11	BUS	Data bus
107	P12/D10	D10	BUS	Data bus
108	P11/D9	D9	BUS	Data bus
109	P10/D8	D8	BUS	Data bus
110	P07/D7	D7	BUS	Data bus
111	P06/D6	D6	BUS	Data bus
112	P05/D5	D5	BUS	Data bus
113	P04/D4	D4	BUS	Data bus
114	P114	/ICS	O	/IC signal to ABT1010. Cancelled after clock supply
115	P113	/AUPYGV	O	Video passage to HDMI (YGV619 output) ON/OFF
116	P112	/ICIP	O	/IC signal to YGV619
117	P111	/ICY	O	/IC signal to YGV619
118	P110	/ICV	O	/IC signal to VDEC
119	P03/D3	D3	BUS	Data bus
120	P02/D2	D2	BUS	Data bus
121	P01/D1	D1	BUS	Data bus
122	P00/D0	D0	BUS	Data bus
123	P157	VTEST1	O	Output of self-check result, for product testing (Video)

RX-V1900/HTR-6290/DSP-AX1900

RX-V1900/HTR-6290/
DSP-AX1900

No.	Port Name	Function Name	I/O	Detail of Function
124	P156	VTEST2	O	Output of self-check result, for product testing (Video)
125	P155	NC	O	
126	P154	/OSDCEV	O	Chip enable output to OSD (for CUI)
127	P153	NC	O	
128	P152	CSS	O	Chip enable output of LC709004A
129	P151	SDTV	O	Also used as Data *OSD (for CUI) to control LC709004A
130	Vss	GND	MCU	GND
131	P150	SCKV	O	Also used as Clock *OSD (for CUI) to control LC709004A
132	Vcc1	5.0V	MCU	5.0V
133	P107/AN7	/MTMON	O	Mute signal from Video microprocessor to monitor OUT
134	P106/AN6	/MTZ2	O	Mute signal from Video microprocessor to ZONE 2 OUT
135	P105/AN5	Reserve	O	
136	P104/AN4	SVDET	I	S input detect
137	P103/AN3	VBOOT	I	Boot mode enable
138	P102/AN2	BTSEL	I	Boot mode select
139	P101/AN1	Reserve	O	
140	Avss	GND	MCU	GND
141	P100/AN0	SENS	AD	Sensor input for Auto Lip Sinc
142	Vref	5.0V	MCU	5.0V
143	Avcc	5.0V	MCU	5.0V
144	P97/SCL4	SCLL	SO	Output signal of I2C SCL (for 100kHz device)

IC402: M3087BFKBGP (FUNCTION P.C.B)
Main microprocessor

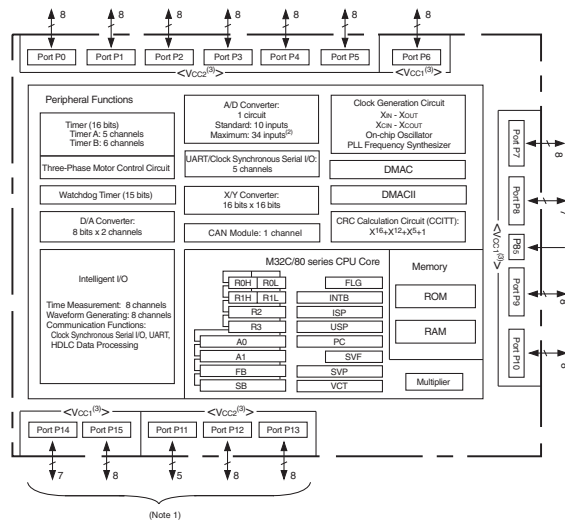

- NOTES:
1. Ports P11 to P15 are provided in the 144-pin package only.
 2. Included in the 144-pin package only.
 3. The supply voltage of M32C84T (High-reliability version) must be VCC1=VCC2.

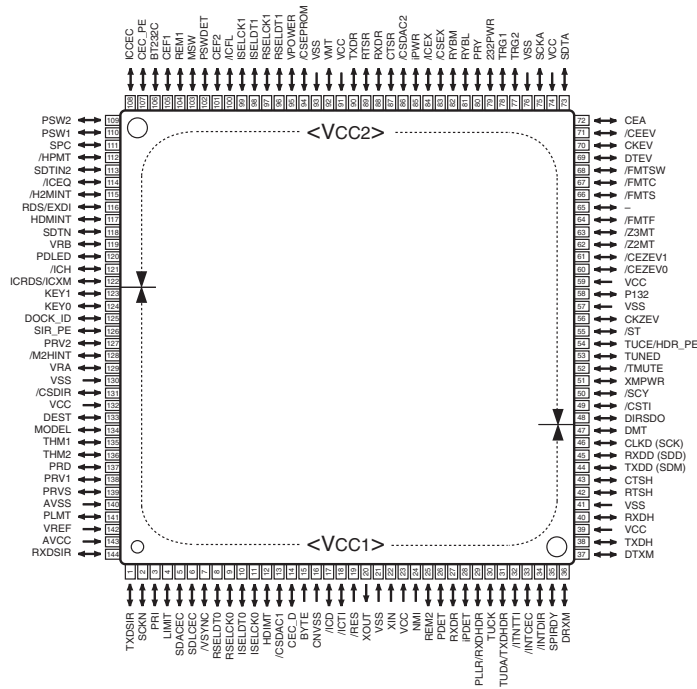

- NOTES:
1. P70 / TA0out / TxD2 / SDA2 / SFRXD2 / INPC16 / OUTC16
 2. P70 and P71 are ports for the N-channel open drain output.
 3. The supply voltage of M32C84T must be VCC1=VCC2.

RX-V1900/HTR-6290/
DSP-AX1900

No.	Port Name	Function Name (P.C.B.)	I/O	Detail of Function
1	TXDSIR	TXDH	SO	Data transmission to VIDEO_CPU
2	SCKN	CLKH	SO	Clock transmission to VIDEO_CPU
3	PRI	LIMIT	DA	Limiter control output
4	LIMIT	HDMINT	TMR	HDMI MUTE input
5	SDACEC	TXDi	SO	iPod asynchronous serial data input
6	SDLCEC	RXDi	SI	iPod asynchronous serial data output
7	/VSYNC	/VSYNC	TMR	Vertical sync pulse INT
8	RSELDT0	RSELDT0	O	Rec out SW1 control (ROHM) data (U, C, R, T, A, B, G, E, L models)
9	RSELCK0	RSELCK0	O	Rec out SW1 control (ROHM) clock (U, C, R, T, A, B, G, E, L models)
10	ISELDT0	ISELDT0	O	Rec out SW1 control (ROHM) data
11	ISELCK0	ISELCK0	O	Rec out SW1 control (ROHM) clock
12	HDIMT	/CSDAC2	O	TI#1 initial clear
13	/CSDAC1	/CSDAC1	O	2sh DAC (PCM1791A) *6 chip enable
14	CEC_D	/CSY	O	TI#1 chip enable
15	BYTE	BYTE	MCU	External data bus width change: 16bit
16	CNVSS	CNVSS	MCU	Processor mode select: Single chip mode
17	/ICD	/ICD	O	DIR initial clear
18	/ICTI	/ICTI	I	TI#1 SPI READY
19	/RES	/RES	MCU	
20	XOUT	XOUT	MCU	
21	VSS	VSS	MCU	
22	XIN	XIN	MCU	
23	VCC	VCC	MCU	
24	NMI	NMI	IRQ	
25	REM2	REM1	IRQ	Remote control pulse input 1
26	PDET	PDET	IRQ	Power detect
27	RXDR	RXDR	IRQ	RS232C · YDC signal reception detect
28	iPDET	iPDET	TMR	iPod detect
29	PLL/RXDHDR	/CSTI	O	TI#0 (IC534 DSP P.C.B.) chip enable
30	TUCK	/ICXM	O	DABIC IC reset (U model)
		(RDSCE)	O	RDS enable (G model)
31	TUDA/TXDHDR	XMPWR	O	XM Radio power control (U, C models)
32	/ITNTTI	/ITNTI	TMR	TI#0/#1 (DA70Y) interrupt
33	/INTCEC	/CSSIR	O	DIR chip enable
34	/INTDIR	/INTDIR	TMR	DIR interrupt
35	SPIRDY	/SPIRDY	I	TI DA70Y serial ready / DIR WCK input (WCK input for CDDA writing)
36	DRXM	DRXM	SI	DABIC IC RxD (XM data reception) (U, C models)
37	DTXM	DTXM	SO	DABIC IC TxD (U, C models)
38	TXDH	TXDR	SO	Usually RS-232C asynchronous communication data output / Data transmission terminal for AF220
39	VCC	VCC	MCU	
40	RXDH	RXDR	SI	Usually RS-232C asynchronous communication data input / Data reception terminal for AF220
41	VSS	VSS	MCU	
42	RTSH	RTS	SO	Usually RS-232C asynchronous RTS output
43	CTSH	CTS	I	Usually RS-232C asynchronous CTS input
44	TXDD (SDM)	TXDD (SDM)	SO	Serial data output to DIR, TI, DAC
45	RXDD (SDD)	RXDD (SDD)	SI	Serial data reception to DIR, TI, DAC
46	CLKD (SCK)	CLKD (SCK)	SO	Serial clock output to DIR, TI, DAC
47	DMT	DMT	O	Digital full mute (Hi=Mute)
48	DIRSDO	DIRSDO	I	Usable for both CDDA write data input/XM LINK ACTIVE
49	/CSTI	TUDA	O	PLL data output for tuner
50	/SCY	TUCK	O	PLL clock output for tuner
51	XMPWR	PLL	I	PLL reception for tuner
52	/TMUTE	/TMUTE	O	TUNER mute output
53	TUNED	TUNED	I	TUNER TUNED input
54	TUCE/HDR_PE	TUCE	O	PLL chip select for TUNER
55	/ST	/ST	I	TUNER STEREO detect input
56	CKZEV	CKZEV	O	ZONE tone control IC serial transmission clock (U, C, R, T, K, A, B, G, E, L models)
57	VSS	VSS	MCU	

No.	Port Name	Function Name (P.C.B.)	I/O	Detail of Function
58	DTZEV	DTZEV	O	ZONE tone control IC serial transmission data (U, C, R, T, K, A, B, G, E, L models)
59	VCC	VCC	MCU	
60	/CEZEV0	/CEZEV0	O	ZONE tone control chip selector (U, C, R, T, K, A, B, G, E, L models)
61	/CEZEV1	/CEZEV1	O	
62	/Z2MT	/Z2MT	O	Zone2 mute control (U, C, R, T, K, A, B, G, E, L models)
63	/Z3MT	/Z3MT	O	Zone3 mute control (U, C, R, T, K, A, B, G, E, L models)
64	/FMTF	/FMTF	O	Full mute FL/FR/SBL/SBR
65	-	-	O	
66	/FMST	/FMST	O	Full mute SL/SR
67	/FMTC	/FMTC	O	Full mute Center
68	/FMSTW	/FMSTW	O	Full mute SWL/SWR/SW MONO
69	DTEV	DTEV	O	E-VOLUME IC serial transmission data for MAIN ZONE (U, C, R, T, K, A, G, B, E, L models)
70	CKEV	CKEV	O	E-VOLUME IC serial transmission clock for MAIN ZONE (U, C, R, T, K, A, G, B, E, L models)
71	/CEEV	/CEEV	O	E-VOLUME CE for MAIN, ZONE (U, C, R, T, K, A, G, B, E, L models)
72	CEA	CEA	O	Chip select output for JRC audio select IC
73	SDTA	SDTA	O	Data output for JRC audio select IC
74	VCC	VCC	MCU	
75	SCKA	SCKA	O	Clock output for JRC audio select IC
76	VSS	VSS	MCU	
77	TRG2	TRG2	O	DC trigger output2 (U, C, R, T, K, A, B, G, E, L models)
78	TRG1	TRG1	O	DC trigger output1 (U, C, R, T, K, A, B, G, E, L models)
79	232PWR	232PWR	O	RS232C driver ON/OFF control
80	PRY	PRY	O	Power relay control
81	RYBL	RYBL	O	Relay control for power control of power amplifier B
82	RYBM	RYBM	O	Relay control for power control of power amplifier B
83	/CSEX	/CSEX	O	Chip select for extension IC
84	/ICEX	/ICEX	O	Reset for extension IC
85	iPWR	iPWR	O	iPod power control
86	/CSDAC2	VPOWER	O	VIDEO power control
87	CTSR	PRI	I	Electric current protection detect
88	RXDR	SDTN	O	FL driver/OSD/ data output for extension IC/data output for RDS IC (G model)
89	RTSR	SCKN	O	FL driver/OSD/ data output for extension IC/data output for RDS IC (G model)
90	TXDR	RDS/EXDI	I	Data in for extension IC
91	VCC	VCC	MCU	
92	VMT	VMT	O	Video output mute
93	VSS	VSS	MCU	
94	/CSEEPROM	/OSDCE	O	OSD CE
95	VPOWER	iPAP	I	iPod accessory power detect
96	RSELDT1	RSELDT1	O	Rec out SW1 control (ROHM) data (U, C, R, T, K, A, B, G, E, L models)
97	RSELCK1	RSELCK1	O	Rec out SW1 control (ROHM) clock
98	ISELDT1	ISELDT1	O	Rec out SW1 control (ROHM) data, clock speed: 20us
99	ISELCK1	ISELCK1	O	Rec out SW1 control (ROHM) clock
100	/ICFL	/ICFL	O	FL driver initial clear
101	CEF2	CEF2	O	FL enable2
102	PSWDET	PSWDET	IRQ	Main, Zone2, 3 power key interrupt
103	MSW	MSW	IRQ	Master SW (push lock SW)
104	REM1	REM2	IRQ	Remote control pulse input 2, remote control pulse input for Zone (U, C, R, T, K, A, B, G, E, L models)
105	CEF1	CEF1	O	FL enable1
106	BT232C	BT232C	I	RS232C Flash write mode detect
107	CEC_PE	ISA	I	Input selector rotary A
108	ICCEC	ISB	I	Input selector rotary B
109	PSW2	PSW2	I	INT5: PSW input after logic Key identification
110	PSW1	PSW1	I	INT5: PSW input after logic Key identification
111	SPC	SPC	O	+5SPC power ON/OFF control (L-ON/H-OFF: to reduce stand-by power)
112	/HPMT	/HPMT	O	Headphone mute control
113	SDTIN2	PGA	I	Program rotary A

RX-V1900/HTR-6290/DSP-AX1900

RX-V1900/HTR-6290/
DSP-AX1900

No.	Port Name	Function Name (P.C.B.)	I/O	Detail of Function
114	/ICEQ	PGB	I	Program rotary B
115	/H2MINT	VRA	I	Volume rotary A
116	RDS/EXDI	RXDNW	SI	Asynchronous data input for NETWORK MODULE
117	HDMINT	NWRST	O	Reset output for NETWORK MODULE
118	SDTN	TXDNW	SO	Asynchronous data output for NETWORK MODULE
119	VRB	VRB	I	Volume rotary B
120	PDLED	PDLED	O	Pure direct LED
121	/ICH	RDDATA	I	RDS RxD (B, G models)
122	ICRDS/ICXM	HDIMT	I	HDMI mute input
123	KEY1	KEY1	AD	KEY 1 AD value taken in
124	KEY0	KEY0	AD	KEY 0 AD value taken in
125	DOCK_ID	VBOOT	O	VIDEO_CPU boot enable
126	SIR_PE	BTSEL	O	VIDEO_CPU boot mode select
127	PRV2	/EN232C	I	VIDEO_CPU 232C communication line enable control detect
128	/M2HINT	HRES	I	VIDEO_CPU response return input
129	VRA	HREQ	TMR	VIDEO_CPU transfer request input
130	VSS	VSS	MCU	
131	/CSDIR	/ICH	O	VIDEO_CPU reset
132	VCC	VCC	MCU	
133	DEST	DEST	AD	Destination identification by AD value
134	MODEL	MODEL	AD	Model identification by AD value
135	THM1	THM1	AD	AD temperature detect 1
136	THM2	THM2	AD	AD temperature detect 2
137	PRD	PRD	AD	Power amplifier DC protect detect
138	PRV1	PRV	AD	Power protection detect 1
139	PRVS	PRVS	AD	Power protection detect 2 (power turned OFF by pure direct)
140	AVSS	AVSS	MCU	
141	PLMT	PLMT	AD	AD power limiter output level detect
142	VREF	VREF	MCU	
143	AVCC	AVCC	MCU	
144	RXDSIR	RXDH	SI	Data reception from VIDEO_CPU

RX-V1900 (U, C, R, T, K, A, B, G, E, L models) / HTR-6290 (C, G models)

Key input(A-D) pull-up resistance 10 k-ohms

Ohm	0	+1.2k	+1.2k	+1.8k	+2.7k	+3.3k	+4.7k	+8.2k	+18.0k	+47.0k
V	-0.26	-0.75	-1.22	-1.76	-2.28	-2.75	-3.24	-3.75	-4.25	-4.72
Key0 (124pin/AN156)	INFO	ZONE CONTROLS	CATEGORY/BAND	STEREO/MONO	SEARCH MODE	MEMORY	PRESET/TUNING >	PRESET/TUNING <	-	-
Key1 (123pin/AN157)	STRAIGHT / EFFECT	ENTER	-	TONE CONTROL	AUDIO SELECT	PURE DIRECT	-	-	-	-

DSP-AX1900 (J model)

Key input(A-D) pull-up resistance 10 k-ohms

Ohm	0	+1.2k	+1.2k	+1.8k	+2.7k	+3.3k	+4.7k	+8.2k	+18.0k	+47.0k
V	-0.26	-0.75	-1.22	-1.76	-2.28	-2.75	-3.24	-3.75	-4.25	-4.72
Key0 (124pin/AN156)	INFO	-	BAND	STEREO/MONO	SEARCH MODE	MEMORY	PRESET/TUNING >	PRESET/TUNING <	-	-
Key1 (123pin/AN157)	STRAIGHT / EFFECT	ENTER	-	TONE CONTROL	AUDIO SELECT	PURE DIRECT	-	-	-	-

Destination for AD Port / 仕向け先判別ポート

Pull-up resistance 10 k-ohms

Ohm	0.0k	1.2k	2.7k	4.7k	6.8k	10.0k	15.0k	24.0k	47.0k	100.0k
V	0-0.2	0.3-0.8	0.9-1.3	1.4-1.8	1.8-2.2	2.3-2.7	2.8-3.2	3.3-3.8	3.9-4.3	4.4-4.7
A-D (5V=255)	0-13	14-40	41-68	69-92	93-115	116-140	141-167	168-195	196-221	222-243
DEST (AN7) 133pin	J	U, C	-	R	T	K	A	-	B, G, E	L

Model distinction for AD port / モデル判別ポート

Ohm	47k	∞
V	1.3-3.7	3.8-5.0
A-D (5V=255)	65-191	192-255
DEST (AN6) 134pin	RX-V1900/DSP-AX1900	HTR-6290

IC534, 567: D70YE101BRFP266 (DSP P.C.B.)

Decoder/Post processor

* No replacement part available. / サービス部品供給なし

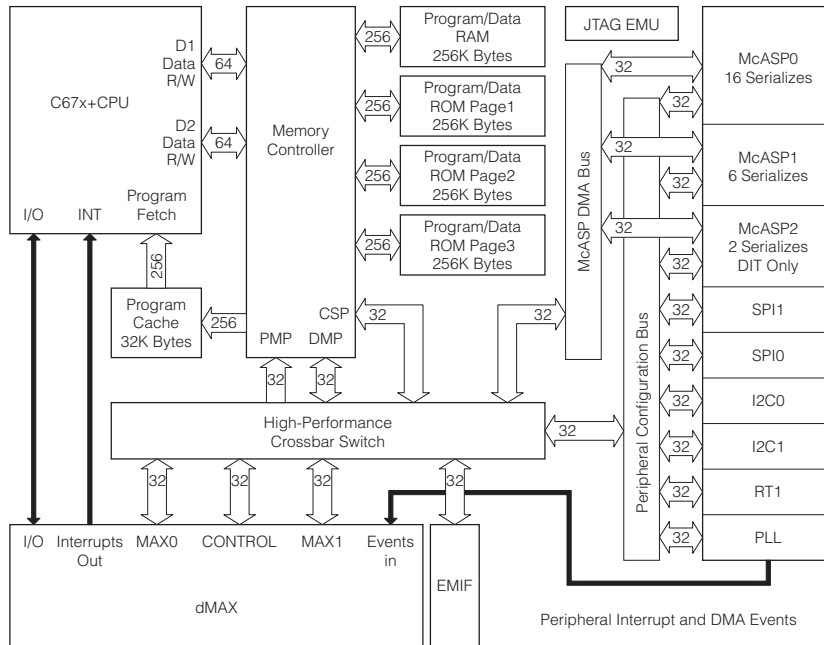
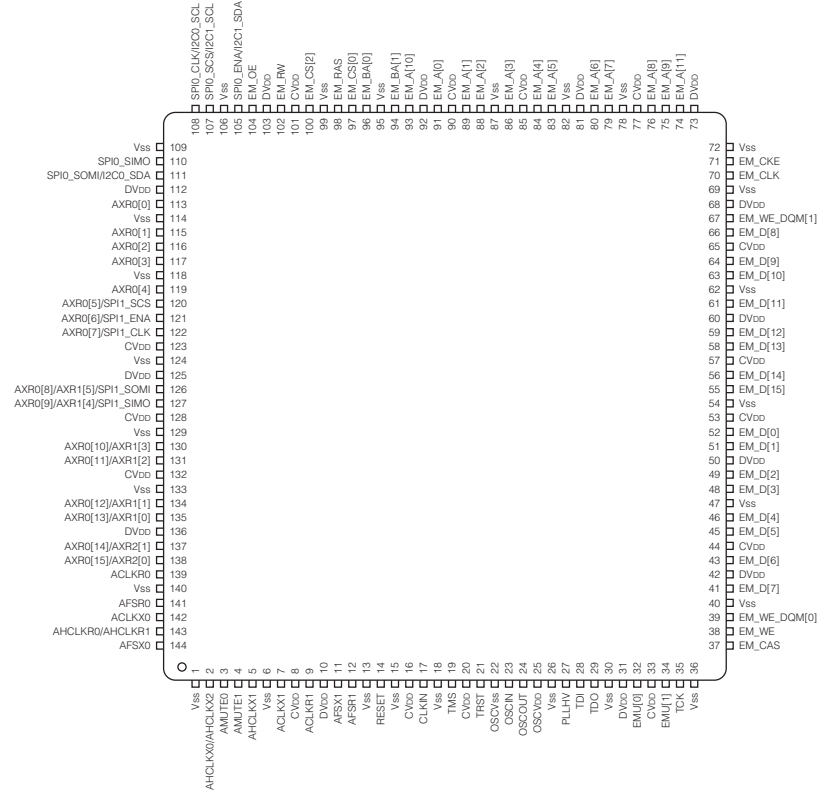

RX-V1900/HTR-6290/
DSP-AX1900

No.	Function Name	TYPE ⁽¹⁾	PULL ⁽²⁾	GPIO ⁽³⁾	Detail of Function
1	Ground(Vss)				
2	AHCLKX0/AHCLKX2	IO	–	Y	McASP0 and McASP2 transmit master clock
3	AMUTE0	IO	–	Y	McASP0 mute output
4	AMUTE1	IO	–	Y	McASP1 mute output
5	AHCLKX1	IO	–	Y	McASP1 transmit master clock
6	Ground(Vss)				
7	ACLKX1	IO	–	Y	McASP1 transmit bit clock
8	Core Supply (CVpp)				
9	ACLKR1	IO	–	Y	McASP1 receive bit clock
10	IO Supply (DVpp)				
11	AFSX1	IO	–	Y	McASP1 transmit frame Sync (L/R clock)
12	AFSR1	IO	–	Y	McASP1 receive frame Sync (L/R clock)
13	Ground(Vss)				
14	RESET	IO	–	N	Device reset pin
15	Ground(Vss)				
16	Core Supply (CVpp)				
17	CLKIN	IO	–	N	Alternate clock input (3.3-V LVCMOS input)
18	Ground(Vss)				
19	TMS	IO	IPU	N	Test mode select
20	Core Supply (CVpp)				
21	TRST	IO	IPU	N	Test reset
22	OSCVss	PWR	–	N	Oscillator Vss tap point (for filter only)
23	OSCIN	IO	–	N	1.2-V oscillator input
24	OSCOUT	O	–	N	1.2-V oscillator output
25	OSCVpp	PWR	–	N	Oscillator 1.2-V Vpp tap point (for filter only)
26	Ground(Vss)				
27	PLLHV	PWR	–	N	PLL 3.3-V supply input (requires external filter)
28	TDI	IO	IPU	N	Test data in
29	TDO	OZ	IPU	N	Test data out
30	Ground(Vss)				
31	IO Supply (DVpp)				
32	EMU[0]	IO	IPU	N	Emulation pin 0
33	Core Supply (CVpp)				
34	EMU[1]	IO	IPU	N	Emulation pin 1
35	TCK	IO	IPU	N	Test clock
36	Ground(Vss)				
37	EM_CAS	O	–	N	SDRAM column address strobe
38	EM_WE	O	–	N	SDRAM write enable
39	EM_WE_DQM[0]	O	–	N	Write enable or byte enable for EM_D [7:0]
40	Ground(Vss)				
41	EM_D[7]	IO	–	N	EMIF data bus [lower 16-bits]
42	IO Supply (DVpp)				
43	EM_D[6]	IO	–	N	EMIF data bus [lower 16-bits]
44	Core Supply (CVpp)				
45	EM_D[5]	IO	–	N	EMIF data bus [lower 16-bits]
46	EM_D[4]	IO	–	N	EMIF data bus [lower 16-bits]
47	Ground(Vss)				
48	EM_D[3]	IO	–	N	EMIF data bus [lower 16-bits]
49	EM_D[2]	IO	–	N	EMIF data bus [lower 16-bits]
50	IO Supply (DVpp)				
51	EM_D[1]	IO	–	N	EMIF data bus [lower 16-bits]
52	EM_D[0]	IO	–	N	EMIF data bus [lower 16-bits]
53	Core Supply (CVpp)				
54	Ground(Vss)				
55	EM_D[15]	IO	–	N	EMIF data bus [lower 16-bits]
56	EM_D[14]	IO	–	N	EMIF data bus [lower 16-Bits]
57	Core Supply (CVpp)				
58	EM_D[13]	IO	–	N	EMIF data bus [lower 16-Bits]
59	EM_D[12]	IO	–	N	EMIF data bus [lower 16-Bits]
60	IO Supply (DVpp)				
61	EM_D[11]	IO	–	N	EMIF data bus [lower 16-Bits]
62	Ground(Vss)				
63	EM_D[10]	IO	–	N	EMIF data bus [lower 16-Bits]

No.	Function Name	TYPE ⁽¹⁾	PULL ⁽²⁾	GPIO ⁽³⁾	Detail of Function
64	EM_D[9]	IO	-	N	EMIF data bus [lower 16-Bits]
65	Core Supply (C/Vpp)				
66	EM_D[8]	IO	-	N	EMIF data bus [lower 16-bits]
67	EM_WE_DQM[1]	O	-	N	Write enable or byte enable for EM_D [15:8]
68	IO Supply (D/Vpp)				
69	Ground(Vss)				
70	EM_CLK	O	-	N	SDRAM clock
71	EM_CKE	O	-	N	SDRAM clock enable
72	Ground(Vss)				
73	IO Supply (D/Vpp)				
74	EM_A[11]	O	-	N	EMIF address bus
75	EM_A[9]	O	-	N	EMIF address bus
76	EM_A[8]	O	-	N	EMIF address bus
77	Core Supply (C/Vpp)				
78	Ground(Vss)				
79	EM_A[7]	O	-	N	EMIF address bus
80	EM_A[6]	O	-	N	EMIF address bus
81	IO Supply (D/Vpp)				
82	Ground(Vss)				
83	EM_A[5]	O	-	N	EMIF address bus
84	EM_A[4]	O	-	N	EMIF address bus
85	Core Supply (C/Vpp)				
86	EM_A[3]	O	-	N	EMIF address bus
87	Ground(Vss)				
88	EM_A[2]	O	-	N	EMIF address bus
89	EM_A[1]	O	-	N	EMIF address bus
90	Core Supply (C/Vpp)				
91	EM_A[0]	O	-	N	EMIF address bus
92	IO Supply (D/Vpp)				
93	EM_A[10]	O	-	N	EMIF address bus
94	EM_BA[1]	O	-	N	SDRAM bank address and asynchronous memory Low-Order address
95	Ground(Vss)				
96	EM_BA[0]	O	-	N	SDRAM bank address and asynchronous memory Low-Order address
97	EM_CS[0]	O	-	N	SDRAM chip select
98	EM_RAS	O	-	N	SDRAM row address strobe
99	Ground(Vss)				
100	EM_CS[2]	O	-	N	Asynchronous memory chip select
101	Core Supply (C/Vpp)				
102	EM_RW	O	-	N	Asynchronous memory read/ndt write
103	IO Supply (D/Vpp)				
104	EM_OE	O	-	N	SDRAM output enable
105	SPI0_ENA/I2C1_SDA	IO	-	Y	SPI0 enable (ready) or I2C1 serial data
106	Ground(Vss)				
107	SPI0_ENA/I2C1_SCL	IO	-	Y	SPI0 enable (ready) or I2C1 serial clock
108	SPI0_CLK/I2C0_SCL	IO	-	Y	SPI0 serial clock or I2C0 serial clock
109	Ground(Vss)				
110	SPI0_SIMO	IO	-	Y	SPI0 data pin slave in master out
111	SPI0_SOMI/I2C0_SDA	IO	-	Y	SPI0 data pin slave out master in or I2C0 serial data
112	IO Supply (D/Vpp)				
113	AXRQ[0]	IO	-	Y	McASP0 serial data 0
114	Ground(Vss)				
115	AXRQ[1]	IO	-	Y	McASP0 serial data 1
116	AXRQ[2]	IO	-	Y	McASP0 serial data 2
117	AXRQ[3]	IO	-	Y	McASP0 serial data 3
118	Ground(Vss)				
119	AXRQ[4]	IO	-	Y	McASP0 serial data 4
120	AXRQ[5]/SPI1_SCS	IO	-	Y	McASP0 serial data 5 or SPI1 slave chip select
121	AXRQ[6]/SPI1_ENA	IO	-	Y	McASP0 serial data 6 or SPI1 enable (ready)
122	AXRQ[7]/SPI1_CLK	IO	-	Y	McASP0 serial data 7 or SPI1 serial clock
123	Core Supply (C/Vpp)				
124	Ground(Vss)				

No.	Function Name	TYPE ⁽¹⁾	PULL ⁽²⁾	GPIO ⁽³⁾	Detail of Function
125	IO Supply (D/Vpp)				
126	AXRQ[8]/AXR1[5]/SPI1_SOMI	IO	-	Y	McASP0 serial data 8 or McASP1 serial data 5 or SPI1 data pin slave out master in
127	AXRQ[9]/AXR1[4]/SPI1_SIMO	IO	-	Y	McASP0 serial data 9 or McASP1 serial data 4 or SPI1 data pin slave in master out
128	Core Supply (C/Vpp)				
129	Ground(Vss)				
130	AXRQ[10]/AXR1[3]	IO	-	Y	McASP0 serial data 10 or McASP1 serial data 3
131	AXRQ[11]/AXR1[2]	IO	-	Y	McASP0 serial data 11 or McASP1 serial data 2
132	Core Supply (C/Vpp)				
133	Ground(Vss)				
134	AXRQ[12]/AXR1[1]	IO	-	Y	McASP0 serial data 12 or McASP1 serial data 1
135	AXRQ[13]/AXR1[0]	IO	-	Y	McASP0 serial data 13 or McASP1 serial data 0
136	IO Supply (D/Vpp)				
137	AXRQ[14]/AXR2[1]	IO	-	Y	McASP0 serial data 14 or McASP2 serial data 1
138	AXRQ[15]/AXR2[0]	IO	-	Y	McASP0 serial data 15 or McASP2 serial data 0
139	ACLKRO	IO	-	Y	McASP0 receive bit clock
140	Ground(Vss)				
141	AFSR0	IO	-	Y	McASP0 receive frame Sync (L/R clock)
142	ACLKX0	IO	-	Y	McASP0 transmit bit clock
143	AHCLKR0/AHCLKR1	IO	-	Y	McASP0 and McASP1 receive master clock
144	AF-SX0	IO	-	Y	McASP0 transmit frame Sync (L/R clock)

BLOCK DIAGRAMS

AUDIO SECTION BLOCK DIAGRAM

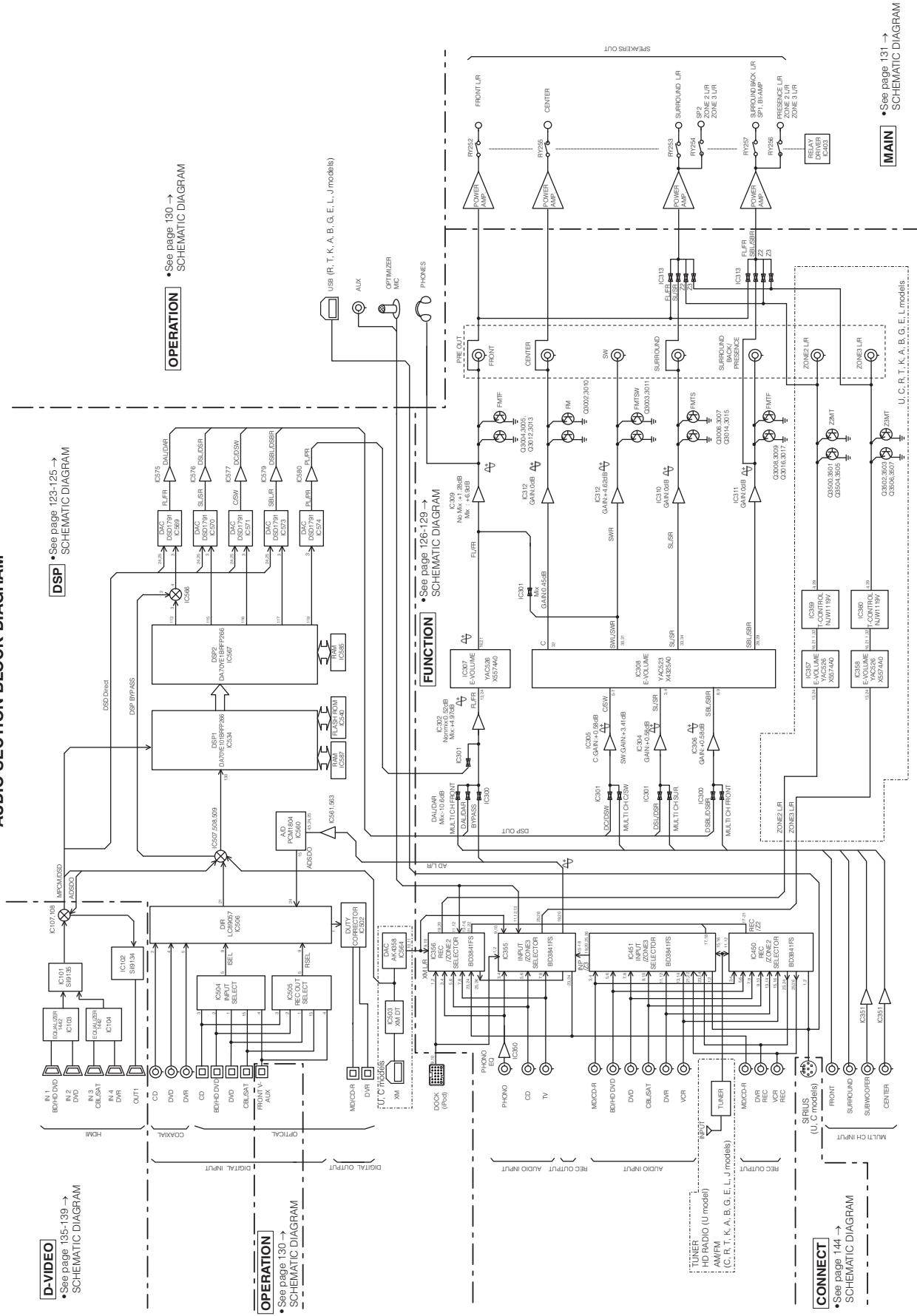

VIDEO SECTION BLOCK DIAGRAM

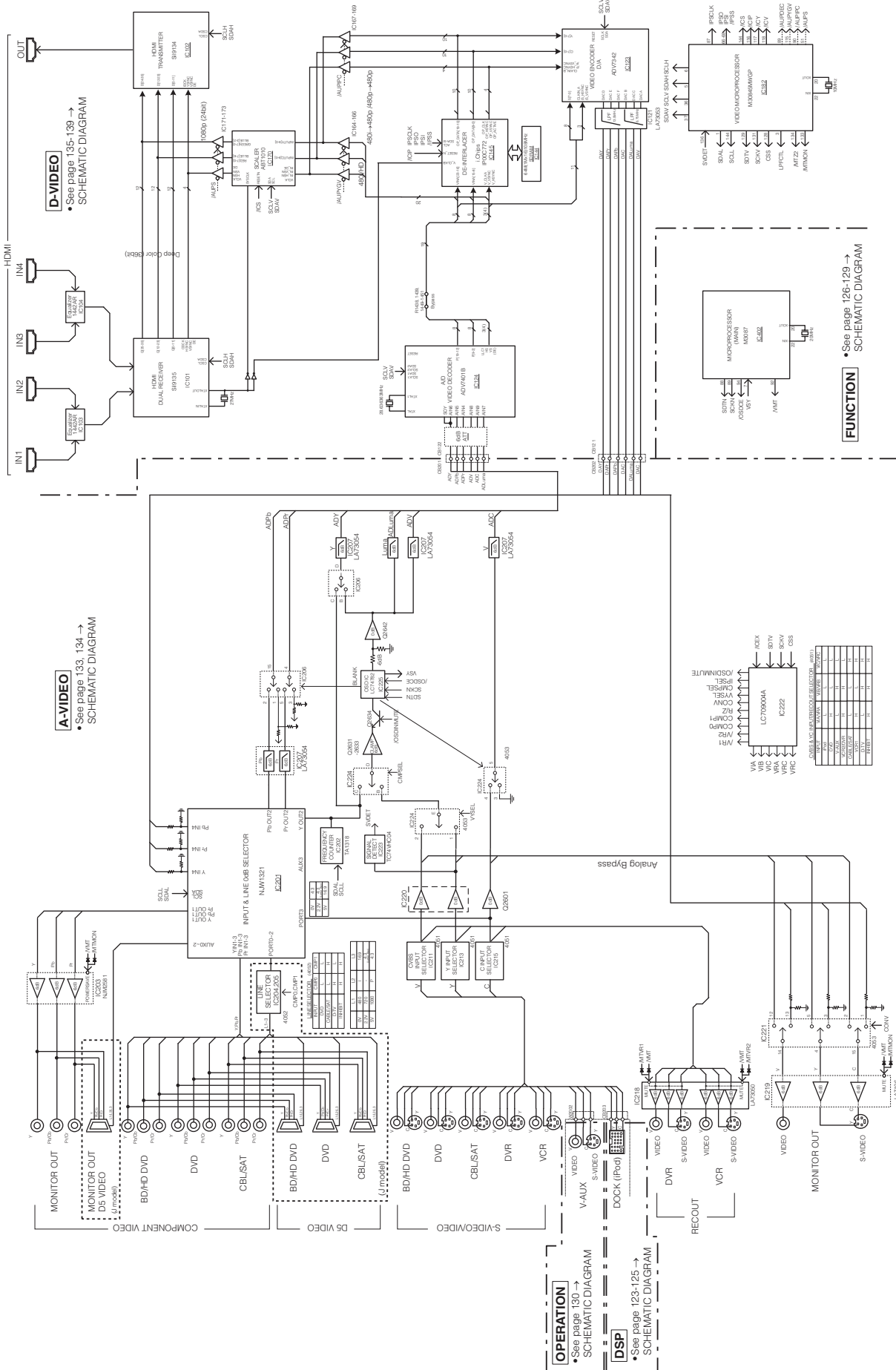

CONTROL/POWER SECTION BLOCK DIAGRAM

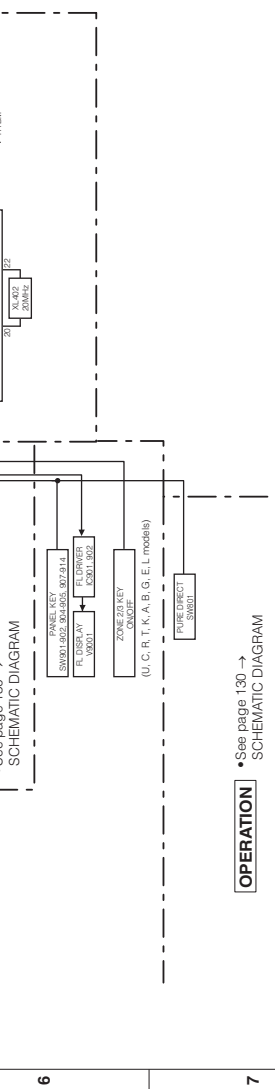
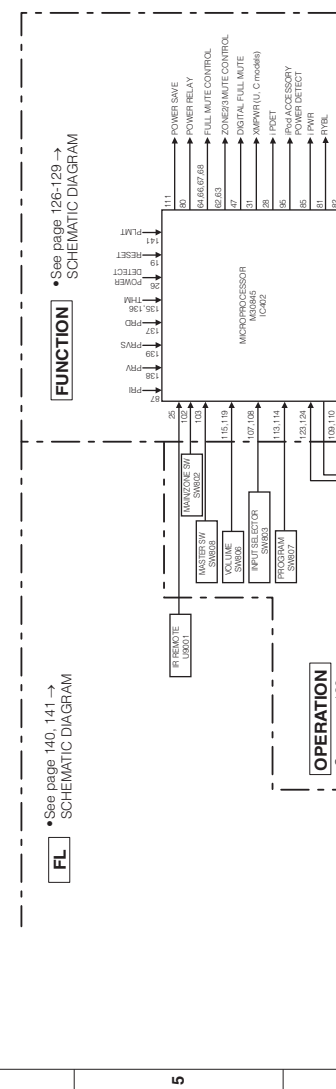
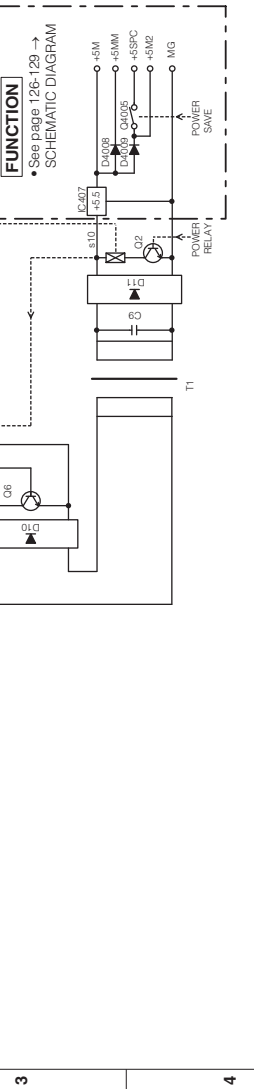
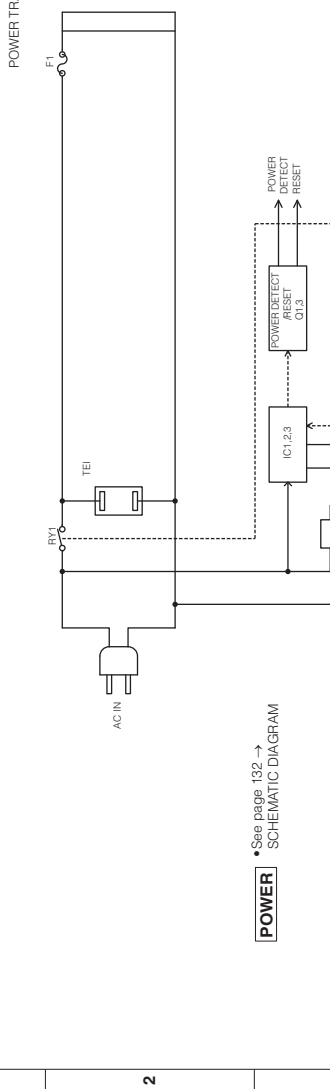
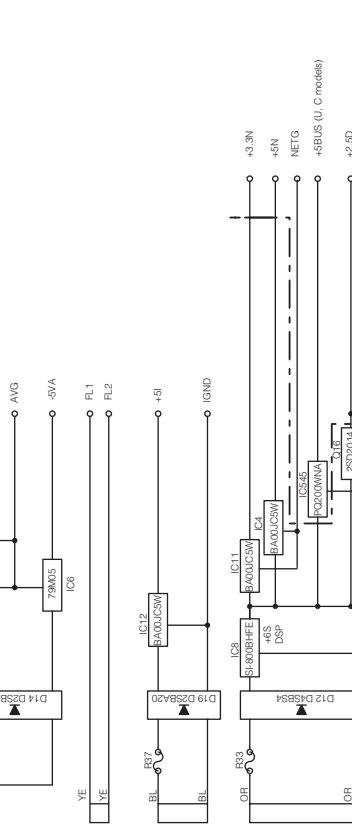
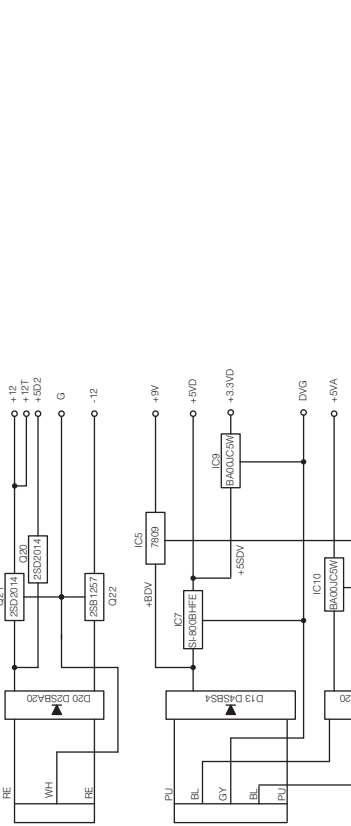
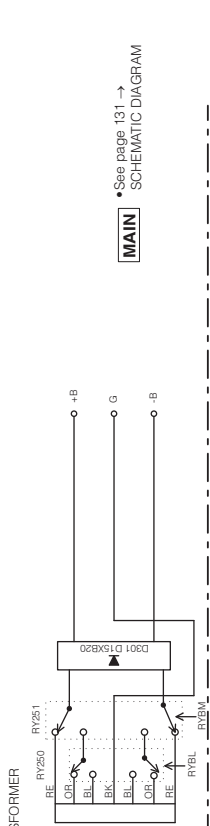
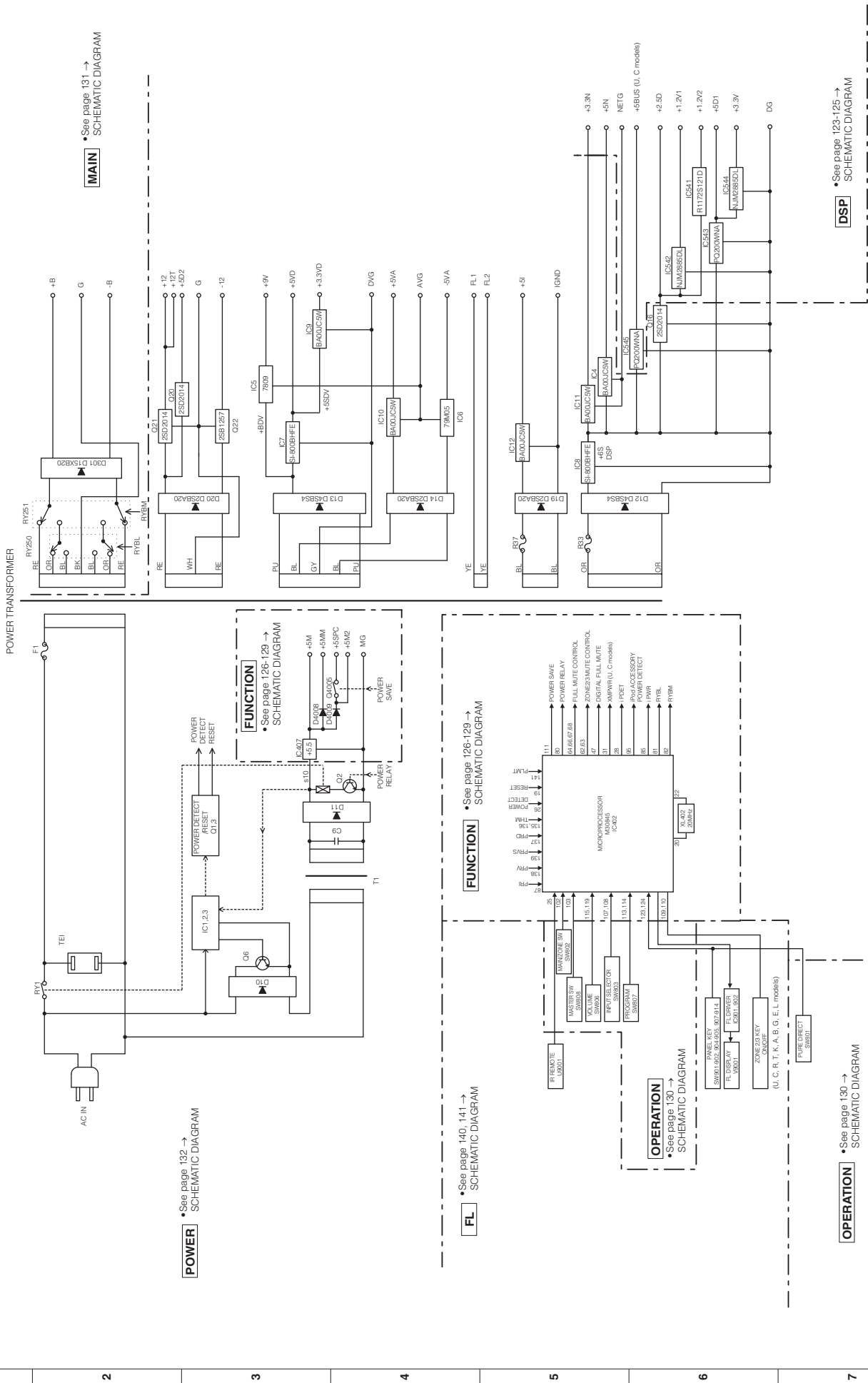

NET SECTION BLOCK DIAGRAM (R, T, K, A, B, G, E, L, J models)

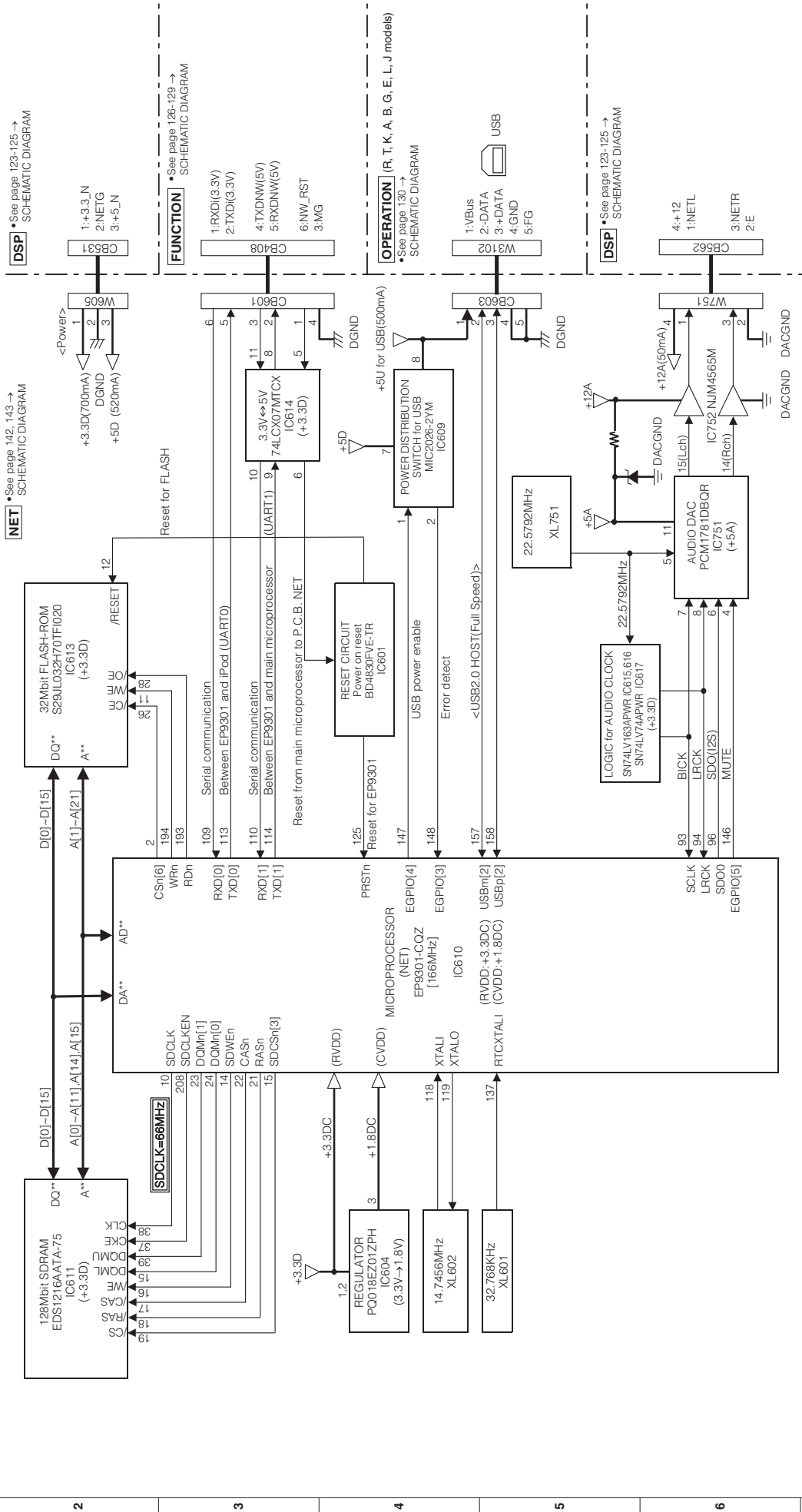

PRINTED CIRCUIT BOARDS

DSP P.C.B. (Side A)

DIGITAL INPUT — — DIGITAL OUTPUT —
 COAXIAL DVD DVD DVD CBL/SAT MD/CD-R DVR
 TV BD/HD DVD DVD CBL/SAT MD/CD-R DVR
 OPTICAL

No replacement part available.
 サービス部品供給なし

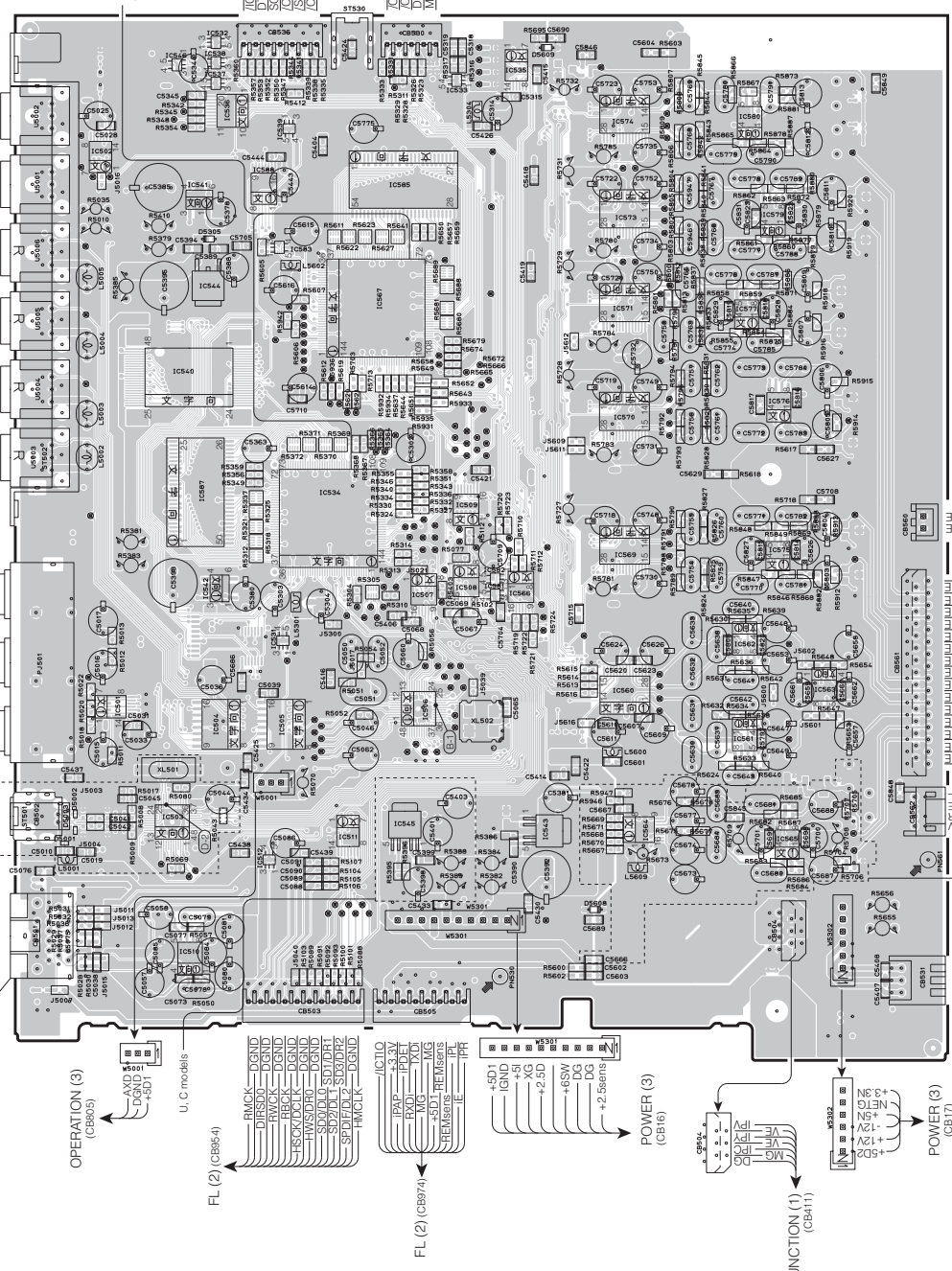
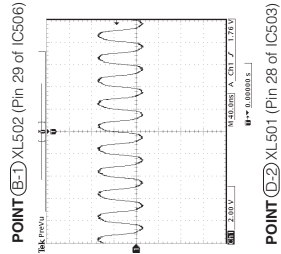

No replacement part available.
 サービス部品供給なし

- IC501 - XMPWM
- IC502 - DRXM
- IC503 - SCK
- IC504 - SDD
- IC505 - SPTD
- IC506 - SPTD
- IC507 - SPTD
- IC508 - SPTD
- IC509 - SPTD
- IC510 - SPTD
- IC511 - SPTD
- IC512 - SPTD
- IC513 - SPTD
- IC514 - SPTD
- IC515 - SPTD
- IC516 - SPTD
- IC517 - SPTD
- IC518 - SPTD
- IC519 - SPTD
- IC520 - SPTD
- IC521 - SPTD
- IC522 - SPTD
- IC523 - SPTD
- IC524 - SPTD
- IC525 - SPTD
- IC526 - SPTD
- IC527 - SPTD
- IC528 - SPTD
- IC529 - SPTD
- IC530 - SPTD
- IC531 - SPTD
- IC532 - SPTD
- IC533 - SPTD
- IC534 - SPTD
- IC535 - SPTD
- IC536 - SPTD
- IC537 - SPTD
- IC538 - SPTD
- IC539 - SPTD
- IC540 - SPTD
- IC541 - SPTD
- IC542 - SPTD
- IC543 - SPTD
- IC544 - SPTD

• Semiconductor Location

Ref no.	Location	Ref no.	Location
D5001	D2	IC542	F3
D5002	E2	IC543	D5
D5003	E2	IC544	G3
D5305	G3	IC545	E4
D5306	G3	IC546	H4
D5608	D5	IC560	E5
D5609	H5	IC561	E6
IC501	E2	IC562	E6
IC502	H2	IC563	E6
IC503	E3	IC564	E5
IC504	E3	IC565	D6
IC505	E3	IC566	F4
IC506	E4	IC567	G4
IC507	E4	IC569	F5
IC508	F4	IC570	G5
IC509	F4	IC571	G5
IC510	D4	IC573	H5
IC511	D3	IC574	H5
IC512	D3	IC575	F6
IC531	E3	IC576	G6
IC532	H3	IC577	G6
IC533	F3	IC579	H6
IC534	F3	IC580	H6
IC535	H4	IC581	F4
IC536	H3	IC582	F4
IC537	H3	IC583	G3
IC538	H3	IC585	H4
IC539	H3	IC587	F3
IC540	G3	IC588	H3
IC541	H3		

Circuit No.	U, C	R, T, K, A, B, G, E, L, J
R5077, 5102	X	O

X : NOT USED
 O : USED/APPLICABLE

DSP P.C.B. (Side B)

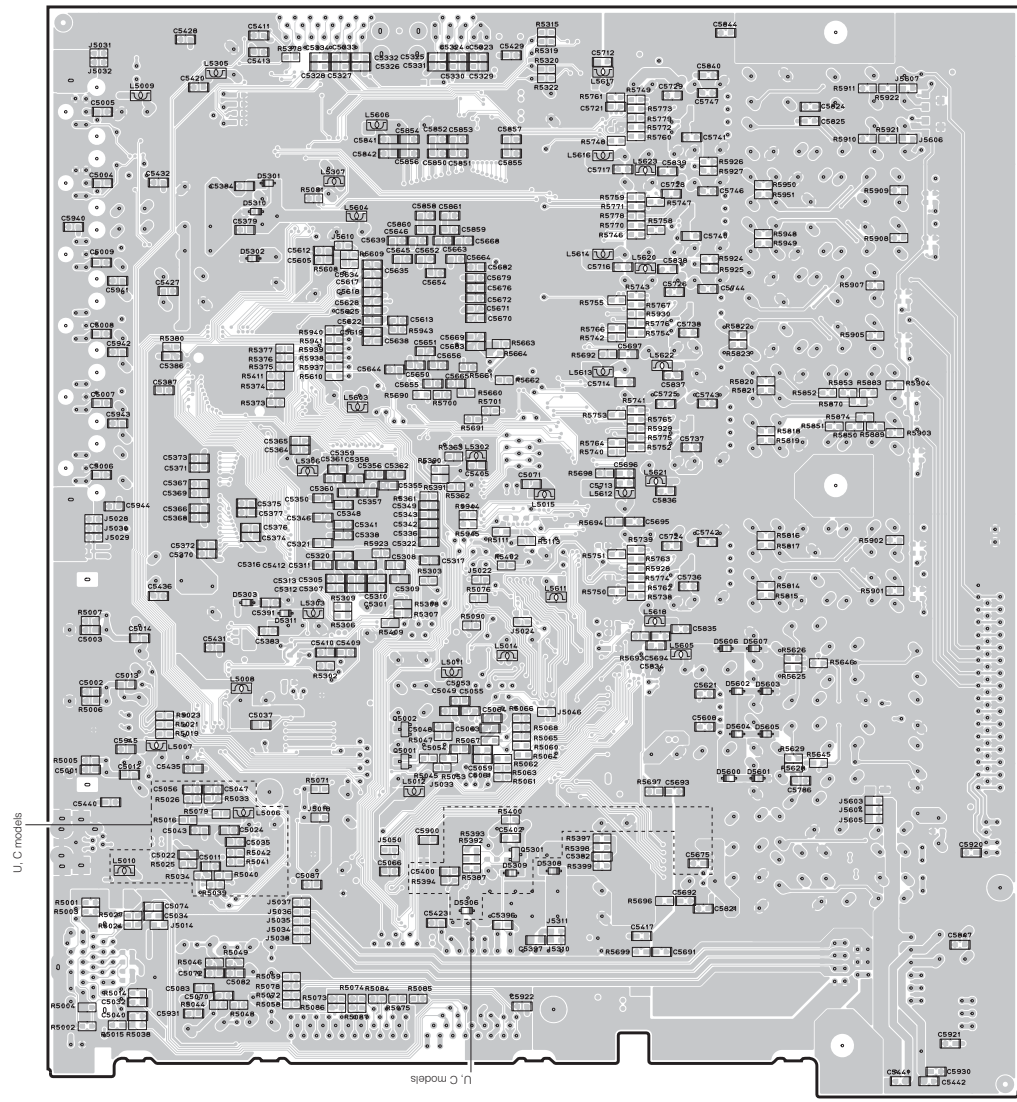

• Semiconductor Location

Ref no.	Location
D5301	H3
D5302	G3
D5303	F3
D5308	D4
D5309	D4
D5310	D4
D5311	G3
D5600	F3
D5601	E5
D5602	E5
D5603	E5
D5604	E5
D5605	E5
D5606	E5
D5607	E5
Q5001	E2
Q5002	E2
Q5301	D4

Circuit No.	U C	R, T, K, A, B, G, E, L, J
R5076, S090	X	O

X: NOT USED
O: USED/APPLICABLE

FUNCTION (1) P.C.B. (Side A)

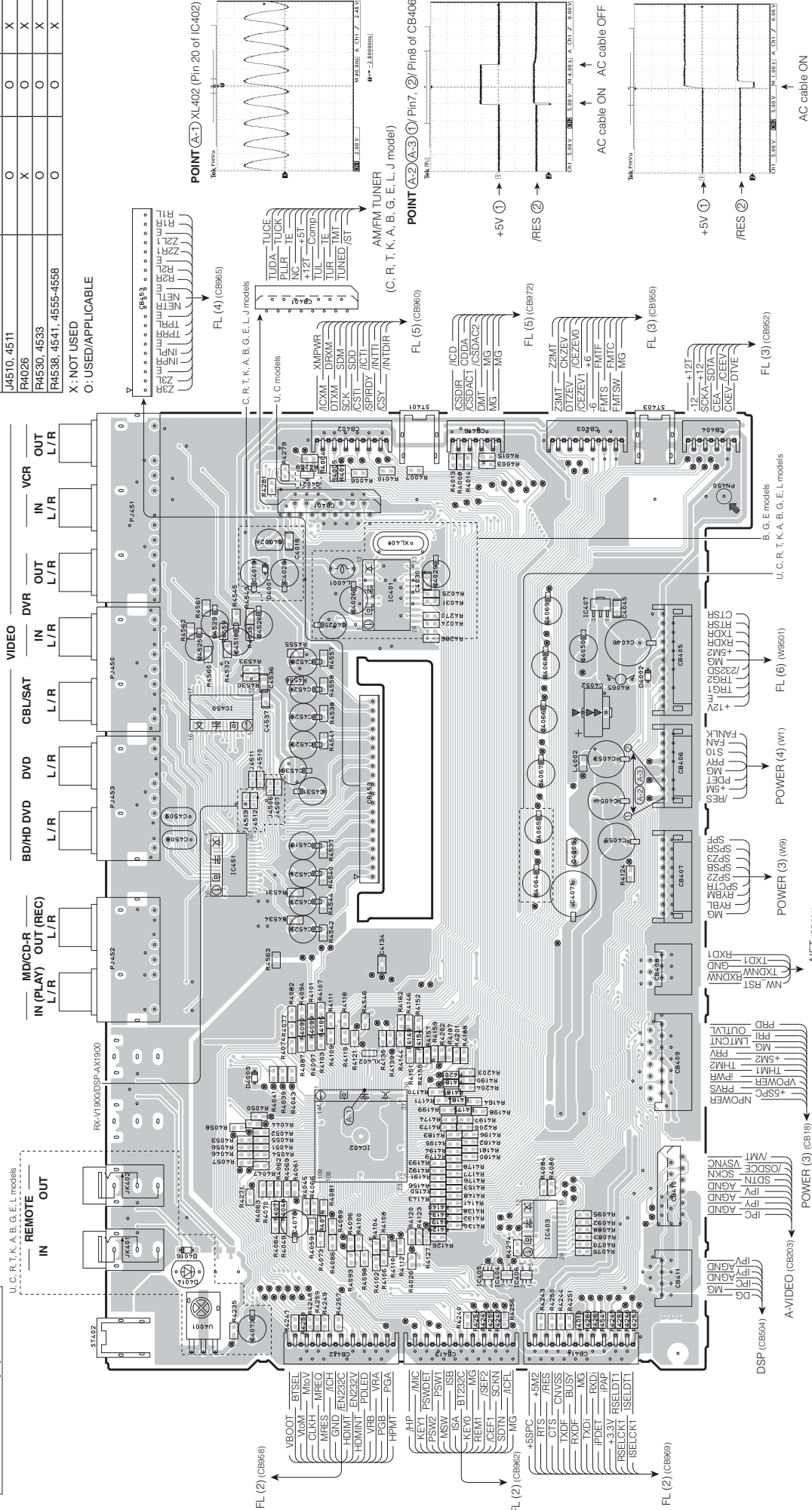

Circuit No.	U, C, R, T, K, A, L	B, G, E	J
IC4520, 4521, 4523, 4528	O	O	X
IC450	O	O	X
J4506, 4507, 4512, 4513	X	X	O
J4510, 4511	O	O	X
R4026	X	O	X
R4530, 4533	O	O	X
R4538, 4541, 4555-4558	O	O	X
X: NOT USED			
O: USED/APPLICABLE			

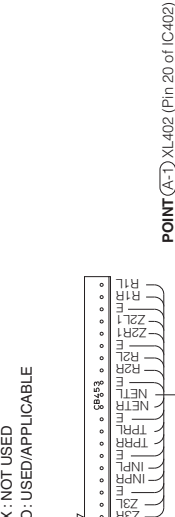

FL (2) (CB869)

VBOOT	BTSLEP
WMA	M0V
CLKM	MREQ
MRES	JICH
GND	EN232C
HDIMT	EN292V
HDIMT	POLED
VFB	VRA
PGB	PGA
HPMT	
AHP	
KEY1	MIC
PSWDE1	PSW1
MSW	PSW2
ISA	ISB
KEY0	BT222C
REMT	/SEF2
/JCF1	SCRN
SDTN	JCHL
MG	
+5M2	
/RES	
CIS	CVSS
TXDF	BUSY
MG	
TXDI	
IPDET	FXDI
+3.3V	IPAP
RSELDT1	
RSELCK	ISELDT1
ISELCKT	

FL (3) (CB885)

Z3MT	Z3MT
DIZEV	CKZEV
/ZEVE1	+6
FMIS	FMTC
FMTSW	MG
SCKA	+12
SCKA	+12
SATA	CEA
AGEV	AGEV
CKEV	DIVE

FL (4) (CB865)

TUDA	TUCC
PILLR	TE
NC	+5T
+12T	Comp
TUL	TE
TUR	TE
IMT	
TUNED	/ST

FL (5) (CB872)

/JCD	
/CSDAC1	
/CSDAC2	
DMT	MG
MG	
Z3MT	
DIZEV	
/ZEVE1	
+6	
FMIS	
FMTC	
FMTSW	
MG	

FL (6) (W501)

+12T	
SCKA	+12
SATA	CEA
AGEV	AGEV
CKEV	DIVE

• Semiconductor Location

Ref no.	Location	Ref no.	Location	Ref no.	Location
D4001	G3	IC401	B5	Q4009	E5
D4002	F5	IC402	C4	Q4021	G3
D4003	D3	IC403	C5	IC450	F3
D4014	B3	IC404	B5	IC451	E3
D4016	C3	IC405	B4	Q4002	G3

FUNCTION (1) P.C.B. (Side B)

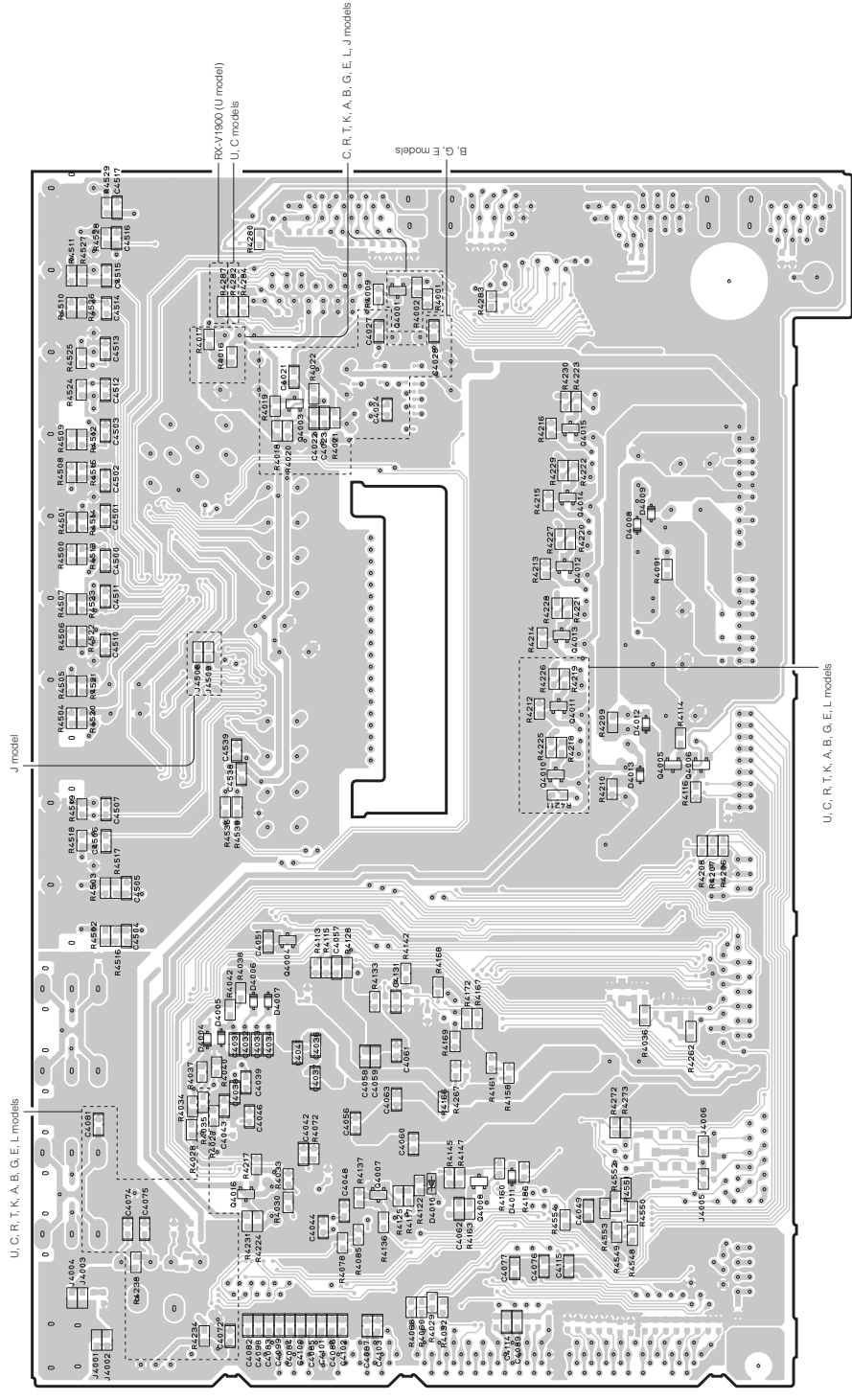

• Semiconductor Location

Ref no.	Location
D4004	C3
D4005	C3
D4006	D3
D4007	D3
D4008	F5
D4009	F5
D4010	C4
D4011	C4
D4012	E5
D4013	E5
Q4001	G4
Q4003	G3
Q4004	D3
Q4005	E5
Q4006	E5
Q4007	C4
Q4008	C4
Q4010	E5
Q4011	E5
Q4012	F5
Q4013	E5
Q4014	F5
Q4015	F5
Q4016	C3

Circuit No.	U.C	R	T	K	A	B	G	E	L	J
C3601, 3610	O									X
IC310, 311	X									O
IC356	O									X
J3003-3006	O									X
J3544-3545, 3548, 3549	X									X
J3546, 3647	O									X
R3605, 3606, 3620, 3621	O									X

X : NOT USED
O : USED/APPLICABLE

FUNCTION (2) P.C.B. (Side A)

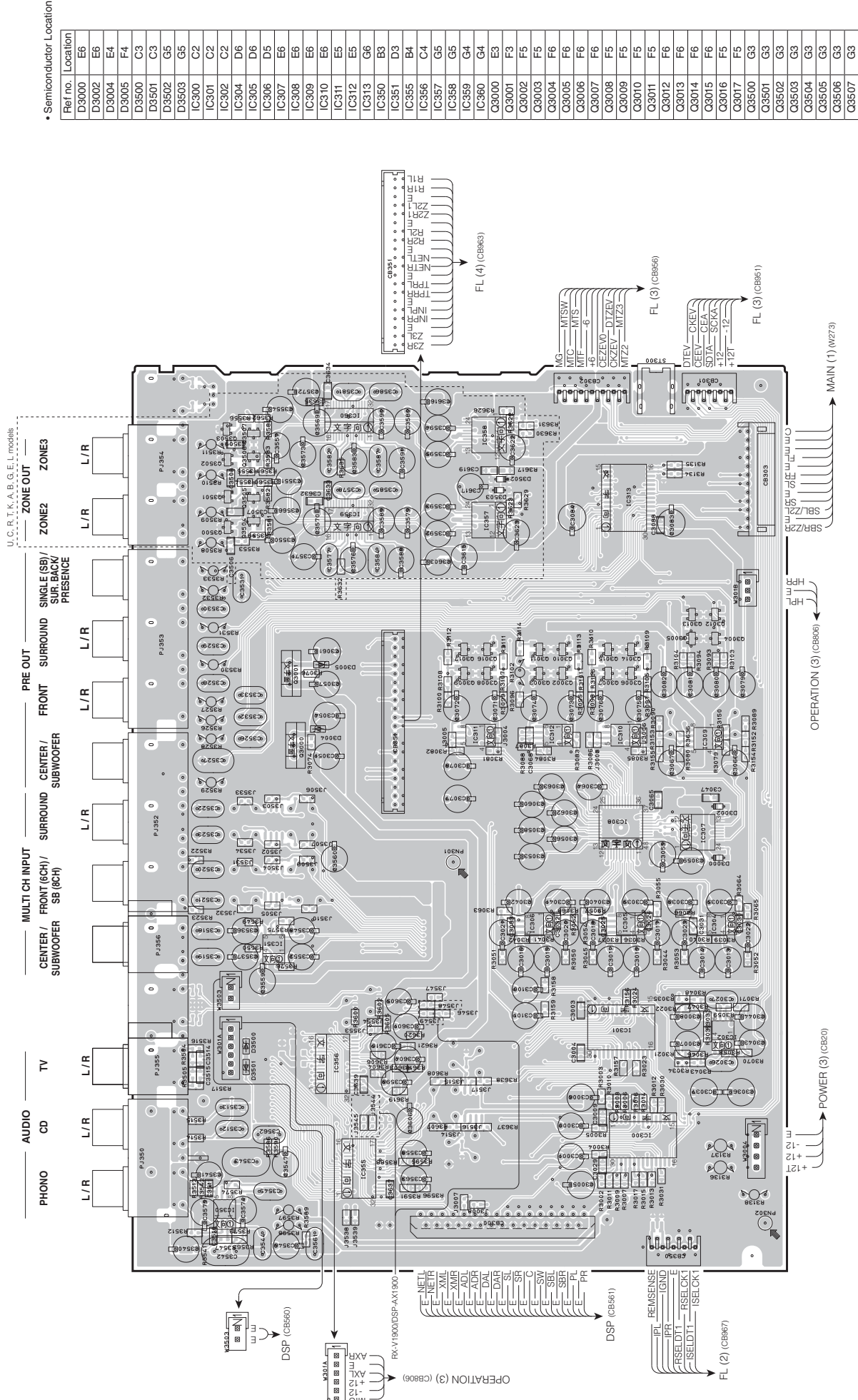

• Semiconductor Location

Ref no.	Location
D3000	E6
D3002	E6
D3004	E4
D3005	F4
D3500	C3
D3501	C3
D3502	G5
D3503	G5
IC300	C2
IC301	C2
IC302	C2
IC304	D6
IC305	D6
IC306	D5
IC307	E6
IC308	E6
IC309	E6
IC310	E6
IC311	E5
IC312	E5
IC313	G6
IC350	B3
IC351	D3
IC355	B4
IC356	C4
IC357	G5
IC358	G5
IC359	G4
IC360	G4
Q3000	E3
Q3001	F3
Q3002	F5
Q3003	F5
Q3004	F6
Q3005	F6
Q3006	F6
Q3007	F6
Q3008	F5
Q3009	F5
Q3010	F5
Q3011	F5
Q3012	F6
Q3013	F6
Q3014	F6
Q3015	F6
Q3016	F5
Q3017	F5
Q3500	G3
Q3501	G3
Q3502	G3
Q3503	G3
Q3504	G3
Q3505	G3
Q3506	G3
Q3507	G3

FUNCTION (2) P.C.B. (Side B)

R, T, K, A, B, G, E, L models

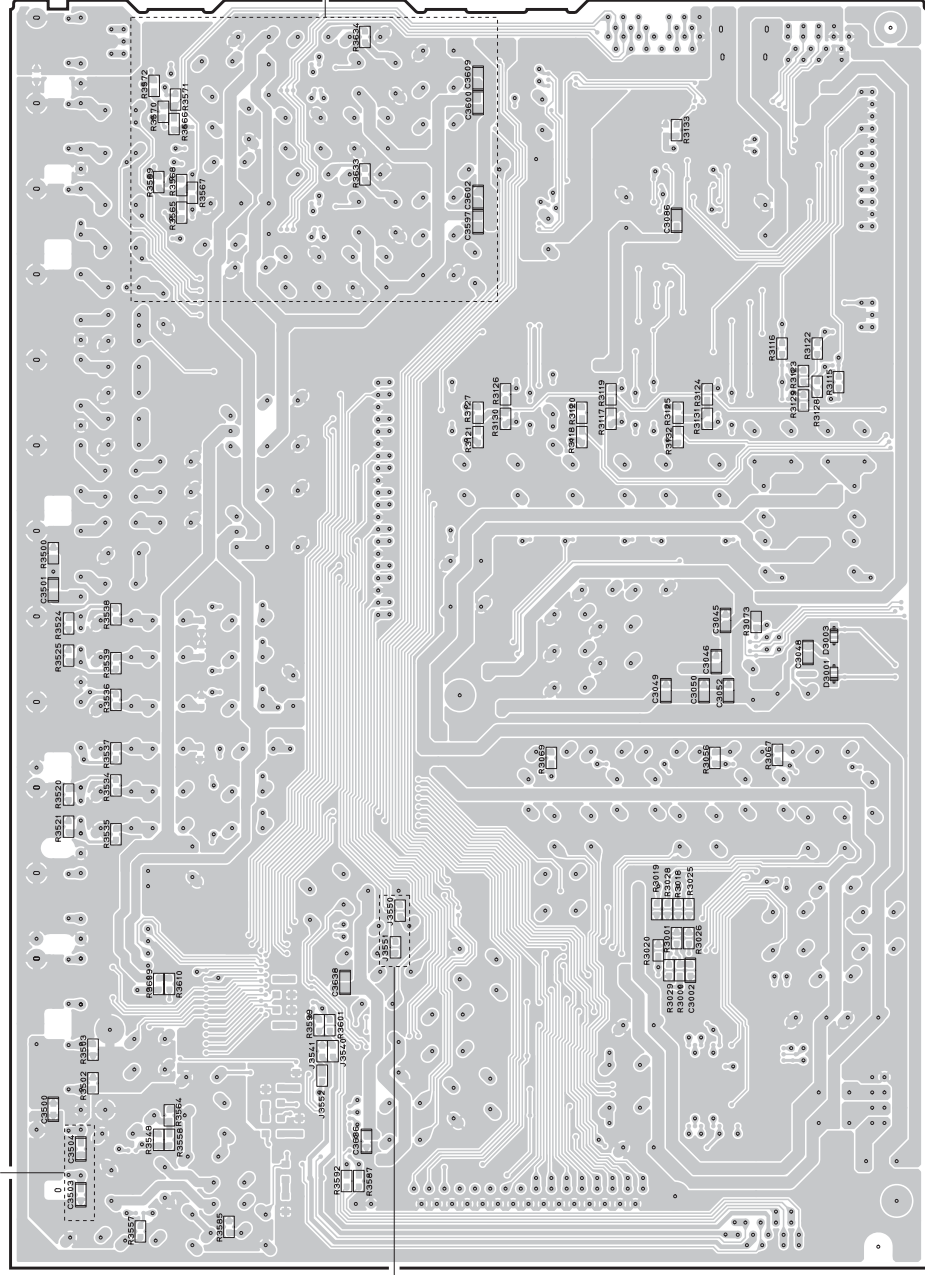

U, C, R, T, K, A, B, G, E, L models

• Semiconductor Location

Ref no.	Location
D3001	E6
D3003	E6

OPERATION (1) P.C.B. (Side A)

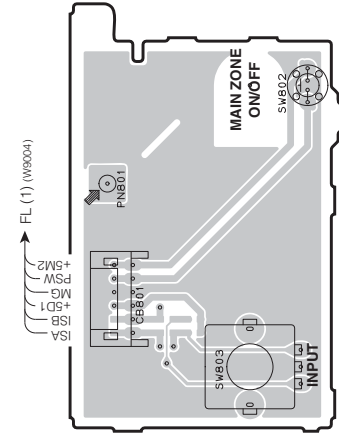

OPERATION (2) P.C.B. (Side A)

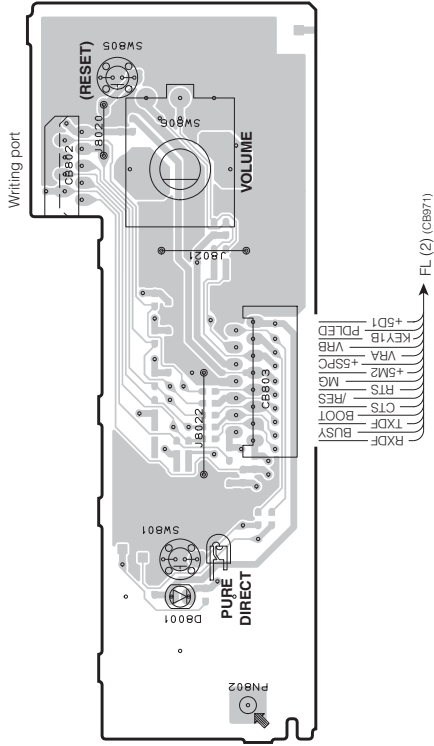

OPERATION (3) P.C.B. (Side A)

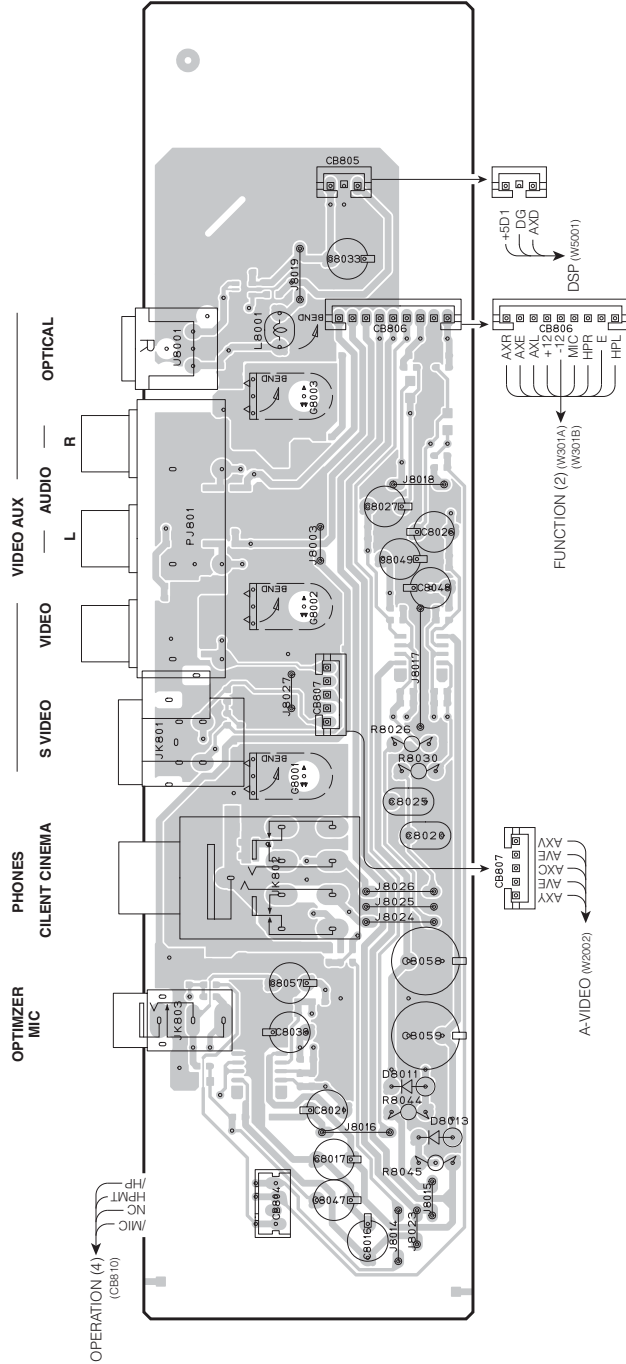

• Semiconductor Location

Ref no.	Location
D8001	F2
D8011	C6
D8013	C6

1

OPERATION (1) P.C.B. (Side B)

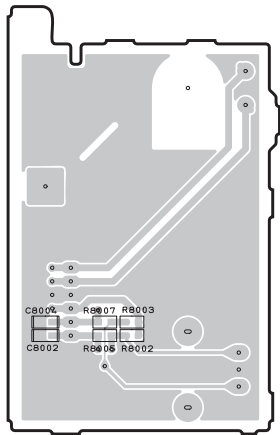

2

OPERATION (2) P.C.B. (Side B)

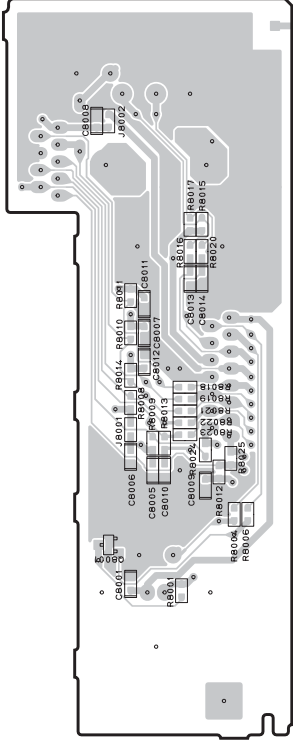

3

OPERATION (3) P.C.B. (Side B)

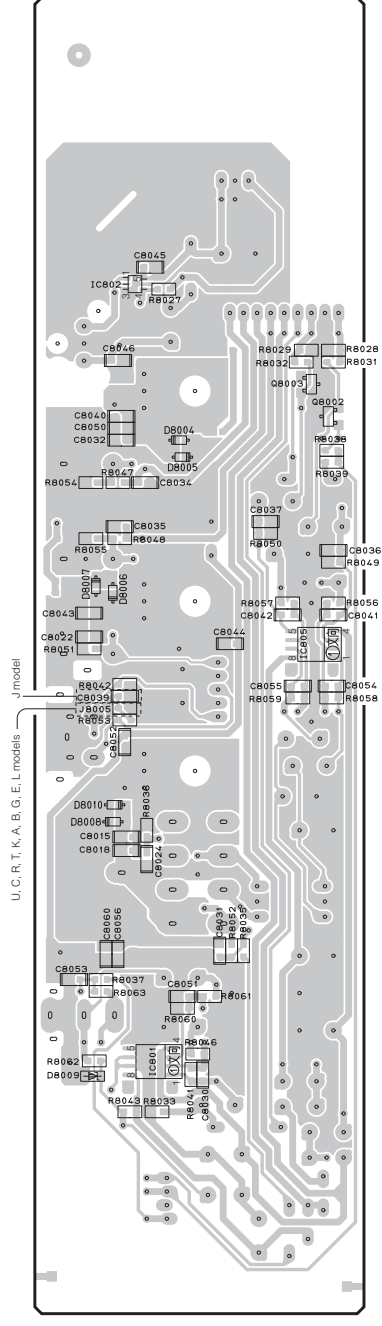

5

• Semiconductor Location

Ref no.	Location
D8004	F5
D8005	F5
D8006	E5
D8007	E5
D8008	D5
D8009	C5
D8010	D5
IC801	C5
IC802	G5
IC805	F6
Q8001	F2
Q8002	F6
Q8003	F6

7

OPERATION (4) P.C.B. (Side A)

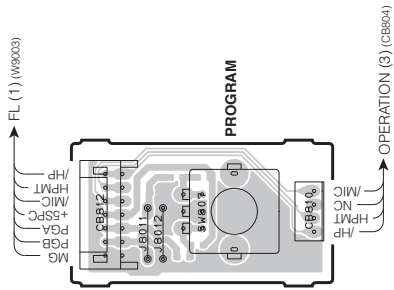

OPERATION (6) P.C.B. (Side A)

R, T, K, A, B, G, E, L, J models

OPERATION (5) P.C.B. (Side A)

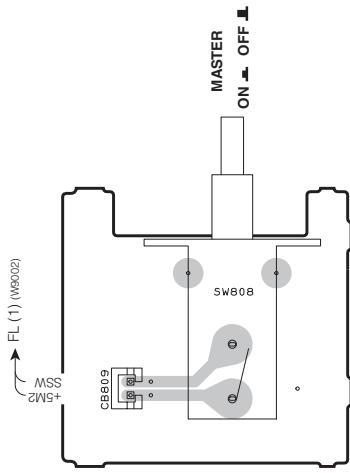

OPERATION (7) P.C.B. (Side A)

R, T, K, A, B, G, E, L, J models

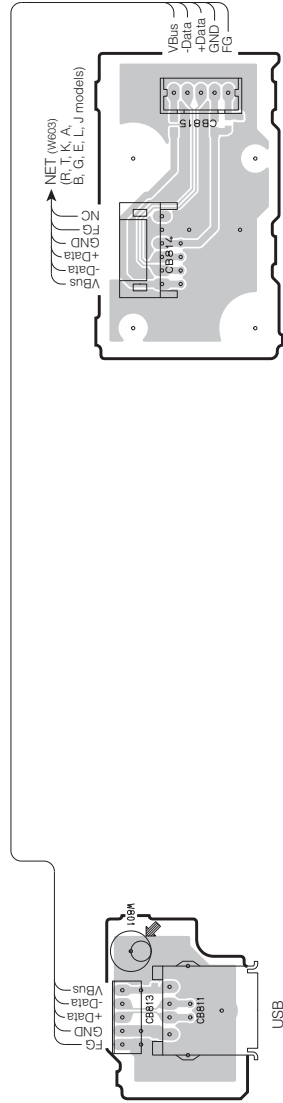

A B C D E F G H I J

1

OPERATION (4) P.C.B. (Side B)

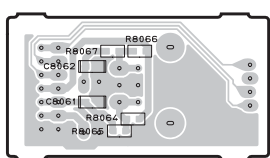

2

OPERATION (5) P.C.B. (Side B)

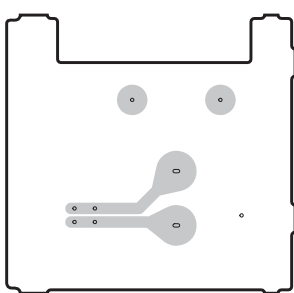

3

4

OPERATION (6) P.C.B. (Side B)



OPERATION (7) P.C.B. (Side B)

R, T, K, A, B, G, E, L, J models

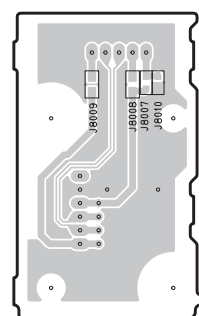

5

6

7

MAIN (1) P.C.B. (Side A)

• Semiconductor Location

Ref no.	Location	Ref no.	Location	Ref no.	Location	Ref no.	Location	Ref no.	Location	Ref no.	Location	Ref no.	Location
D279	I4	Q278	I5	Q293	I3	Q307A	I3	Q310C	E3	Q360	I3	Q367	F3
D280	H4	Q279	I5	Q294	H3	Q307C	I3	Q311A	E3	Q361	I4	Q368	D3
D281	G4	Q280	H5	Q295	G3	Q308A	H3	Q311C	D3	Q362	H3	Q369	E3
D282	F4	Q281	G5	Q296	F3	Q308C	H3	Q312A	D3	Q363	H3	Q370	C3
D283	E4	Q282	F5	Q297	E3	Q309A	G3	Q312C	C3	Q364	F3	Q371	C4
D284	D4	Q283	E5	Q298	D3	Q309C	G3	Q313A	C3	Q365	G3	Q372	B4
D285	C5	Q284	E5	Q299	B3	Q310A	F3	Q313C	E3	Q366	E3	Q373	C4

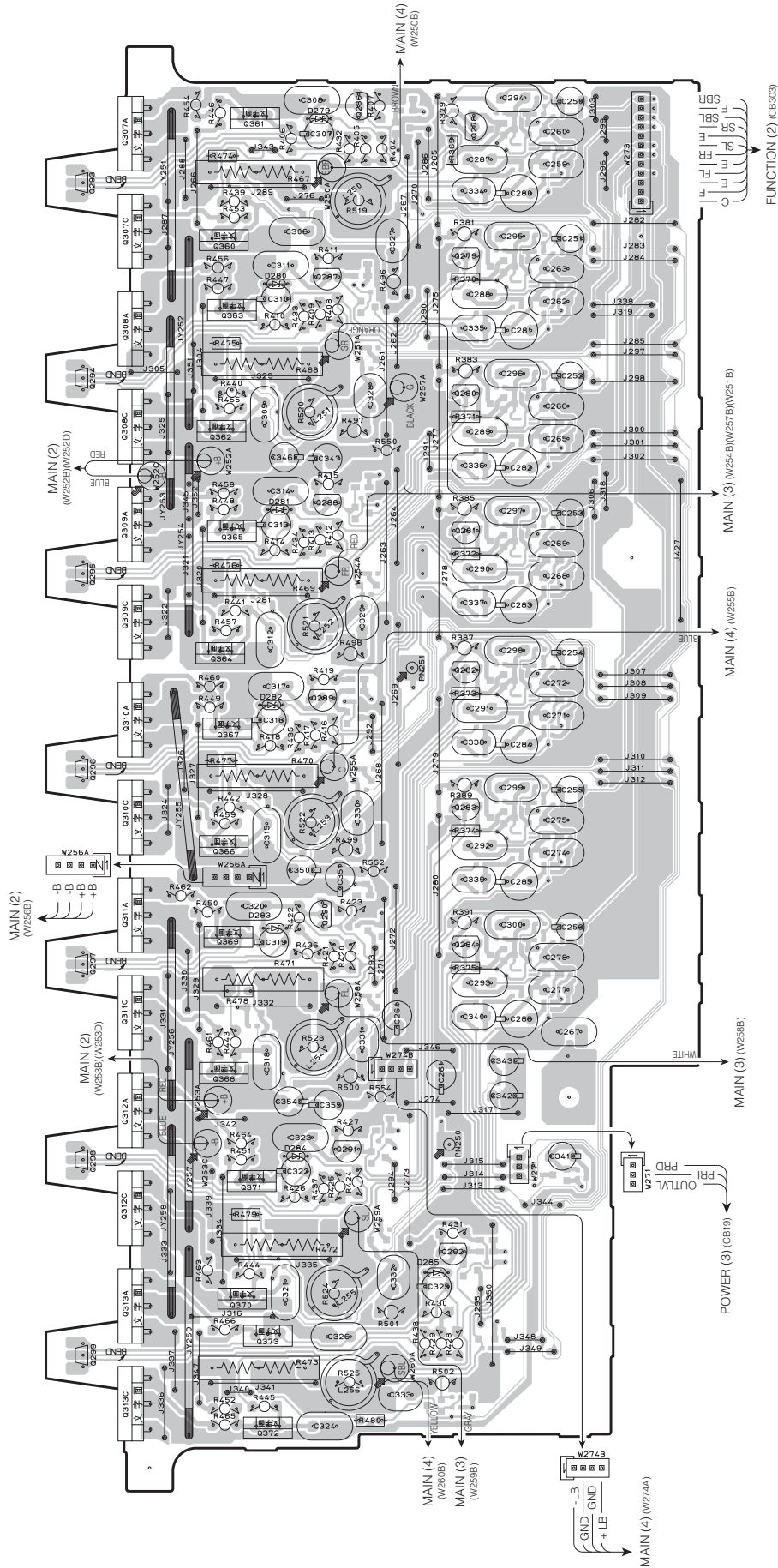

MAIN (1) P.C.B. (Side B)

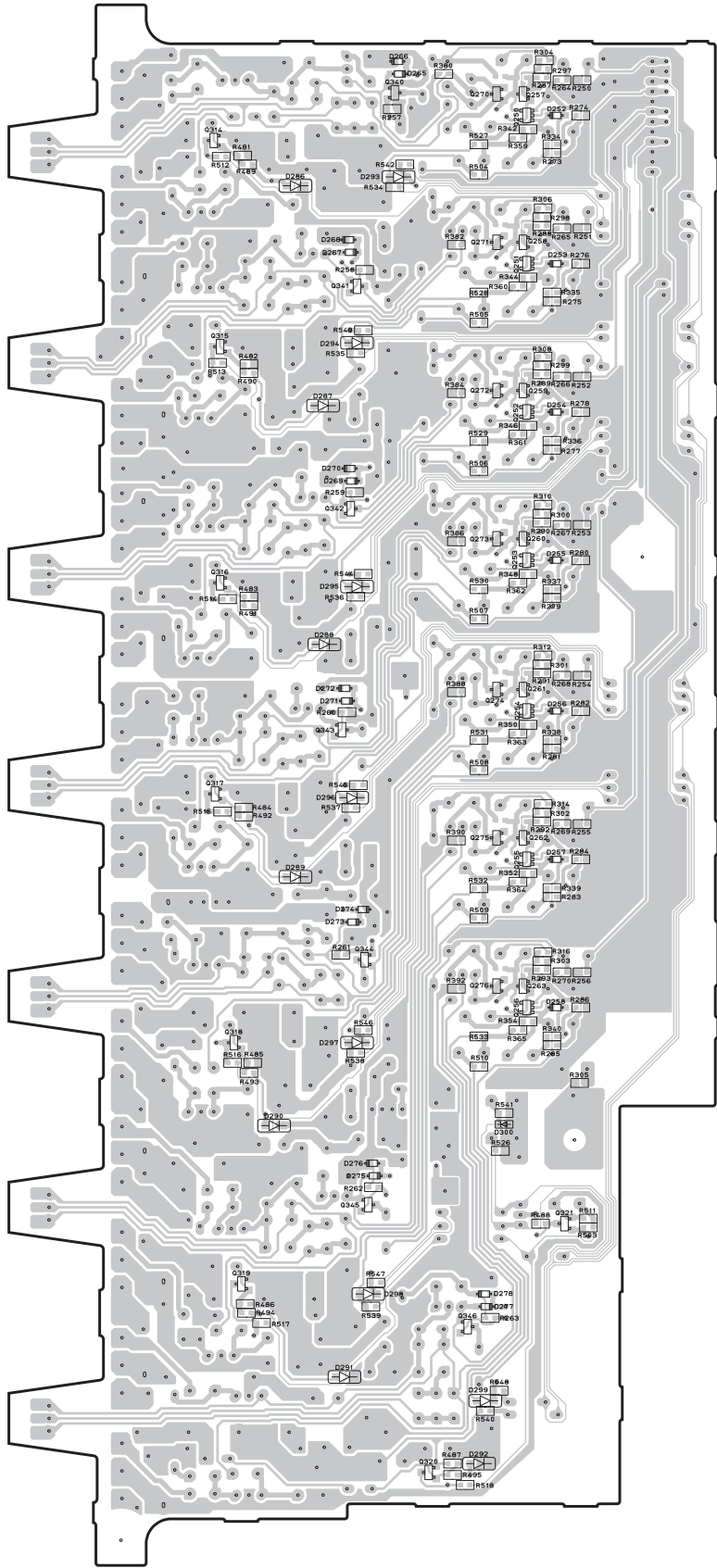

• Semiconductor Location

Ref no.	Location	Ref no.	Location	Ref no.	Location	Ref no.	Location	Ref no.	Location	Ref no.	Location	Ref no.	Location
D252	I5	D265	I4	D272	F4	D286	I4	D293	I4	Q263	E5	Q276	E5
D253	H5	D266	I4	D273	E4	D287	H4	D294	H4	Q270	I5	Q314	I3
D254	G5	D267	H4	D274	E4	D288	F4	D295	G4	Q271	H5	Q315	H3
D255	G5	D268	H4	D275	E4	D289	E4	D296	E4	Q272	H5	Q316	G3
D256	F5	D269	G4	D276	D4	D290	D4	D297	D4	Q273	G5	Q317	E4
D257	E5	D270	G4	D277	C5	D291	B4	D298	C4	Q274	F5	Q318	D4
D258	D5	D271	F4	D278	C5	D292	B5	D299	B5	Q275	E5	Q319	C4
												Q320	B5
												Q321	C5
												Q340	I4
												Q341	H4
												Q342	G4
												Q343	F4
												Q344	E4
												Q345	C4
												Q346	C5

MAIN (2) P.C.B. (Side A)

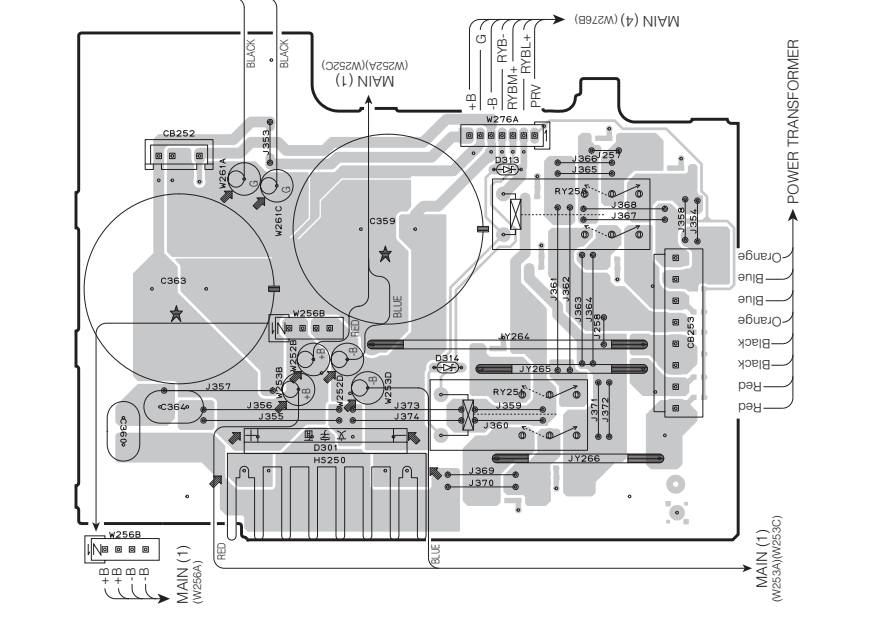

MAIN (3) P.C.B. (Side A)

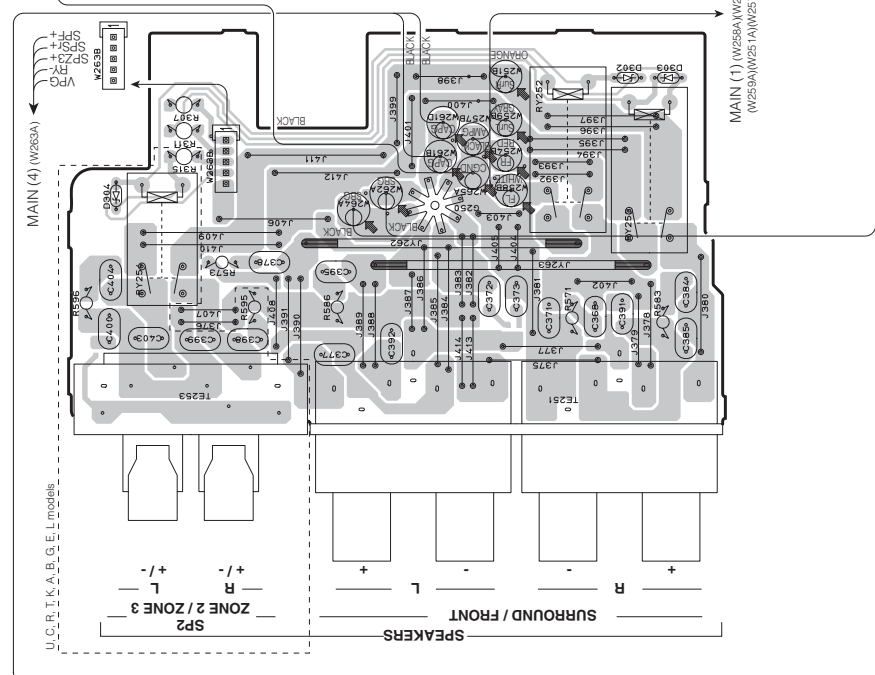

MAIN (4) P.C.B. (Side A)

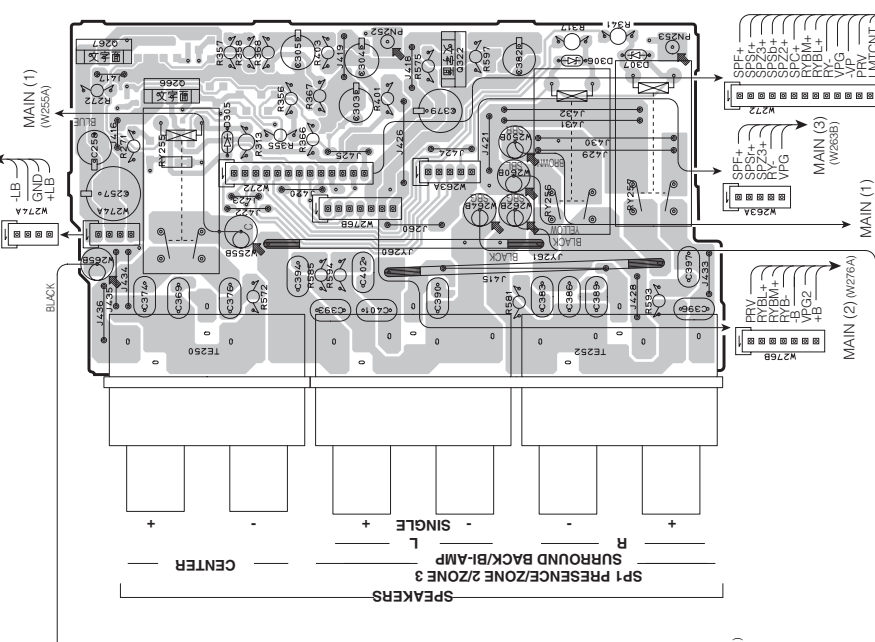

• Semiconductor Location

Ref no.	Location	Ref no.	Location
D301	B3	D307	J5
D302	G5	D313	C4
D303	G5	D314	B4
D304	F2	Q266	J2
D305	J3	Q267	J2
D306	J4	Q322	J4

Circuit No.	U.C.R.T.K.A.B.G.E.L	J
D313		X
R57.258	O	O
RY250		X

X: NOT USED
O: USED/APPLICABLE

MAIN (2) P.C.B. (Side B)

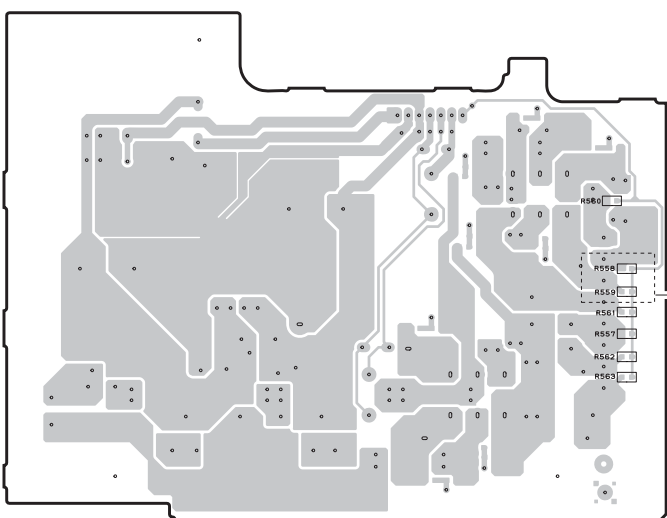

U.C.R.T.K.A.B.G.E.L models

MAIN (3) P.C.B. (Side B)

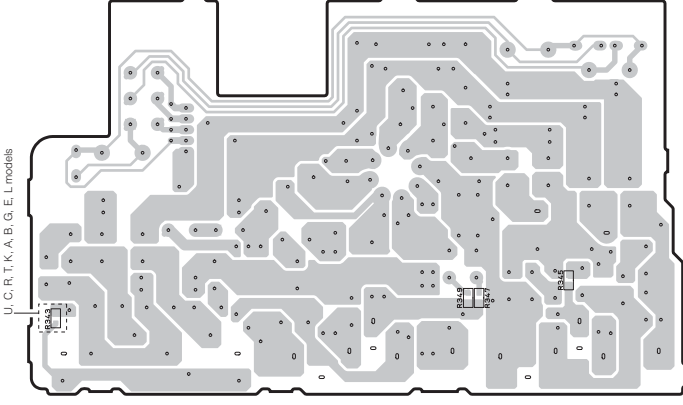

U.C.R.T.K.A.B.G.E.L models

MAIN (4) P.C.B. (Side B)

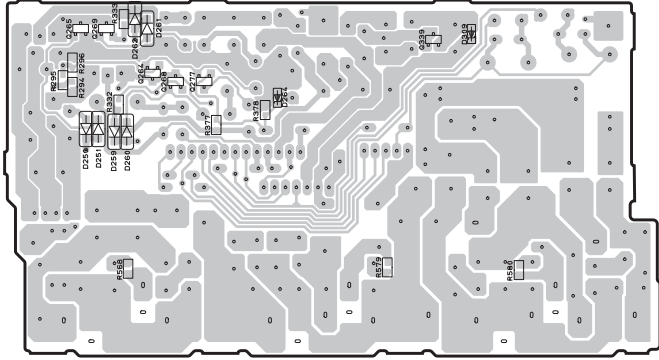

• Semiconductor Location

Ref no.	Location	Ref no.	Location
D250	I2	D309	J4
D251	I2	Q264	J3
D259	I2	Q265	J2
D260	I3	Q268	J3
D261	J3	Q269	J2
D262	J3	Q277	J3
D264	J3	Q339	J4

POWER (2) P.C.B. (Side A)

R, L models

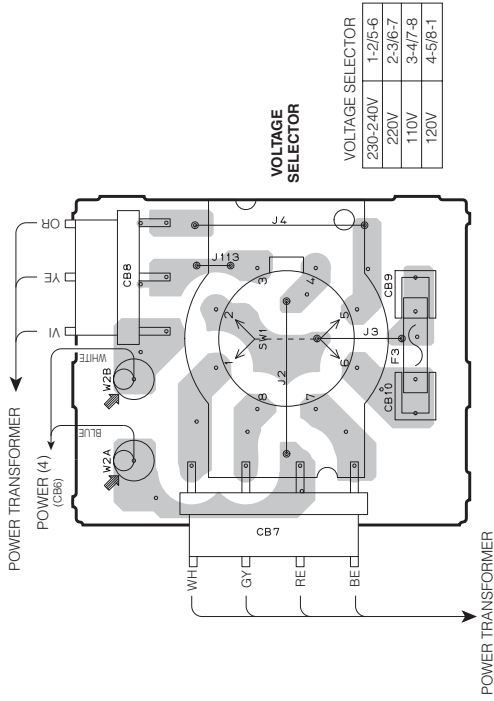

POWER (6) P.C.B. (Side A)

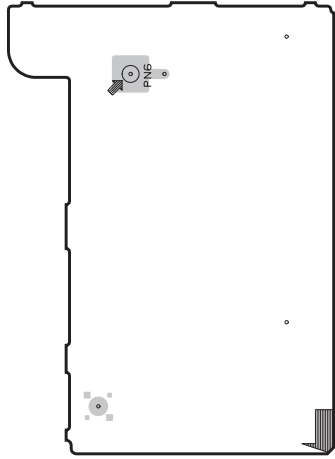

POWER (5) P.C.B. (Side A)

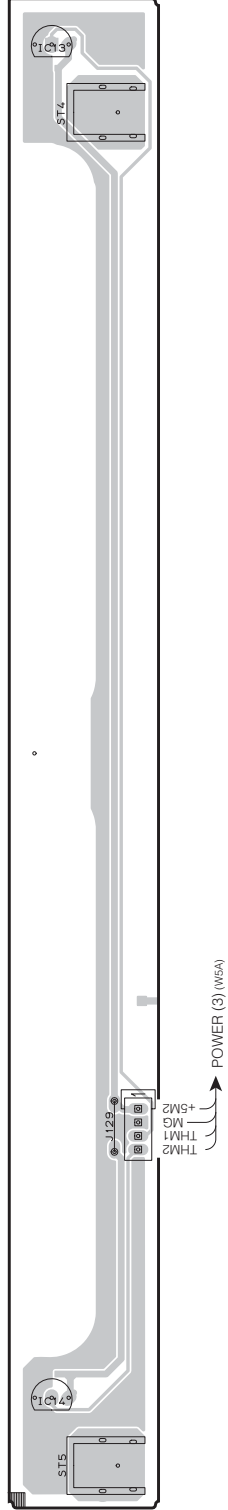

POWER (5) P.C.B. (Side B)

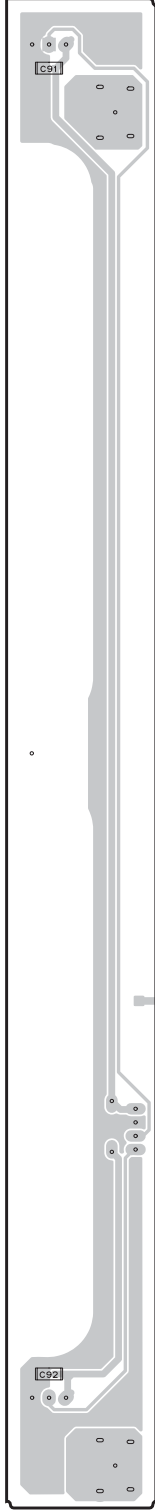

• Semiconductor Location

Ref no.	Location
IC13	B5
IC14	B5

POWER (3) P.C.B. (Side A)

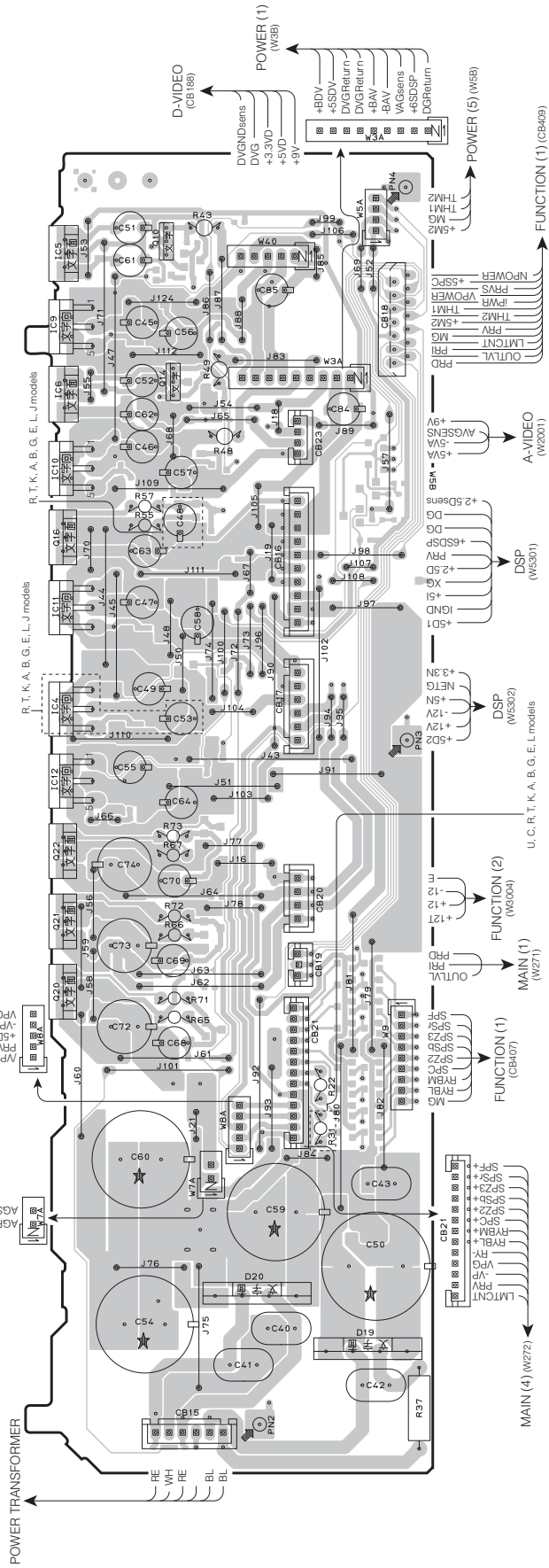

POWER (3) P.C.B. (Side B)

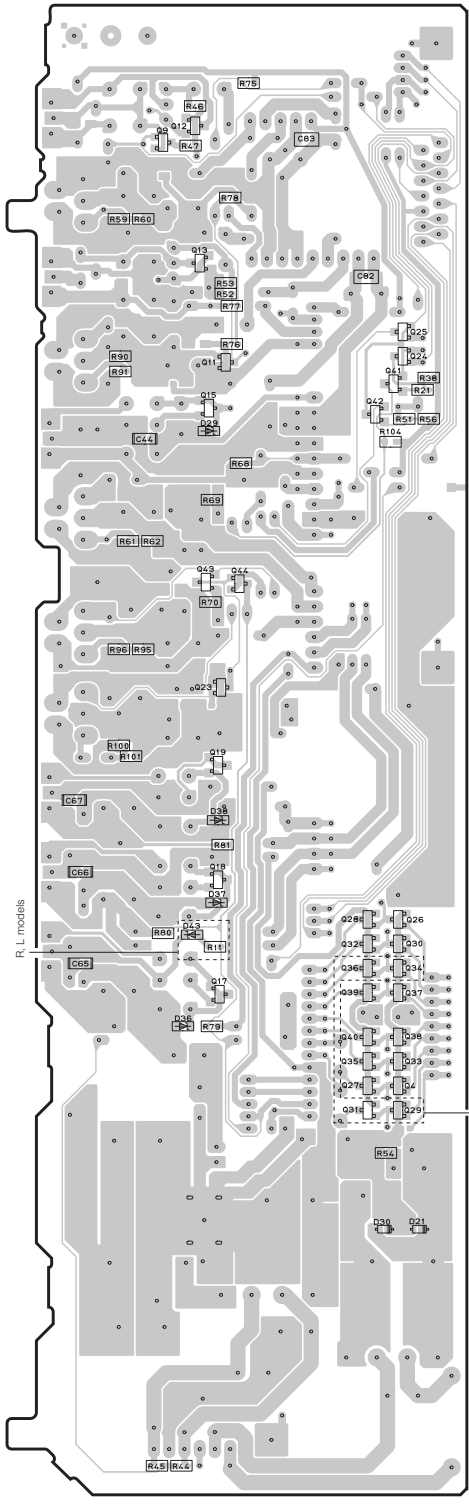

• Semiconductor Location

Ref no.	Location
D19	B3
D20	B3
D21	C7
D29	G6
D30	C7
D36	D6
D37	D6
D38	E2
D43	D6
IC4	F2
IC5	H2
IC6	G2
IC9	H2
IC10	G2
IC11	F2
IC12	E2
Q4	C7
Q9	H6
Q10	H2
Q11	G6
Q12	H6
Q13	G6
Q14	G2
Q15	G6
Q16	F2
Q17	D6
Q18	D6
Q19	E2
Q20	D2
Q21	D2
Q22	E2
Q23	E2
Q24	G7
Q25	G7
Q26	D7
Q27	C7
Q28	D7
Q29	C7
Q30	D7
Q31	C7
Q32	D7
Q33	C7
Q34	D7
Q35	C7
Q36	D7
Q37	D7
Q38	D7
Q39	D7
Q40	D7
Q41	G7
Q42	G7
Q43	F6
Q44	F6

A B C D E F G H I J

POWER (4) P.C.B. (Side A)

POWER (4) P.C.B. (Side B)

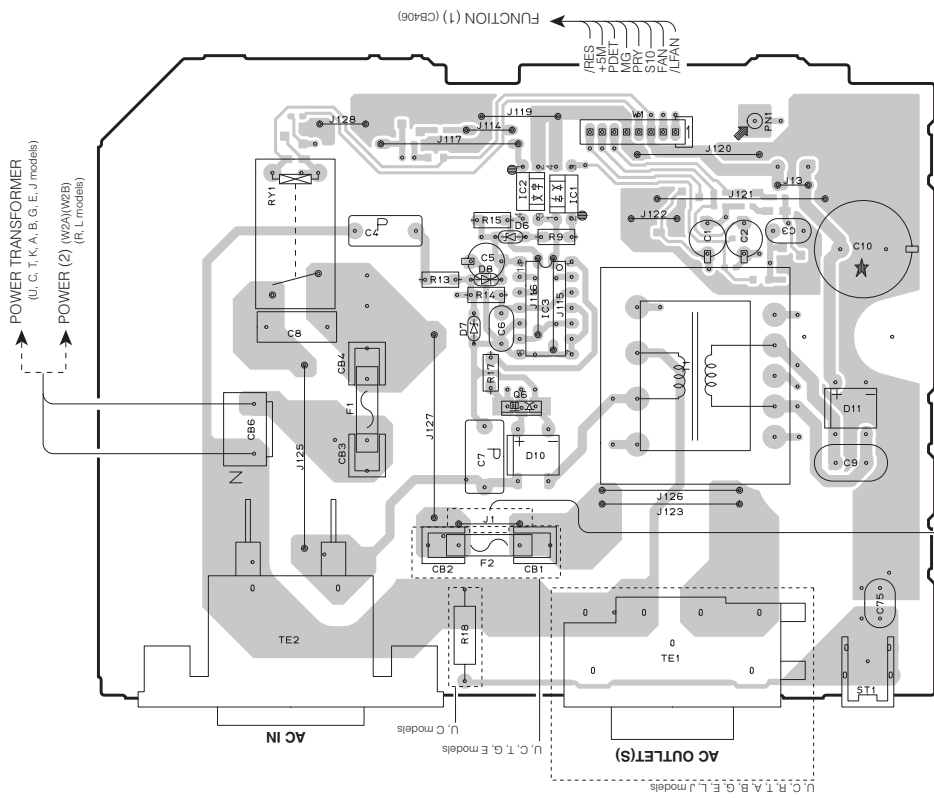

• Semiconductor Location

Ref.no.	Location
D1	H3
D2	H5
D3	H5
D4	H5
D5	H5
D6	D4
D7	C4
D8	C4
D9	H4
D10	C4
D11	C6
IC1	D4
IC2	D4
IC3	C4
Q1	H5
Q2	H3
C3	H5
C6	C4

A-VIDEO P.C.B. (Side A)

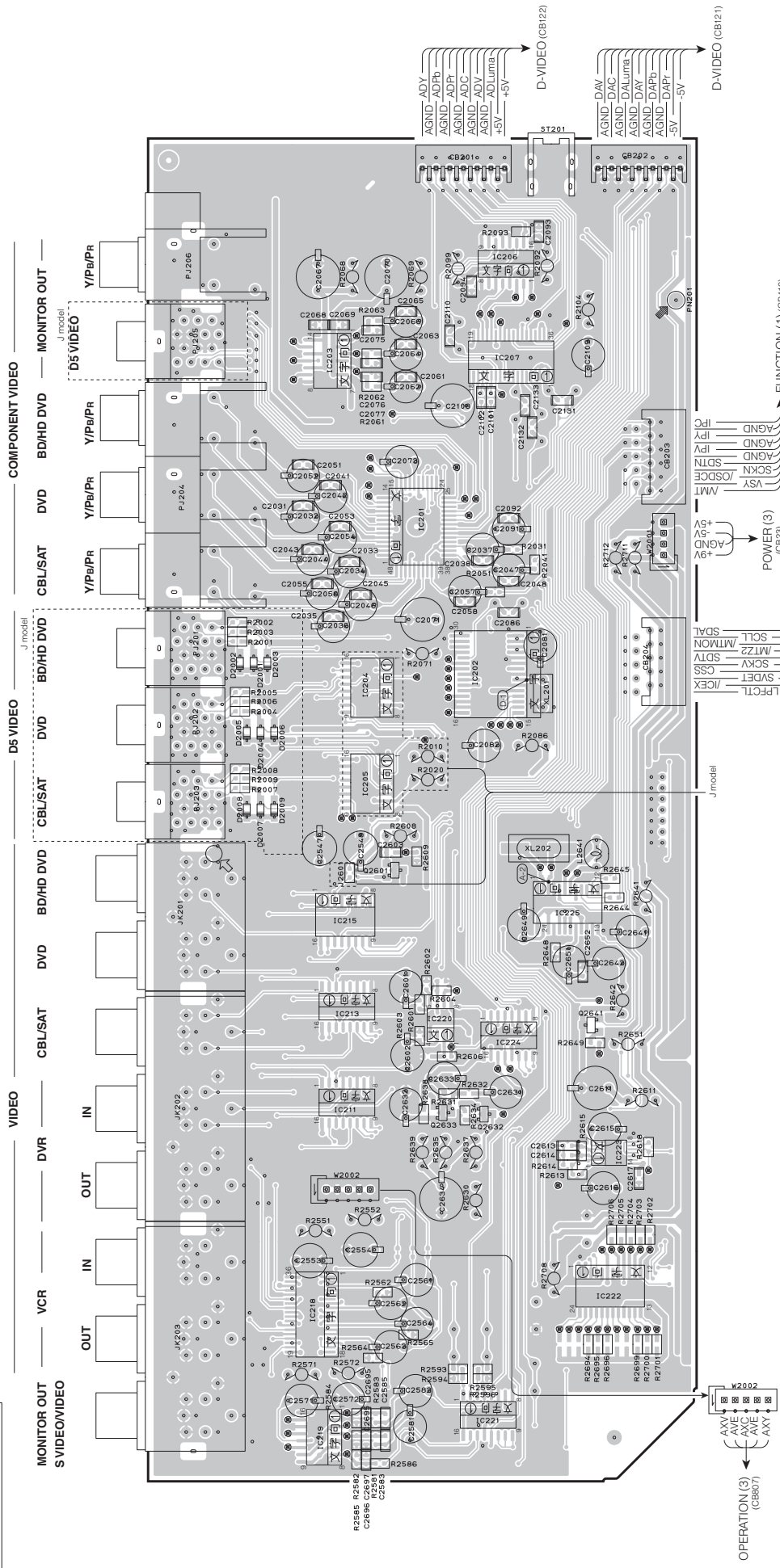

POINT (A) XL202 (Pin 3 of IC225)

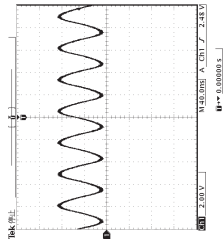

POINT (B) XL201 (Pin 9 of IC202)

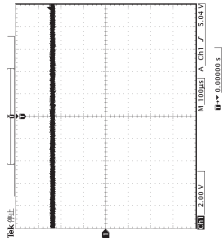

• Semiconductor Location

Ref no.	Location	Ref no.	Location	Ref no.	Location	Ref no.	Location
D2001	F3	D2008	F3	IC206	I4	IC220	D4
D2002	F3	D2009	F3	IC207	H4	IC221	B4
D2003	F3	IC201	G4	IC211	D3	IC222	C5
D2004	F3	IC202	F4	IC213	D3	IC223	D5
D2005	F3	IC203	H3	IC215	E3	IC224	D4
D2006	F3	IC204	F4	IC218	C3	IC225	E5
D2007	F3	IC205	F4	IC219	B3	Q2601	E4
						Q2632	D4
						Q2633	D4
						Q2634	D4
						Q2641	D5

A-VIDEO P.C.B. (Side B)

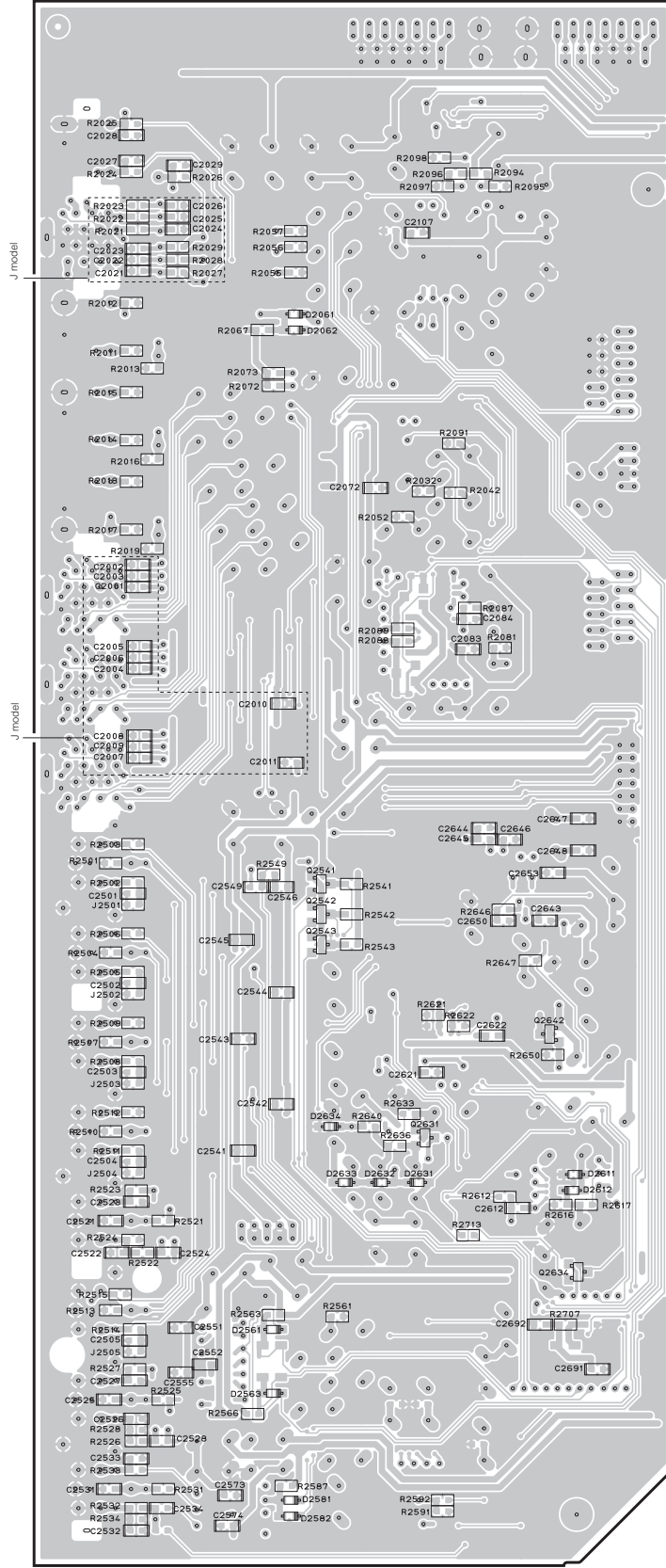

• Semiconductor Location

Ref. no.	Location	Ref. no.	Location	Ref. no.	Location
D2061	H4	D2582	B4	D2633	C4
D2062	H4	D2611	C5	D2634	D4
D2563	C3	D2612	C5	Q2541	E4
D2581	B4	D2631	C4	Q2542	E4
		D2632	C4	Q2543	E4
				Q2642	D5
				Q2643	D5

Circuit No.	U	C	R	T	K	A	B	G	E	L	J
C2501-2505							X				O
J2501-2505								O			X

X: NOT USED
O: USED/APPLICABLE

D-VIDEO P.C.B. (Side A)

Ref no.	Location	Ref no.	Location	Ref no.	Location
Q1006	I2	Q1805	C5	Q1811	B4
Q1007	H3	Q1806	C5	Q1812	B4
Q1801	B5	Q1807	C5	Q1813	G3
Q1802	B5	Q1808	B5		
Q1804	C5	Q1809	B4		

POWER (3) (W40)

A-VIDEO (CB201)

A-VIDEO (CB202)

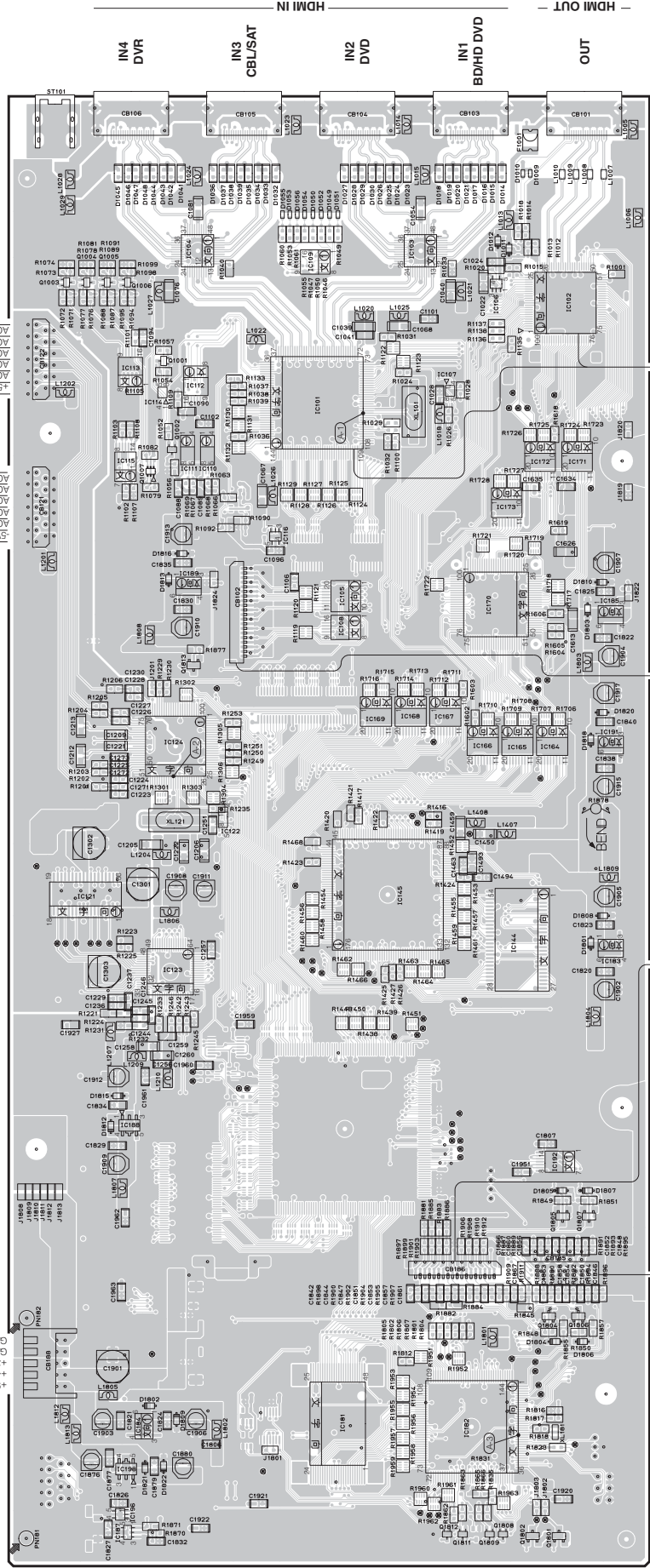

No replacement part available.
カービス部品供給なし

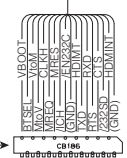
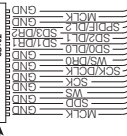

Ref no.	Location	Ref no.	Location	Ref no.	Location	Ref no.	Location
D1807	D5	IC105	G4	IC124	F3	IC183	E5
D1808	E5	IC106	I5	IC144	E5	IC184	B3
D1809	B3	IC107	H4	IC145	E4	IC185	B5
D1810	G5	IC108	G4	IC164	F5	IC187	G5
D1812	D2	IC109	I3	IC165	F5	IC188	D2
D1813	G3	IC110	H3	IC166	F4	IC189	G3
D1815	D2	IC111	H3	IC167	F4	IC191	F5
D1816	G3	IC112	H3	IC168	F4	IC192	D5
D1818	F4	IC113	H2	IC169	F4	IC196	B2
D1820	F5	IC114	H3	IC170	G4	IC198	B2
D1821	B3	IC115	H2	IC171	H5	Q1001	H3
D1822	B3	IC116	G3	IC172	H5	Q1002	H3
D1823	B3	IC121	H3	IC173	G5	Q1003	I2
D1825	C5	IC101	H3	IC174	F3	Q1004	I2
D1826	C5	IC103	I4	IC122	F2	Q1005	I2
D1827	C5	IC104	I3	IC123	E3		

Ref no.	Location	Ref no.	Location	Ref no.	Location	Ref no.	Location
D1009	I5	D1043	I3	D1053	I3	D1806	C5
D1010	I5	D1044	I3	D1054	I3	D1807	D5
D1011	I5	D1045	I2	D1055	I3	D1808	E5
D1012	I5	D1046	I2	D1056	I3	D1809	B3
D1014	I5	D1047	I2	D1801	E5	D1810	G5
D1015	I4	D1048	I3	D1802	B3	D1812	D2
D1016	I4	D1049	I4	D1803	G5	D1813	G3
D1017	I4	D1050	I3	D1804	C5	D1815	D2
D1018	I4	D1041	I3	D1805	I4	D1816	G3
D1019	I4	D1042	I3	D1806	C5	D1818	F4
D1020	I4	D1032	I3	D1807	D5	D1820	F5
D1021	I4	D1033	I3	D1808	E5	D1821	B3
D1022	I4	D1034	I3	D1809	B3	D1822	B3
D1023	I4	D1035	I3	D1810	G5	D1823	B3
D1024	I4	D1036	I3	D1811	H3	D1824	B3
D1025	I4	D1037	I3	D1812	D2	D1825	C5
D1026	I4	D1038	I4	D1813	G3	D1826	C5
D1027	I4	D1039	I3	D1814	H3	D1827	C5
D1028	I4	D1040	I4	D1815	D2	D1828	I4
D1029	I4	D1041	I3	D1816	G3	D1829	I4
D1030	I4	D1042	I3	D1817	H3	D1830	I4

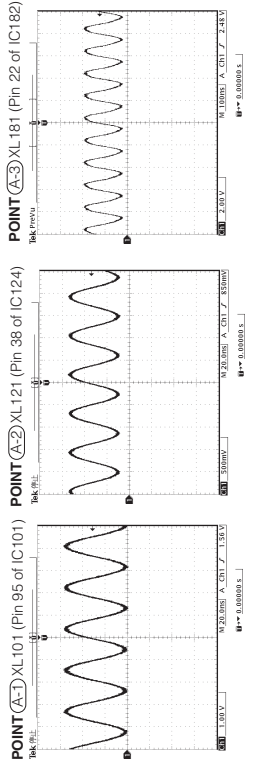

A B C D E F G H I J

D-VIDEO P.C.B. (Side B)

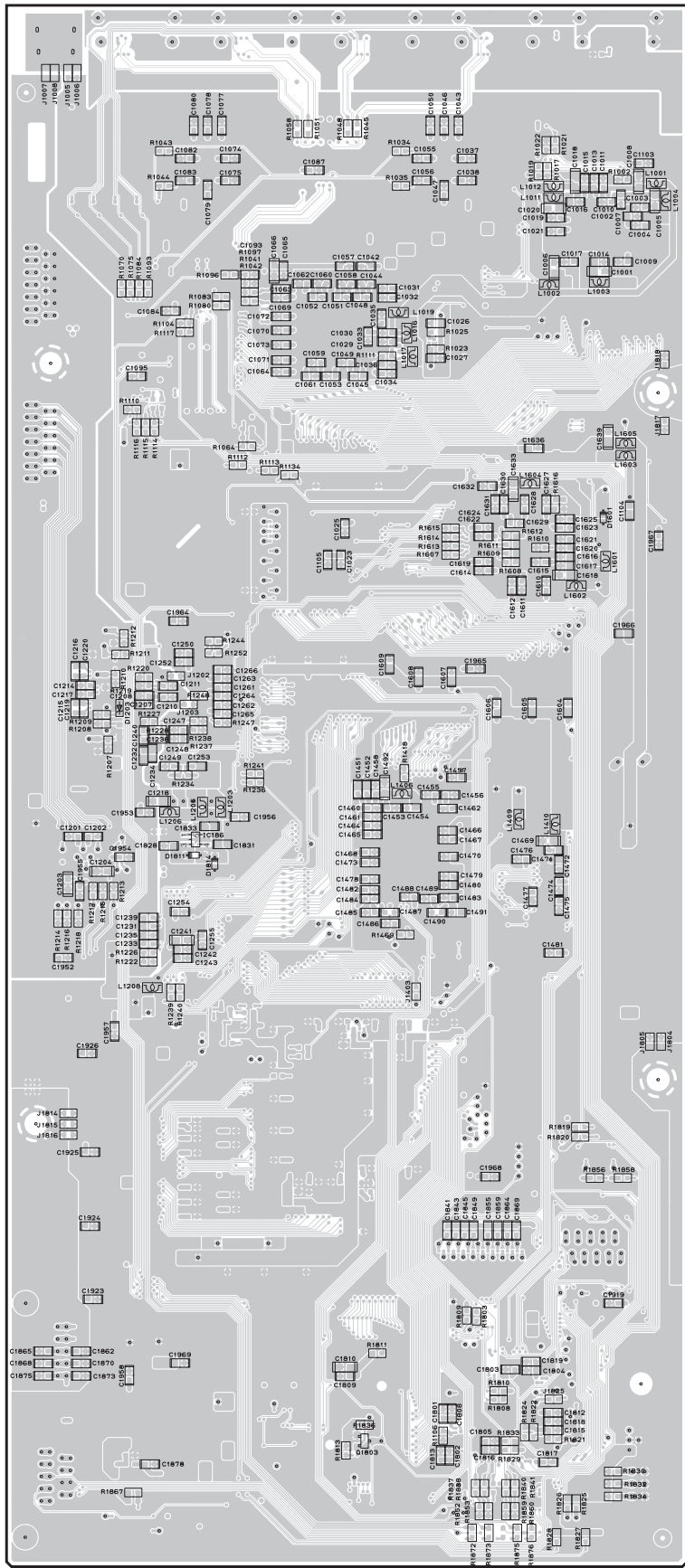

• Semiconductor Location

Ref. no.	Location
D1203	F2
D1801	G5
D1811	E3
D1814	E3
IC186	E3
IC1803	B3

RX-V1900/HTR-6290/DSP-AX1900

FL (1) P.C.B. (Side A)

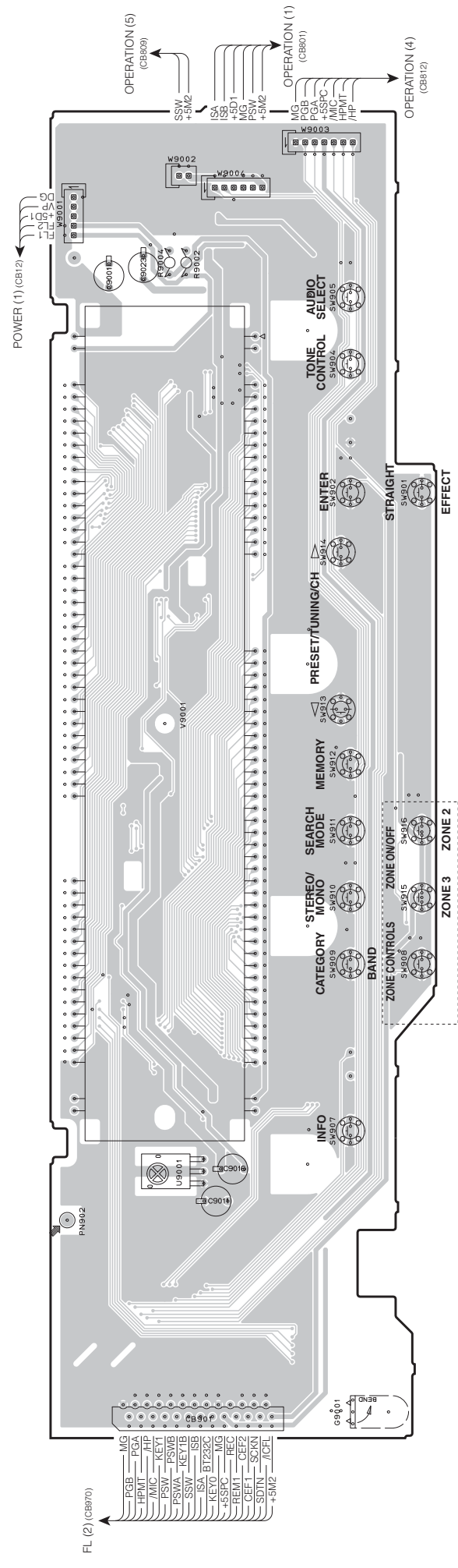

A B C D E F G H I J

FL (1) P.C.B. (Side B)

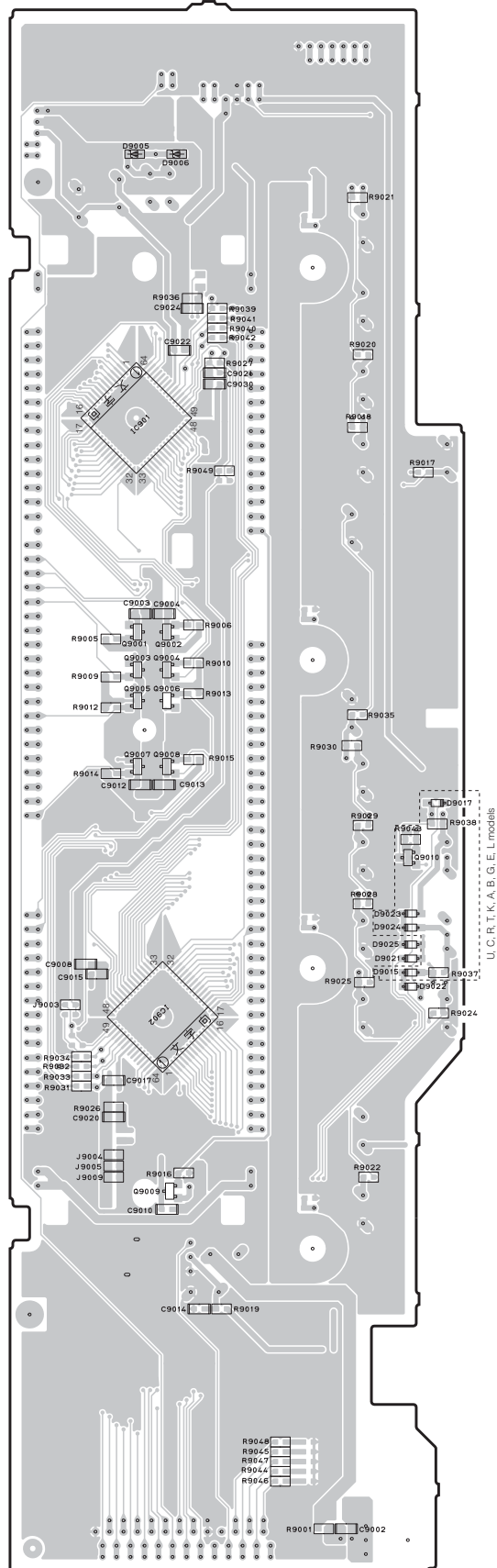

• Semiconductor Location

Ref no.	Location	Ref no.	Location
D9005	I3	C9001	F3
D9006	I3	C9002	F3
D9015	E4	C9003	F3
D9017	E5	C9004	F3
D9021	E4	C9005	F3
D9022	E4	C9006	F3
D9023	E4	C9007	F3
D9024	E4	C9008	F3
D9025	E4	C9009	C3
IC901	G3	C9010	E4
IC902	D3		

A

B

C

D

E

F

G

H

I

J

RX-V1900/HTR-6290/DSP-AX1900

FL (2) P.C.B. (Side B)

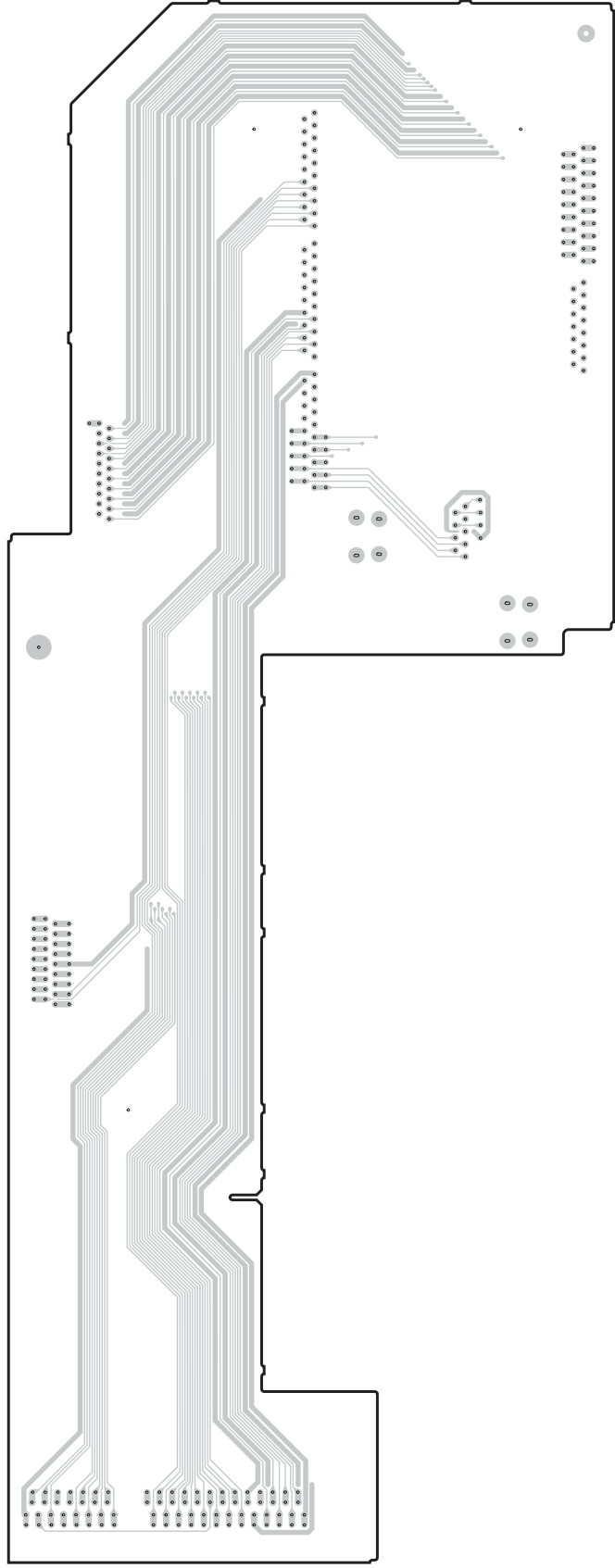

FL (3) P.C.B. (Side A)

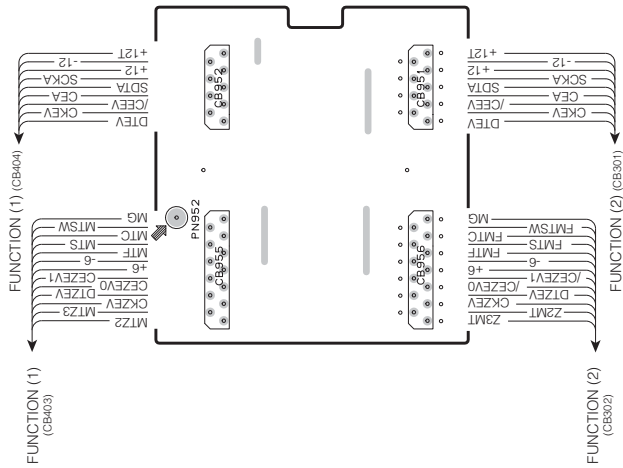

FL (3) P.C.B. (Side B)

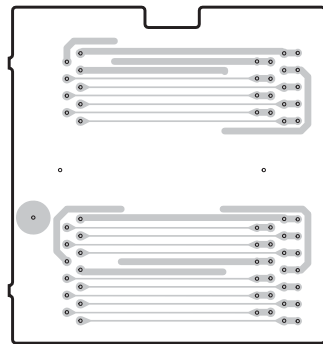

FL (4) P.C.B. (Side A)

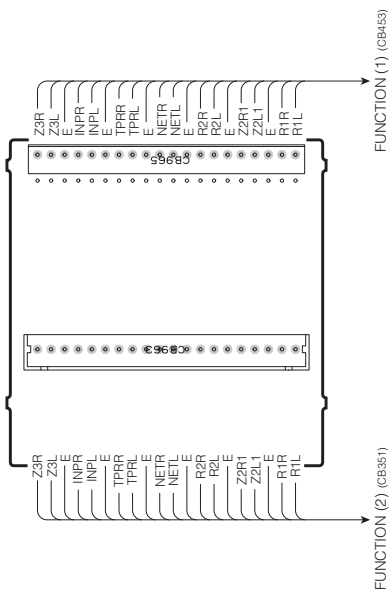

FL (4) P.C.B. (Side B)

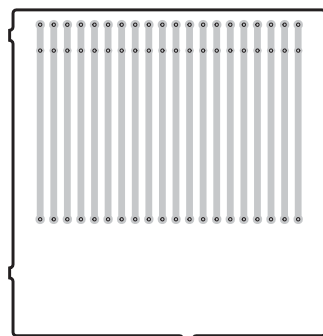

1

FL (5) P.C.B. (Side A)

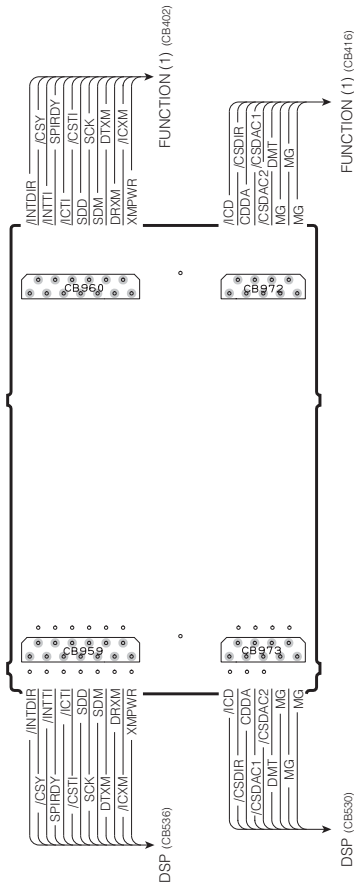

2

FL (6) P.C.B. (Side A)

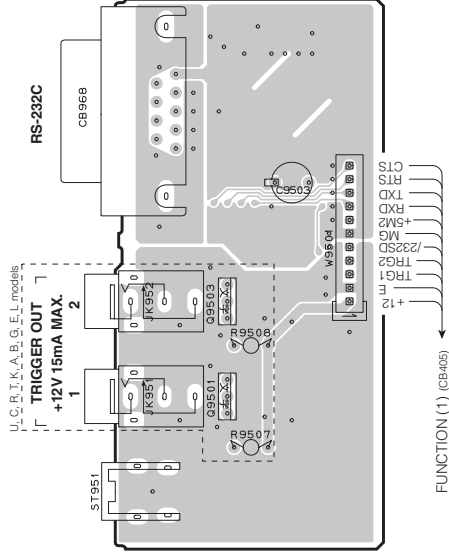

3

FL (5) P.C.B. (Side B)

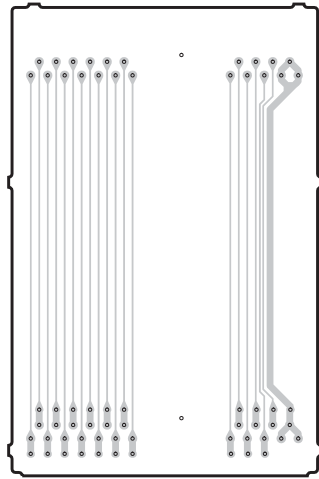

4

FL (6) P.C.B. (Side B)

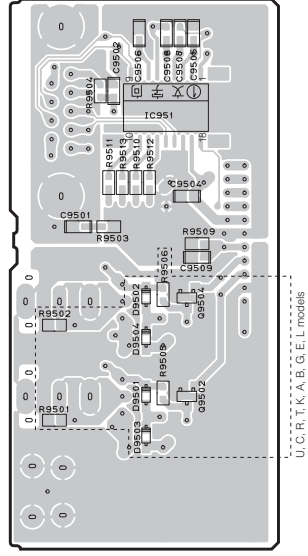

5

• Semiconductor Location

Ref no.	Location
D9501	G6
D9502	G6
D9503	G6
D9504	G6
IC951	H6
Q9501	G3
Q9502	G6
Q9503	G3
Q9504	G6

NET P.C.B. (Side A)

R, T, K, A, B, G, E, L, J models

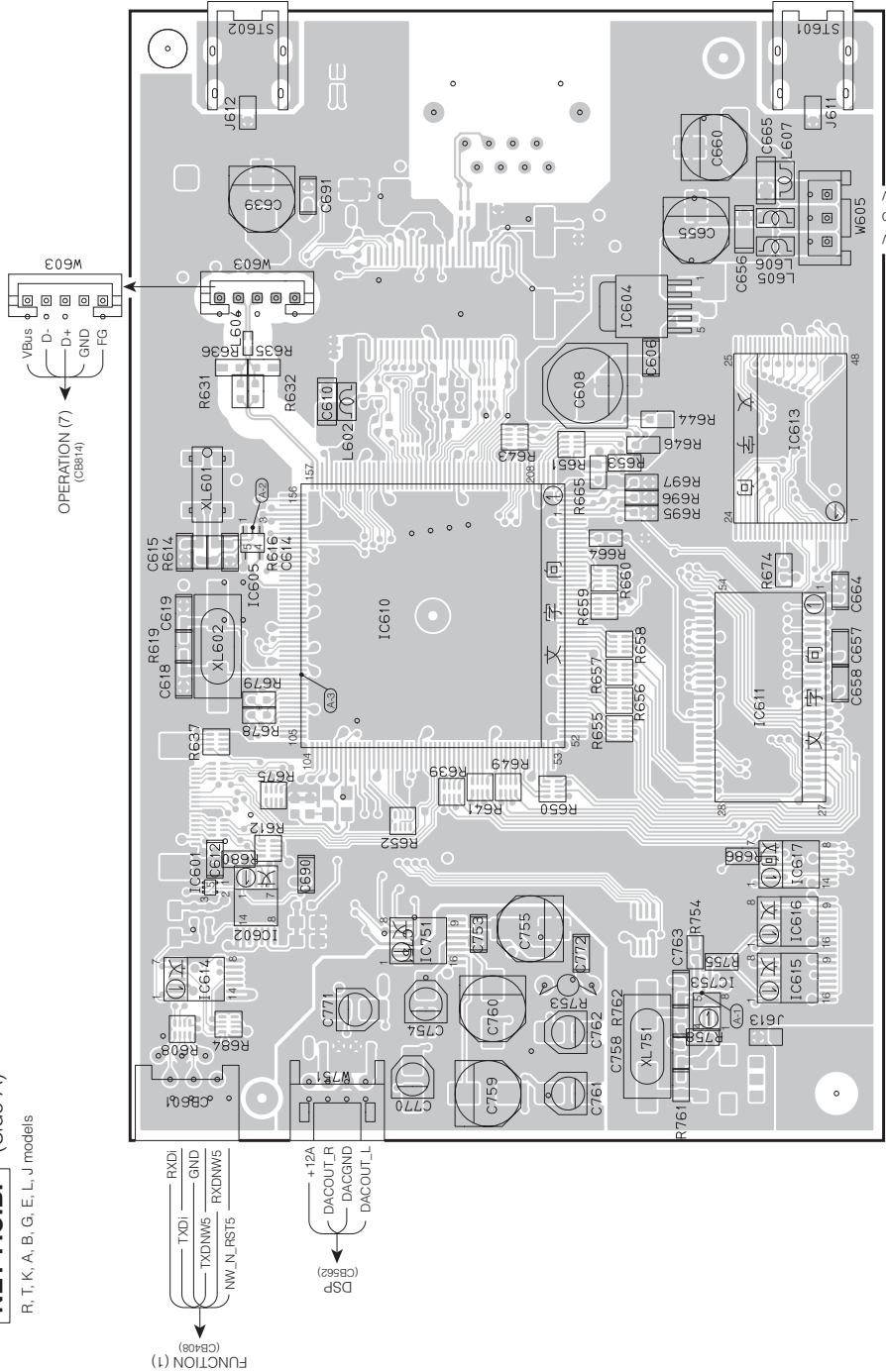

• Semiconductor Location

Ref. no.	Location
IC601	D2
IC602	D3
IC604	G4
IC605	F3
IC610	E3
IC611	E5
IC613	F5
IC614	E3
IC615	D5
IC616	D5
IC617	D5
IC751	D3
IC753	C5

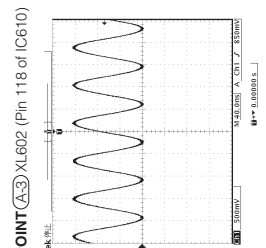
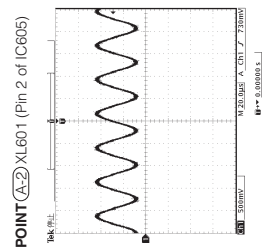
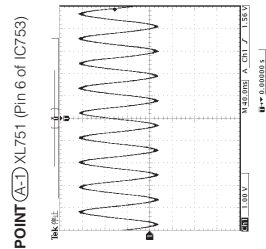

DSP (C6531)
+3.3V
GND
+5V

NET P.C.B. (Side B)

R, T, K, A, B, G, E, L, J models

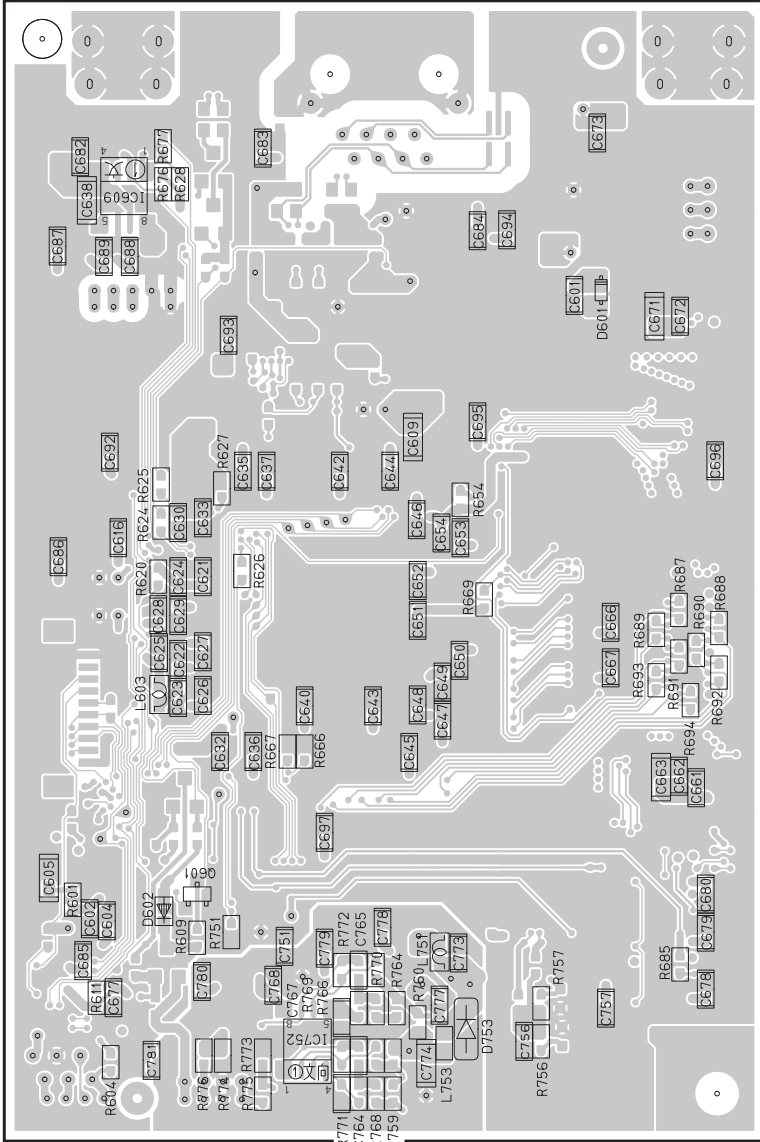

• Semiconductor Location

Ref. no.	Location
D601	G5
D602	D3
D763	C4
IC609	G3
IC752	C3
Q601	D3

A B C D E F G H I J

CONNECT (2) P.C.B. (Side A)

U, C models

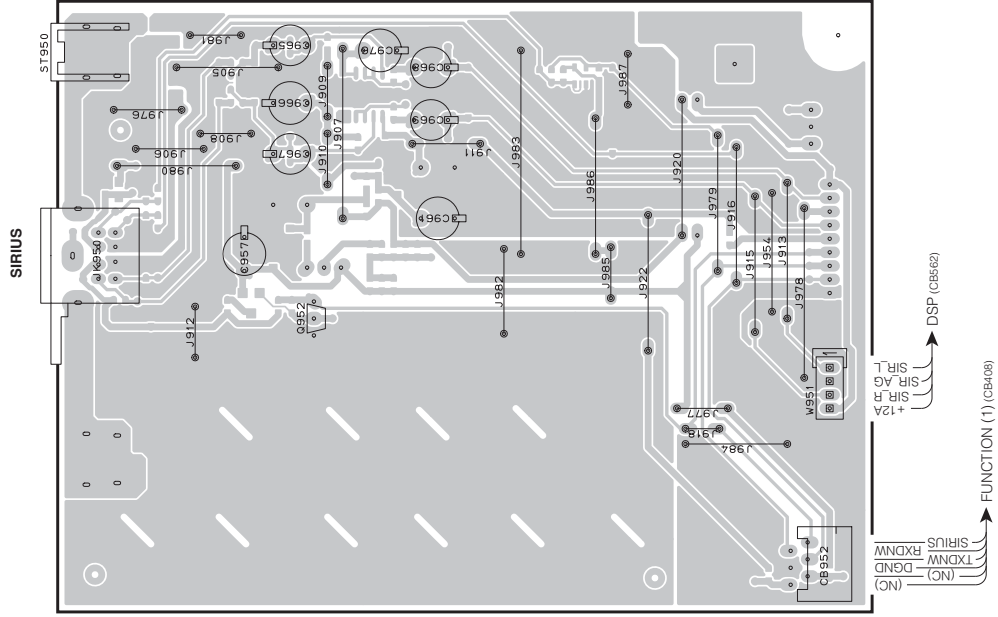

CONNECT (2) P.C.B. (Side B)

U, C models

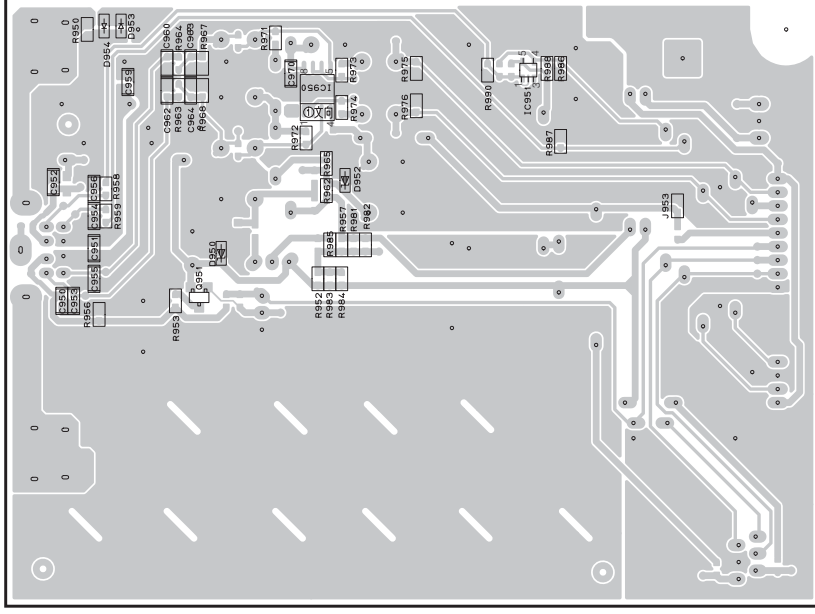

• Semiconductor Location



Ref. no.	Location
D950	G3
D952	H4
D953	I3
D954	I3
IC950	H4
IC951	H5
Q951	G3
Q952	C3

■ PIN CONNECTION DIAGRAMS

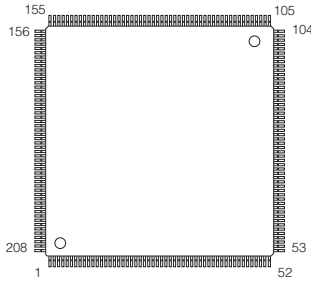
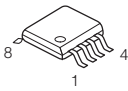
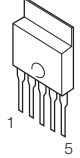

• ICs

ABT1010PQ100A 	ADM222ARZ 	ADV7342BSTZ 	ADV7401BSTZ-80 SI91934CTU
AK4384ET CD4051BNSR 	BA00JC5MT-V5 	BD3841FS 	CXB1442AR-T4
D70XE101BRFP266 M30845MW-001-GP M3087BF-KBGP 	BA15218F 	F2621E-01-TR YAC523-EVR2 	IP00C772
KIA7809AP1-LJP 	DSD1791DBR 	LA7106M-TLM-E MM74HC4051SUX MM74HC4053SUX PCM1781DBOR SN74CBT3253CPWR SN74LV163APWR 	LA73050-TLM-E LA73053-TLM-E LA73054-TLM-E
LC709004A-TLM-E LC72722PM LC74782JM-8A16-TLMC YAC526-EZE2 	KIA79M05P1-U 	LC69057M-VF4AD-E 	LM610IZ
NE5532DR 	NJM2068MD-TE2 	74LCX07MTCX NJM2581M SN74VHC14APWR TC74VHC108AFT TC74VHCU04FT 	NJM2867F3-05 TC7SET08FU TC7SET132FU TC7SET125FU
		M24CO2-WD6T6P 	NJM2865DL1-33

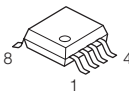
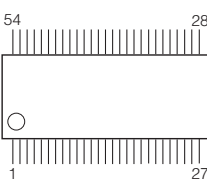



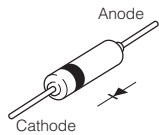
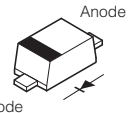
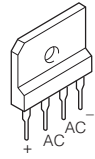
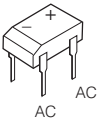
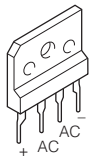
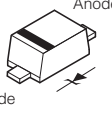
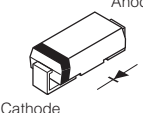
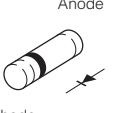
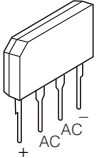



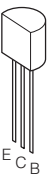

NJM4565M SN74LVC2G125DCUR 	NJU7311AM NJU7312AM NJU7313AM 	NJU7119AV 	NJM1321FP1
PCM1804DBR 	PQ200MNA1ZPH 	PT6302LQ-008 	R1131N181D R3112N421A-TR-F SN74LVC1GU04DCKR TC7SH00FU TC7SH08FU
R1171S181B-E2-F R1171TS331B-E2-F R1172S121D-E2-F R1172S181B-E2-F R1172S331B-E2-F 	RH5RES8AA-T1-FA 	MX29LV32CBTC-90G S29AL004D70TF1020 S29AL016D70TF1020 	SI-8008HFE
SN74AHC100PWR 	SN74AHC108PWR SN74LV32APWR SN74LV74APWR TC74VHC125FT 	SN74CBT3257CPWR 	SN74LV157APWR TC74VHC153FT TC74VHC157FT
SN74LV245APWR 	SN74LV245APWR SN74LVTH245APW 	SN74LVC3GU04DCTR 	SI9135CTU
TA1318AF 	TC4013BP 	TC74HC4052AF 	TC7WZ09FK TC7WZ04FK

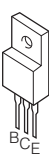
<p>EP9301-CQZ</p> 	<p>MIC2026-2BM</p> 	<p>PQ018EZ01ZP</p> 	<p>SN74AHC1G08DCKR SN74AHCT1G32DCKR</p> 	<p>TK15420M</p> 
<p>K4S281632K-UC75000 W9864G6GH-7</p> 				

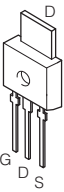
• Diodes

<p>1N4002S 1SS133,176 HZS242TD MTZJ10B MTZJ5.1C MTZJ6.8B</p> 	<p>1SS355 1SS380 MA732 MA8030-L MA8039-H MA8043-L MA8047 MA8047-L MA8051-M MA8062-M MA8068-M</p>	<p>MA8075-M MA8130-M MA8240-M MA8300-L RB501V-40 UDZS5.6BTE-17</p> 	
<p>D15XBN20</p> 	<p>DB105</p> 	<p>KRS440M-B-C-J80</p> 	<p>MA8024-(TX) 2.4V</p> 
<p>RB051L-40</p> 	<p>RLS245</p> 	<p>RS203M-B-C-J80</p> 	<p>RLZ5.1A 5.1V</p> 

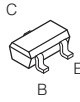
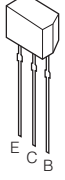
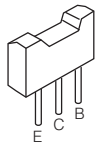
• Transistors

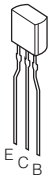
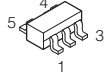
<p>2SA949 2SC1815 2SC2229 2SC2878</p> 	<p>2SA2168 2SC5291</p> 	<p>2SB1257 2SB1274 2SC3852 2SD2014</p> 	<p>A2151/C6011</p> 	<p>μPA672T-T1-A</p> <ol style="list-style-type: none"> Source 1 (S1) Gate 1 (G1) Drain 2 (D2) Source 2 (S2) Gate 2 (G2) Drain 1 (D1) 	<p>2SK3850</p> 
<p>2SA1036KT146 2SA1037K 2SC2412K 2SC3326 2SC3878K 2SC3906K 2SC4081 2SD1938F</p> 	<p>2SK208 5HP01C-TB-E</p> 	<p>DTC114EKA DTC144EKA</p>  <p>1: GND 2: IN 3: OUT</p>	<p>KRA102S-RTK/P KRA104S-RTK KRC102S-RTK KRC104S-RTK</p> 	<p>KTA1504S KTA1517S KTC3875S KTC3911S</p> 	
<p>KRC102M-AT</p> 	<p>2SA1708 2SC4488</p> 	<p>3LN01C-TB-E</p> 	<p>2SD1915F</p> 	<p>HN4C06J</p>  <ol style="list-style-type: none"> BASE 1 (B1) EMITTER (E) BASE 2 (B2) COLLECTOR 2 (C2) COLLECTOR 1 (G2) 	

RX-V1900/HTR-6290/
DSP-AX1900

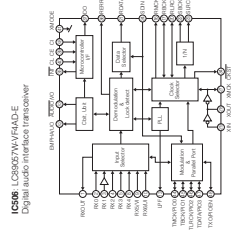
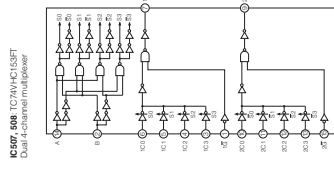
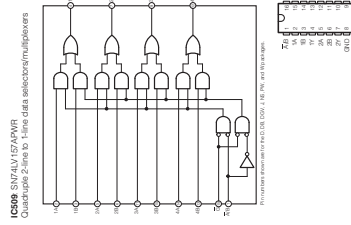
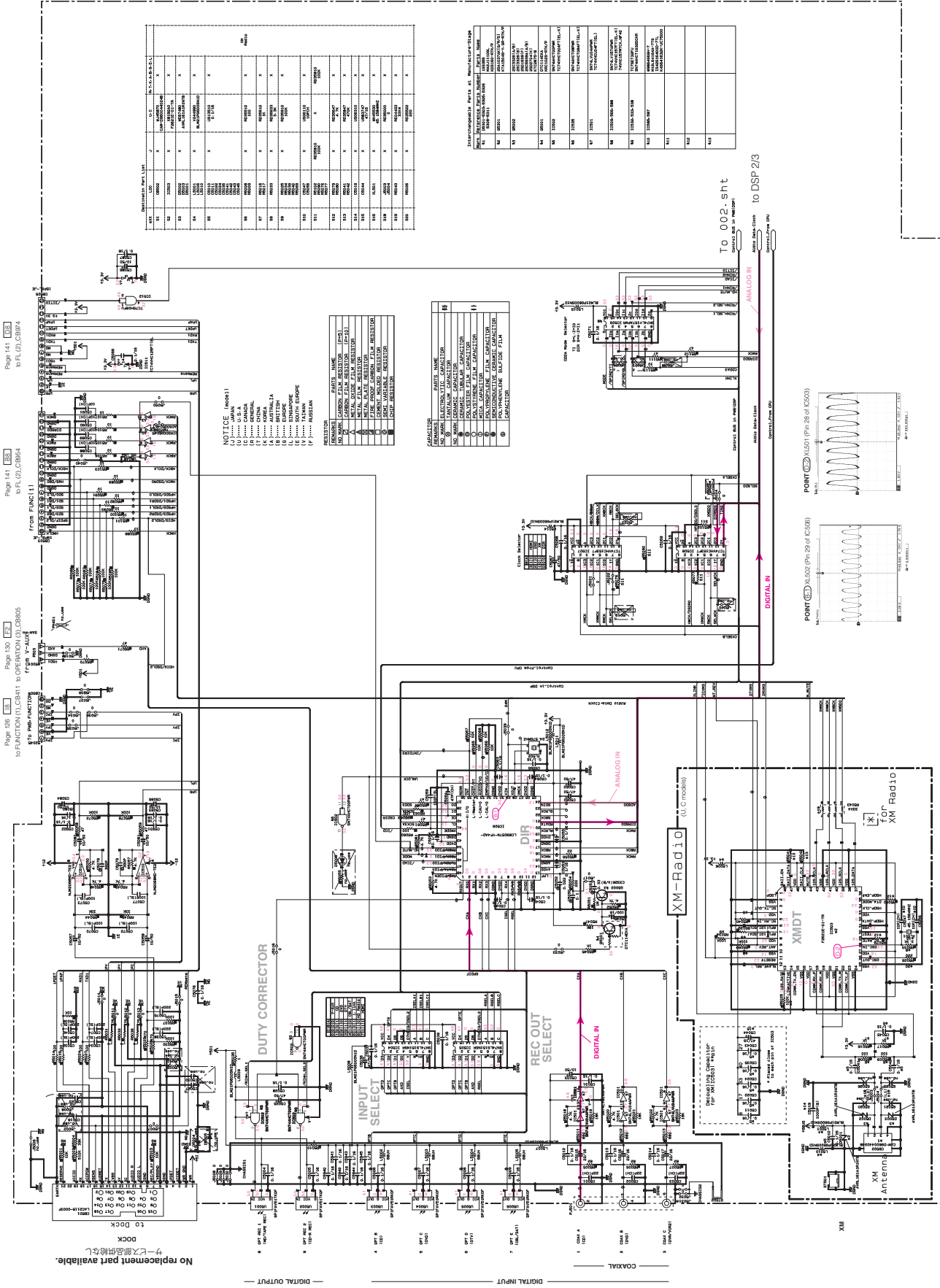

RESISTOR	VALUE	TYPE	RESISTOR	VALUE	TYPE
R1	10k	1%	R10	10k	1%
R2	10k	1%	R11	10k	1%
R3	10k	1%	R12	10k	1%
R4	10k	1%	R13	10k	1%
R5	10k	1%	R14	10k	1%
R6	10k	1%	R15	10k	1%
R7	10k	1%	R16	10k	1%
R8	10k	1%	R17	10k	1%
R9	10k	1%	R18	10k	1%
R19	10k	1%	R19	10k	1%

CAPACITOR	VALUE	TYPE	CAPACITOR	VALUE	TYPE
C1	100n	1%	C10	100n	1%
C2	100n	1%	C11	100n	1%
C3	100n	1%	C12	100n	1%
C4	100n	1%	C13	100n	1%
C5	100n	1%	C14	100n	1%
C6	100n	1%	C15	100n	1%
C7	100n	1%	C16	100n	1%
C8	100n	1%	C17	100n	1%
C9	100n	1%	C18	100n	1%
C19	100n	1%	C19	100n	1%

- * AI voltages are measured with a 10MΩV DC electronic voltmeter. Measurement points are indicated by * with parts having specifications equal to those originally installed.
- * Schematic diagram is subject to change without notice.
- 電圧は、内阻低阻 (10MΩ) の電圧計で測定したものです。測定点の交換は必ず慎重に行ってください。
- 1. 目的のある部品は、必ず仕様等が一致するようにしてください。部品の交換が必須な場合は、本回路図は最新回路図です。改訂のため予告なく変更することがあります。

Page 141 IC509

Page 141 IC507, 508

Page 142 IC504, 505

Page 143 IC501, 502

Page 144 IC510, 511

Page 145 IC514, 515, 516

No replacement part available.
予て交換部品なし

DIGITAL OUTPUT

DIGITAL INPUT

COAXIAL

TO DOCK

FROM V-AMP

FROM V-AMP

FROM V-AMP

FROM V-AMP

FROM V-AMP

FROM V-AMP

FROM V-AMP

FROM V-AMP

FROM V-AMP

FROM V-AMP

FROM V-AMP

FROM V-AMP

FROM V-AMP

FROM V-AMP

FROM V-AMP

FROM V-AMP

FROM V-AMP

FROM V-AMP

FROM V-AMP

FROM V-AMP

FROM V-AMP

To 002 sht
CONTACT REF. # 002

To 002 sht
CONTACT REF. # 002

FROM V-AMP

FROM V-AMP

FROM V-AMP

FROM V-AMP

FROM V-AMP

FROM V-AMP

FROM V-AMP

FROM V-AMP

FROM V-AMP

FROM V-AMP

FROM V-AMP

FROM V-AMP

FROM V-AMP

FROM V-AMP

FROM V-AMP

FROM V-AMP

FROM V-AMP

FROM V-AMP

FROM V-AMP

FROM V-AMP

FROM V-AMP

FROM V-AMP

FROM V-AMP

FROM V-AMP

FROM V-AMP

FROM V-AMP

FROM V-AMP

FROM V-AMP

FROM V-AMP

FROM V-AMP

FROM V-AMP

FROM V-AMP

FROM V-AMP

FROM V-AMP

FROM V-AMP

FROM V-AMP

FROM V-AMP

FROM V-AMP

FROM V-AMP

FROM V-AMP

FROM V-AMP

FROM V-AMP

FROM V-AMP

FROM V-AMP

FROM V-AMP

FROM V-AMP

FROM V-AMP

Page 143 142
IC NET W51 (G) (NET W51) (G) (E.L.I.) (J) (code)

Page 129 128
IC FUNCTION (2) (C) (8000)

Page 114 113
IC FUNCTION (2) (W) (500)

Page 114 113
IC FUNCTION (2) (W) (501)

Page 114 113
IC FUNCTION (2) (W) (501)

RESISTOR

1	100Ω
2	100Ω
3	100Ω
4	100Ω
5	100Ω
6	100Ω
7	100Ω
8	100Ω
9	100Ω
10	100Ω

NET LIST (POST)

(1)	U.S.A.
(2)	U.S.A.
(3)	U.S.A.
(4)	U.S.A.
(5)	U.S.A.
(6)	U.S.A.
(7)	U.S.A.
(8)	U.S.A.
(9)	U.S.A.
(10)	U.S.A.

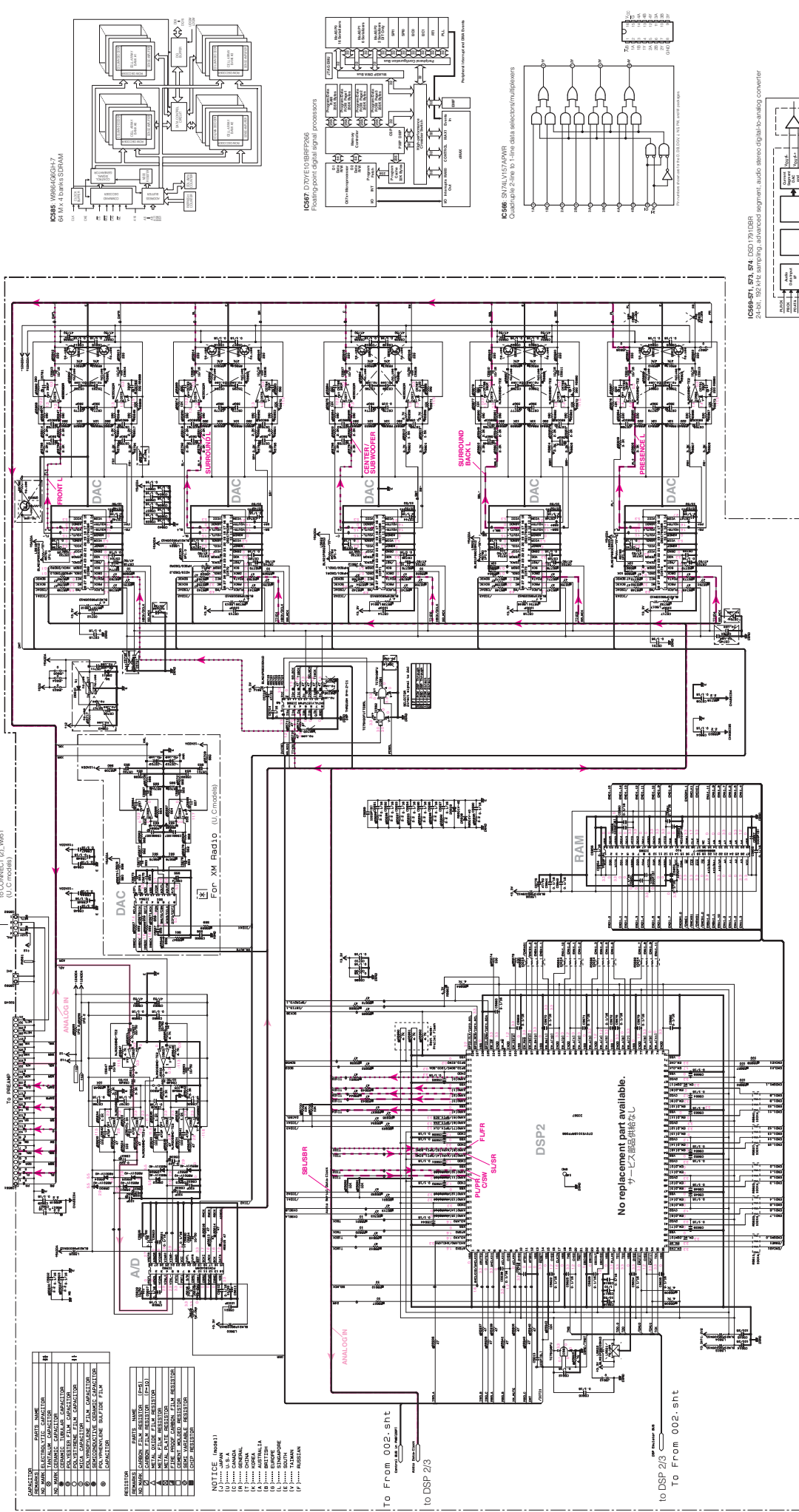

IC566: W8864GBH-7
64 M/A-4 BANKS SDRAM

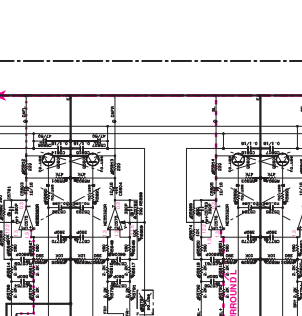

IC567: D7310
Floating-point signal processors

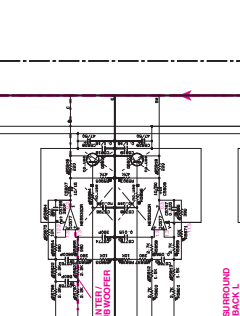

IC568: S241V12APWR
Quad-line 2-line to 1-line data selectors/multiplexers

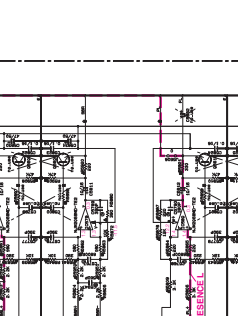

IC569: S71_674_674
24-bit, 192 kHz sampling, advanced segment, audio stereo digital-to-analog converter

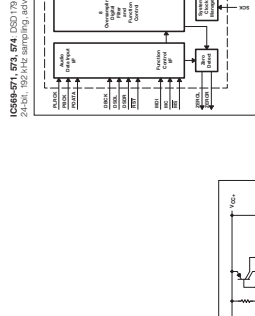

IC566: 675-577
Dual low-noise operational amplifiers

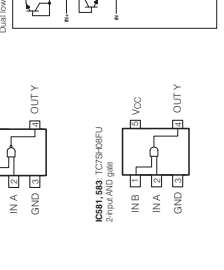

IC565: 1C530 (K70)
2-input AND gate

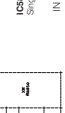

IC561: 581
2-input AND gate



IC564: AK4384ET
D/A converter



IC568: S65_576_580
Dual operational amplifier



IC568: S65_576_580
Stereo AD converter



IC564: AK4384ET
D/A converter



IC568: S65_576_580
Dual operational amplifier

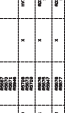

IC564: AK4384ET
D/A converter



IC568: S65_576_580
Dual operational amplifier

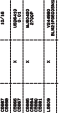

IC564: AK4384ET
D/A converter

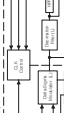

IC568: S65_576_580
Dual operational amplifier

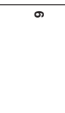

IC564: AK4384ET
D/A converter



No replacement part available.
カービシ部品供給なし

- * AI voltages are measured with a 10MΩV DC electronic voltmeter.
- * Components having special characteristics are marked * and must be replaced with special components.
- * Schematic diagram is subject to change without notice.
- 電圧は、10MΩVの電圧計で測定したものです。
- 1: 目的のある部品は、特殊な特長を示しています。部品の交換が重要で、必ず特殊部品を交換してください。
- 本回路図は仕様図です。改訂のため予告なく変更することがあります。

FUNCTION 1/4

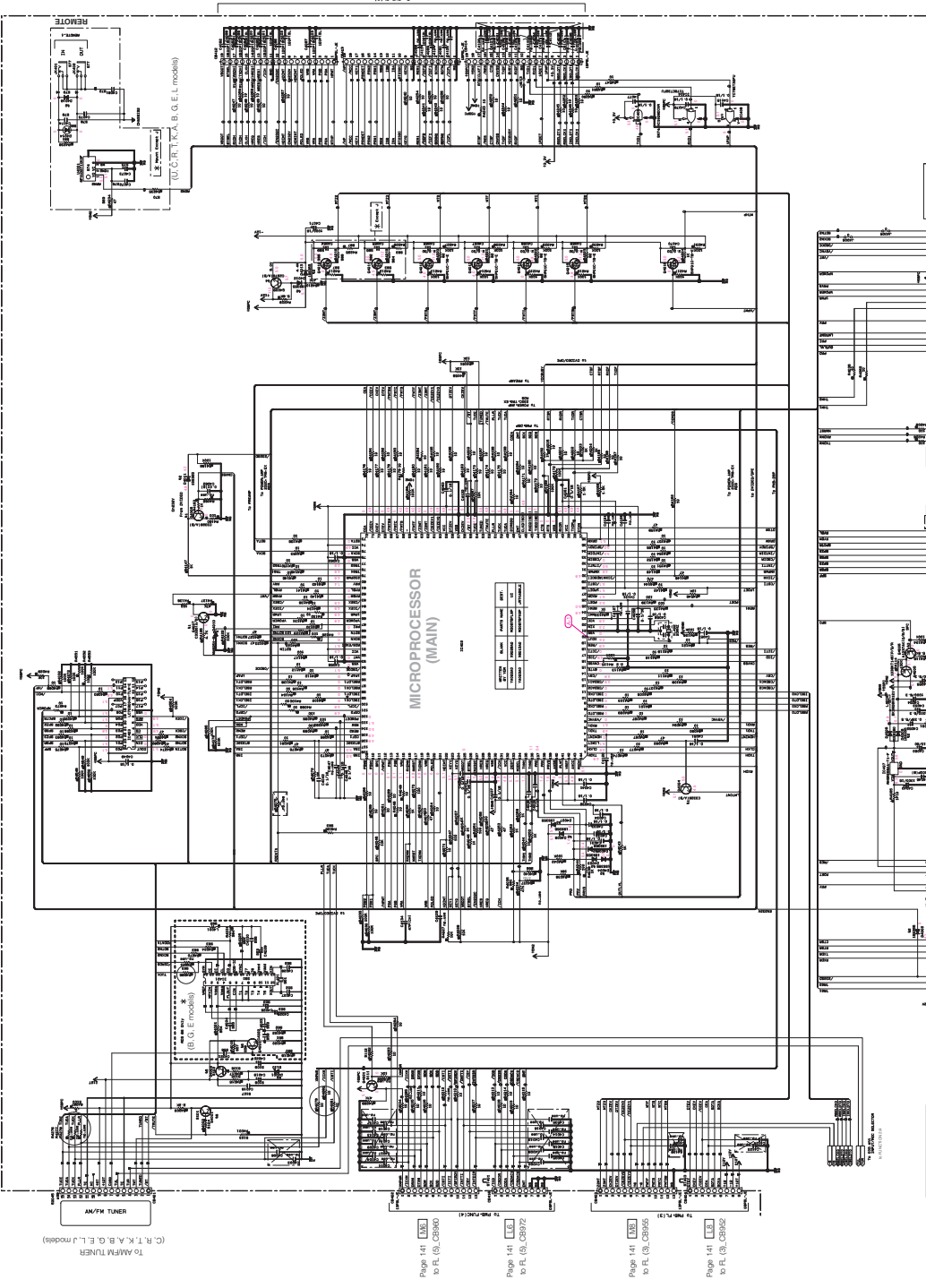

IC NO.	IC NAME	MANUFACTURER	REMARKS
101	IC101	DAIICHI ELECTRONIC INDUSTRIES	VIDEO DECODER
102	IC102	DAIICHI ELECTRONIC INDUSTRIES	VIDEO DECODER
103	IC103	DAIICHI ELECTRONIC INDUSTRIES	VIDEO DECODER
104	IC104	DAIICHI ELECTRONIC INDUSTRIES	VIDEO DECODER
105	IC105	DAIICHI ELECTRONIC INDUSTRIES	VIDEO DECODER
106	IC106	DAIICHI ELECTRONIC INDUSTRIES	VIDEO DECODER
107	IC107	DAIICHI ELECTRONIC INDUSTRIES	VIDEO DECODER
108	IC108	DAIICHI ELECTRONIC INDUSTRIES	VIDEO DECODER
109	IC109	DAIICHI ELECTRONIC INDUSTRIES	VIDEO DECODER
110	IC110	DAIICHI ELECTRONIC INDUSTRIES	VIDEO DECODER
111	IC111	DAIICHI ELECTRONIC INDUSTRIES	VIDEO DECODER
112	IC112	DAIICHI ELECTRONIC INDUSTRIES	VIDEO DECODER
113	IC113	DAIICHI ELECTRONIC INDUSTRIES	VIDEO DECODER
114	IC114	DAIICHI ELECTRONIC INDUSTRIES	VIDEO DECODER
115	IC115	DAIICHI ELECTRONIC INDUSTRIES	VIDEO DECODER
116	IC116	DAIICHI ELECTRONIC INDUSTRIES	VIDEO DECODER
117	IC117	DAIICHI ELECTRONIC INDUSTRIES	VIDEO DECODER
118	IC118	DAIICHI ELECTRONIC INDUSTRIES	VIDEO DECODER
119	IC119	DAIICHI ELECTRONIC INDUSTRIES	VIDEO DECODER
120	IC120	DAIICHI ELECTRONIC INDUSTRIES	VIDEO DECODER
121	IC121	DAIICHI ELECTRONIC INDUSTRIES	VIDEO DECODER
122	IC122	DAIICHI ELECTRONIC INDUSTRIES	VIDEO DECODER
123	IC123	DAIICHI ELECTRONIC INDUSTRIES	VIDEO DECODER
124	IC124	DAIICHI ELECTRONIC INDUSTRIES	VIDEO DECODER
125	IC125	DAIICHI ELECTRONIC INDUSTRIES	VIDEO DECODER
126	IC126	DAIICHI ELECTRONIC INDUSTRIES	VIDEO DECODER
127	IC127	DAIICHI ELECTRONIC INDUSTRIES	VIDEO DECODER
128	IC128	DAIICHI ELECTRONIC INDUSTRIES	VIDEO DECODER
129	IC129	DAIICHI ELECTRONIC INDUSTRIES	VIDEO DECODER
130	IC130	DAIICHI ELECTRONIC INDUSTRIES	VIDEO DECODER
131	IC131	DAIICHI ELECTRONIC INDUSTRIES	VIDEO DECODER
132	IC132	DAIICHI ELECTRONIC INDUSTRIES	VIDEO DECODER
133	IC133	DAIICHI ELECTRONIC INDUSTRIES	VIDEO DECODER
134	IC134	DAIICHI ELECTRONIC INDUSTRIES	VIDEO DECODER
135	IC135	DAIICHI ELECTRONIC INDUSTRIES	VIDEO DECODER
136	IC136	DAIICHI ELECTRONIC INDUSTRIES	VIDEO DECODER
137	IC137	DAIICHI ELECTRONIC INDUSTRIES	VIDEO DECODER
138	IC138	DAIICHI ELECTRONIC INDUSTRIES	VIDEO DECODER
139	IC139	DAIICHI ELECTRONIC INDUSTRIES	VIDEO DECODER
140	IC140	DAIICHI ELECTRONIC INDUSTRIES	VIDEO DECODER
141	IC141	DAIICHI ELECTRONIC INDUSTRIES	VIDEO DECODER
142	IC142	DAIICHI ELECTRONIC INDUSTRIES	VIDEO DECODER
143	IC143	DAIICHI ELECTRONIC INDUSTRIES	VIDEO DECODER
144	IC144	DAIICHI ELECTRONIC INDUSTRIES	VIDEO DECODER
145	IC145	DAIICHI ELECTRONIC INDUSTRIES	VIDEO DECODER
146	IC146	DAIICHI ELECTRONIC INDUSTRIES	VIDEO DECODER
147	IC147	DAIICHI ELECTRONIC INDUSTRIES	VIDEO DECODER
148	IC148	DAIICHI ELECTRONIC INDUSTRIES	VIDEO DECODER
149	IC149	DAIICHI ELECTRONIC INDUSTRIES	VIDEO DECODER
150	IC150	DAIICHI ELECTRONIC INDUSTRIES	VIDEO DECODER

NOTICE (Main1)

1. THE IC NUMBER IS INDICATED BY THE MARKING ON THE IC PACKAGE.

2. THE IC NUMBER IS INDICATED BY THE MARKING ON THE IC PACKAGE.

3. THE IC NUMBER IS INDICATED BY THE MARKING ON THE IC PACKAGE.

4. THE IC NUMBER IS INDICATED BY THE MARKING ON THE IC PACKAGE.

5. THE IC NUMBER IS INDICATED BY THE MARKING ON THE IC PACKAGE.

6. THE IC NUMBER IS INDICATED BY THE MARKING ON THE IC PACKAGE.

7. THE IC NUMBER IS INDICATED BY THE MARKING ON THE IC PACKAGE.

8. THE IC NUMBER IS INDICATED BY THE MARKING ON THE IC PACKAGE.

9. THE IC NUMBER IS INDICATED BY THE MARKING ON THE IC PACKAGE.

10. THE IC NUMBER IS INDICATED BY THE MARKING ON THE IC PACKAGE.

FUNCTION (1)

RX-V1900

FUNC. (1)

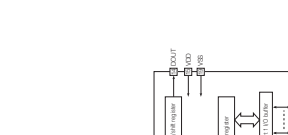
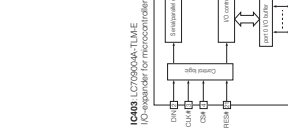
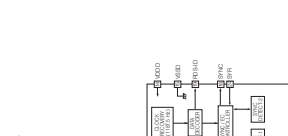
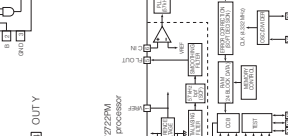
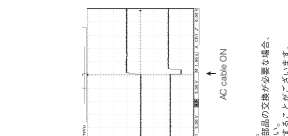
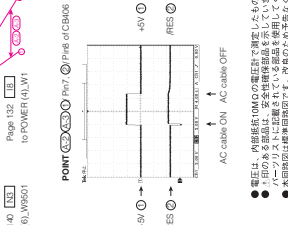
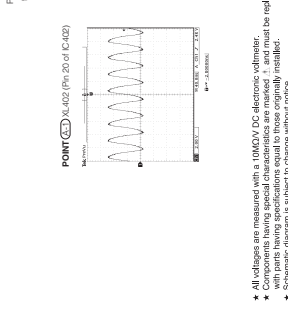

* All values are measured with a 1MHz/100pF electronic calibrator.
 * Components having special characteristics are marked L and must be realized with parts having specifications equal to those originally installed.
 * Schematic diagram is subject to change without notice.

REMARKS	PARTS NAME
NO MARK	CARBON FILM RESISTOR (P=5)
△	CARBON FILM RESISTOR (P=10)
▲	METAL OXIDE FILM RESISTOR
△	METAL FILM RESISTOR
⊖	METAL PLATE RESISTOR
□	CHMENT MOLDED RESISTOR
□	SEMICONDUCTIVE CERAMIC CAPACITOR
●	CHIP RESISTOR

REMARKS	PARTS NAME
NO MARK	ELECTROLYTIC CAPACITOR
⊗	TANTALUM CAPACITOR
⊙	CERAMIC CAPACITOR
⊙	CERAMIC TUBULAR CAPACITOR
⊙	POLYESTER FILM CAPACITOR
⊙	POLYETHYLENE FILM CAPACITOR
⊙	POLYPROPYLENE FILM CAPACITOR
⊙	SEMICONDUCTIVE CERAMIC CAPACITOR
⊙	POLYPHENYLENE SULFIDE FILM CAPACITOR

NOTICE (model)

(J)..... JAPAN
 (U)..... U.S.A
 (C)..... CANADA
 (S)..... SWITZERLAND
 (T)..... CHINA
 (K)..... KOREA
 (A)..... AUSTRALIA
 (G)..... BRITISH
 (L)..... SINGAPORE
 (E)..... SOUTH
 (R)..... RUSSIA
 (F)..... RUSSIAN

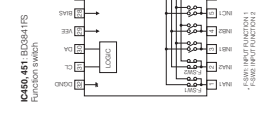
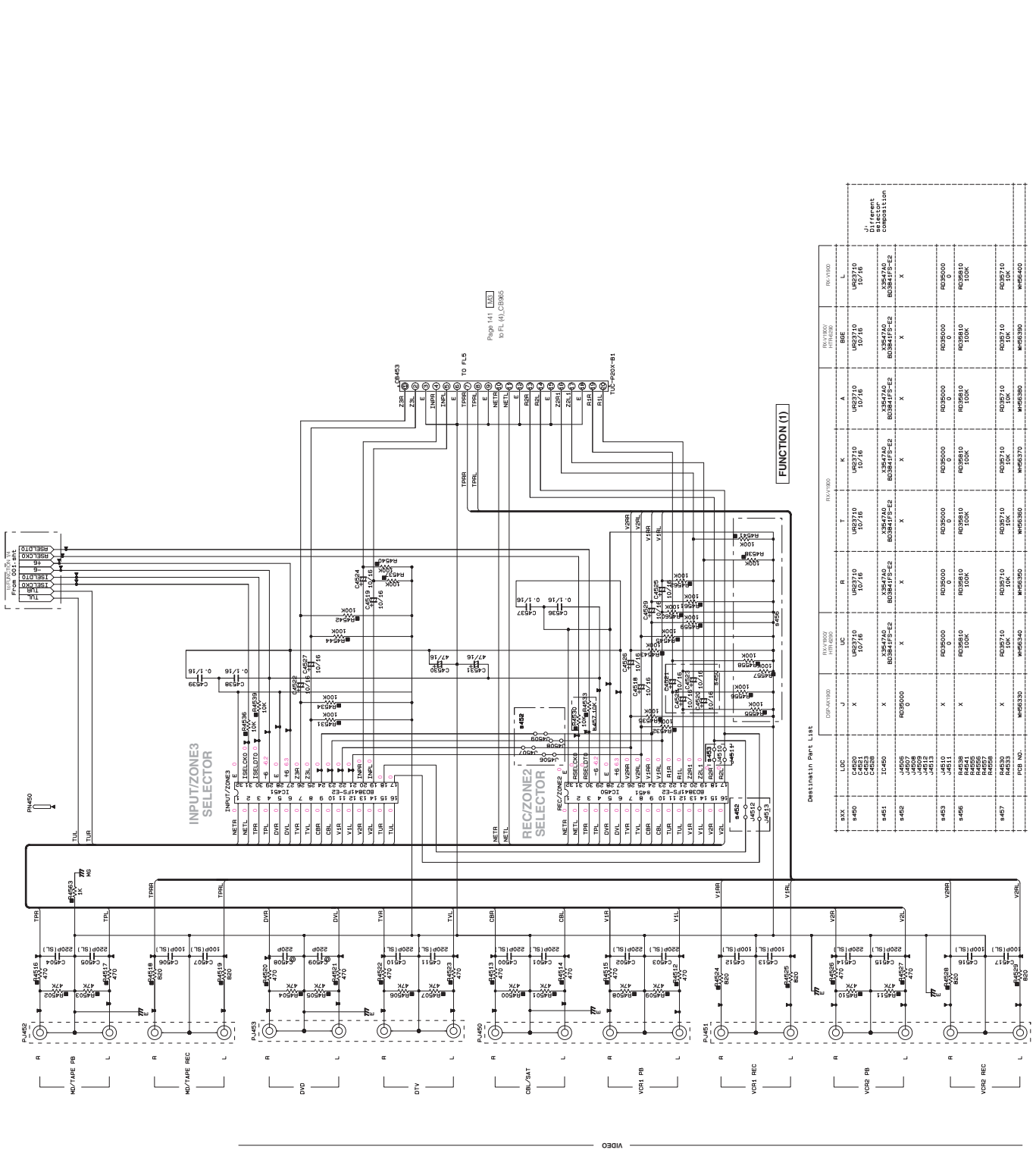

Delimiting Part List

PCB NO.	QTY	DESCRIPTION	PCB NO.	QTY	DESCRIPTION	PCB NO.	QTY	DESCRIPTION
AV	1	LDC	AV	1	AV	AV	1	AV
AV	1	C490	AV	1	AV	AV	1	AV
AV	1	C491	AV	1	AV	AV	1	AV
AV	1	C492	AV	1	AV	AV	1	AV
AV	1	C493	AV	1	AV	AV	1	AV
AV	1	C494	AV	1	AV	AV	1	AV
AV	1	C495	AV	1	AV	AV	1	AV
AV	1	C496	AV	1	AV	AV	1	AV
AV	1	C497	AV	1	AV	AV	1	AV
AV	1	C498	AV	1	AV	AV	1	AV
AV	1	C499	AV	1	AV	AV	1	AV
AV	1	C500	AV	1	AV	AV	1	AV
AV	1	C501	AV	1	AV	AV	1	AV
AV	1	C502	AV	1	AV	AV	1	AV
AV	1	C503	AV	1	AV	AV	1	AV
AV	1	C504	AV	1	AV	AV	1	AV
AV	1	C505	AV	1	AV	AV	1	AV
AV	1	C506	AV	1	AV	AV	1	AV
AV	1	C507	AV	1	AV	AV	1	AV
AV	1	C508	AV	1	AV	AV	1	AV
AV	1	C509	AV	1	AV	AV	1	AV
AV	1	C510	AV	1	AV	AV	1	AV
AV	1	C511	AV	1	AV	AV	1	AV
AV	1	C512	AV	1	AV	AV	1	AV
AV	1	C513	AV	1	AV	AV	1	AV
AV	1	C514	AV	1	AV	AV	1	AV
AV	1	C515	AV	1	AV	AV	1	AV
AV	1	C516	AV	1	AV	AV	1	AV
AV	1	C517	AV	1	AV	AV	1	AV
AV	1	C518	AV	1	AV	AV	1	AV
AV	1	C519	AV	1	AV	AV	1	AV
AV	1	C520	AV	1	AV	AV	1	AV
AV	1	C521	AV	1	AV	AV	1	AV
AV	1	C522	AV	1	AV	AV	1	AV
AV	1	C523	AV	1	AV	AV	1	AV
AV	1	C524	AV	1	AV	AV	1	AV
AV	1	C525	AV	1	AV	AV	1	AV
AV	1	C526	AV	1	AV	AV	1	AV
AV	1	C527	AV	1	AV	AV	1	AV
AV	1	C528	AV	1	AV	AV	1	AV
AV	1	C529	AV	1	AV	AV	1	AV
AV	1	C530	AV	1	AV	AV	1	AV
AV	1	C531	AV	1	AV	AV	1	AV
AV	1	C532	AV	1	AV	AV	1	AV
AV	1	C533	AV	1	AV	AV	1	AV
AV	1	C534	AV	1	AV	AV	1	AV
AV	1	C535	AV	1	AV	AV	1	AV
AV	1	C536	AV	1	AV	AV	1	AV
AV	1	C537	AV	1	AV	AV	1	AV
AV	1	C538	AV	1	AV	AV	1	AV
AV	1	C539	AV	1	AV	AV	1	AV
AV	1	C540	AV	1	AV	AV	1	AV
AV	1	C541	AV	1	AV	AV	1	AV
AV	1	C542	AV	1	AV	AV	1	AV
AV	1	C543	AV	1	AV	AV	1	AV
AV	1	C544	AV	1	AV	AV	1	AV
AV	1	C545	AV	1	AV	AV	1	AV
AV	1	C546	AV	1	AV	AV	1	AV
AV	1	C547	AV	1	AV	AV	1	AV
AV	1	C548	AV	1	AV	AV	1	AV
AV	1	C549	AV	1	AV	AV	1	AV
AV	1	C550	AV	1	AV	AV	1	AV
AV	1	C551	AV	1	AV	AV	1	AV
AV	1	C552	AV	1	AV	AV	1	AV
AV	1	C553	AV	1	AV	AV	1	AV
AV	1	C554	AV	1	AV	AV	1	AV
AV	1	C555	AV	1	AV	AV	1	AV
AV	1	C556	AV	1	AV	AV	1	AV
AV	1	C557	AV	1	AV	AV	1	AV
AV	1	C558	AV	1	AV	AV	1	AV
AV	1	C559	AV	1	AV	AV	1	AV
AV	1	C560	AV	1	AV	AV	1	AV
AV	1	C561	AV	1	AV	AV	1	AV
AV	1	C562	AV	1	AV	AV	1	AV
AV	1	C563	AV	1	AV	AV	1	AV
AV	1	C564	AV	1	AV	AV	1	AV
AV	1	C565	AV	1	AV	AV	1	AV
AV	1	C566	AV	1	AV	AV	1	AV
AV	1	C567	AV	1	AV	AV	1	AV
AV	1	C568	AV	1	AV	AV	1	AV
AV	1	C569	AV	1	AV	AV	1	AV
AV	1	C570	AV	1	AV	AV	1	AV
AV	1	C571	AV	1	AV	AV	1	AV
AV	1	C572	AV	1	AV	AV	1	AV
AV	1	C573	AV	1	AV	AV	1	AV
AV	1	C574	AV	1	AV	AV	1	AV
AV	1	C575	AV	1	AV	AV	1	AV
AV	1	C576	AV	1	AV	AV	1	AV
AV	1	C577	AV	1	AV	AV	1	AV
AV	1	C578	AV	1	AV	AV	1	AV
AV	1	C579	AV	1	AV	AV	1	AV
AV	1	C580	AV	1	AV	AV	1	AV
AV	1	C581	AV	1	AV	AV	1	AV
AV	1	C582	AV	1	AV	AV	1	AV
AV	1	C583	AV	1	AV	AV	1	AV
AV	1	C584	AV	1	AV	AV	1	AV
AV	1	C585	AV	1	AV	AV	1	AV
AV	1	C586	AV	1	AV	AV	1	AV
AV	1	C587	AV	1	AV	AV	1	AV
AV	1	C588	AV	1	AV	AV	1	AV
AV	1	C589	AV	1	AV	AV	1	AV
AV	1	C590	AV	1	AV	AV	1	AV
AV	1	C591	AV	1	AV	AV	1	AV
AV	1	C592	AV	1	AV	AV	1	AV
AV	1	C593	AV	1	AV	AV	1	AV
AV	1	C594	AV	1	AV	AV	1	AV
AV	1	C595	AV	1	AV	AV	1	AV
AV	1	C596	AV	1	AV	AV	1	AV
AV	1	C597	AV	1	AV	AV	1	AV
AV	1	C598	AV	1	AV	AV	1	AV
AV	1	C599	AV	1	AV	AV	1	AV
AV	1	C600	AV	1	AV	AV	1	AV
AV	1	C601	AV	1	AV	AV	1	AV
AV	1	C602	AV	1	AV	AV	1	AV
AV	1	C603	AV	1	AV	AV	1	AV
AV	1	C604	AV	1	AV	AV	1	AV
AV	1	C605	AV	1	AV	AV	1	AV
AV	1	C606	AV	1	AV	AV	1	AV
AV	1	C607	AV	1	AV	AV	1	AV
AV	1	C608	AV	1	AV	AV	1	AV
AV	1	C609	AV	1	AV	AV	1	AV
AV	1	C610	AV	1	AV	AV	1	AV
AV	1	C611	AV	1	AV	AV	1	AV
AV	1	C612	AV	1	AV	AV	1	AV
AV	1	C613	AV	1	AV	AV	1	AV
AV	1	C614	AV	1	AV	AV	1	AV
AV	1	C615	AV	1	AV	AV	1	AV
AV	1	C616	AV	1	AV	AV	1	AV
AV	1	C617	AV	1	AV	AV	1	AV
AV	1	C618	AV	1	AV	AV	1	AV
AV	1	C619	AV	1	AV	AV	1	AV
AV	1	C620	AV	1	AV	AV	1	AV
AV	1	C621	AV	1	AV	AV	1	AV
AV	1	C622	AV	1	AV	AV	1	AV
AV	1	C623	AV	1	AV	AV	1	AV
AV	1	C624	AV	1	AV	AV	1	AV
AV	1	C625	AV	1	AV	AV	1	AV
AV	1	C626	AV	1	AV	AV	1	AV
AV	1	C627	AV	1	AV	AV	1	AV
AV	1	C628	AV	1	AV	AV	1	AV
AV	1	C629	AV	1	AV	AV	1	AV
AV	1	C630	AV	1	AV	AV	1	AV
AV	1	C631	AV	1	AV	AV	1	AV
AV	1	C632	AV	1	AV	AV	1	AV
AV	1	C633	AV	1	AV	AV	1	AV
AV	1	C634	AV	1	AV	AV	1	AV
AV	1	C635	AV	1	AV	AV	1	AV
AV	1	C636	AV	1	AV	AV	1	AV
AV	1	C637	AV	1	AV	AV	1	AV
AV	1	C638	AV	1	AV	AV	1	AV
AV	1	C639	AV	1	AV	AV	1	AV
AV	1	C640	AV	1	AV	AV	1	AV
AV	1	C641	AV	1	AV	AV	1	AV
AV	1	C642	AV	1	AV	AV	1	AV
AV								

FUNCTION 3/4

Page 132
TO POWER (3), C850

Page 130
TO OPERATION (3), C856

Page 131
TO MAIN (1), W273

Page 141
TO FL (3), C857

Page 141
TO FL (3), C856

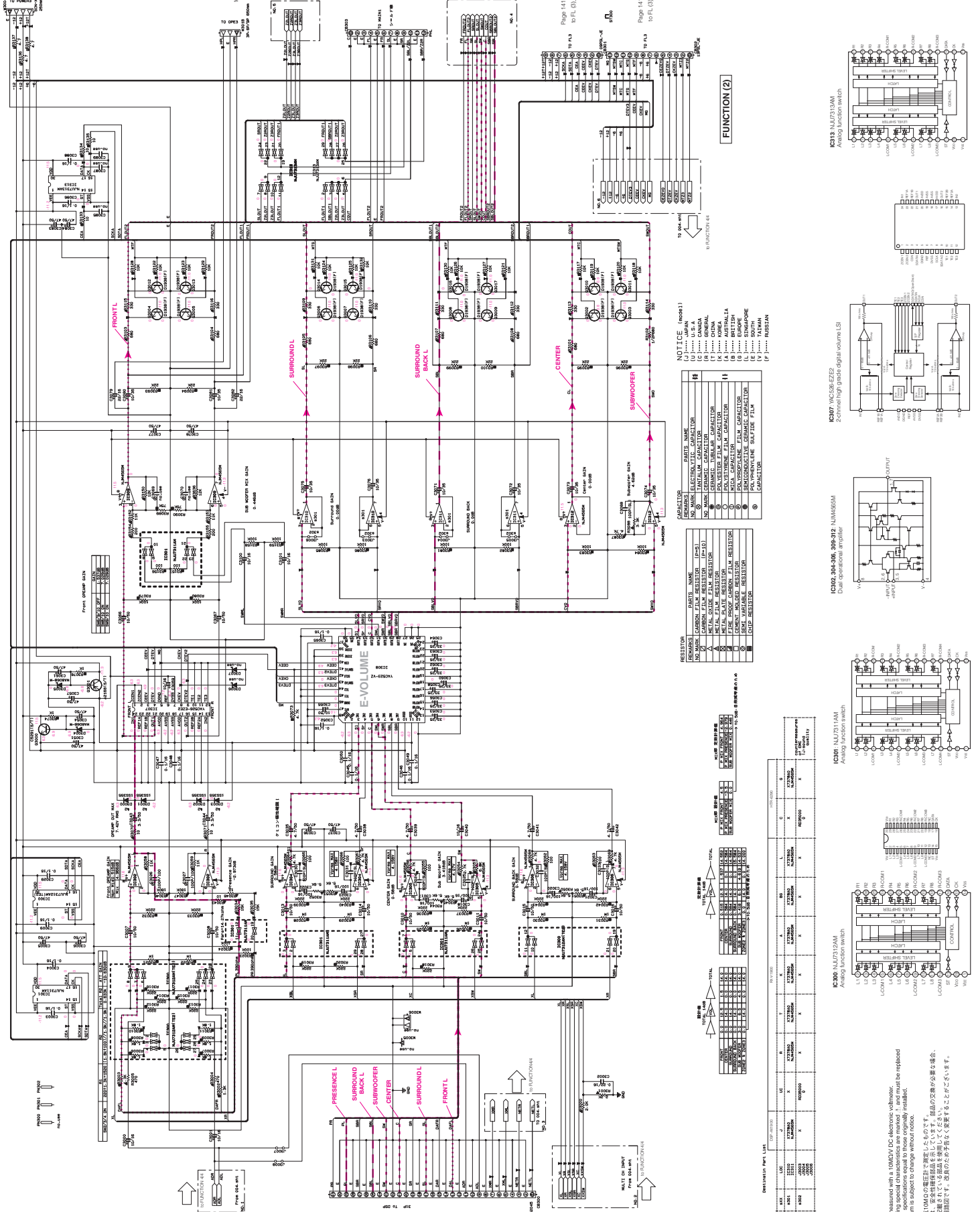

NOTICE (codes)

RESISTOR	RESISTOR NAME	RESISTOR VALUE
(1)	CARBON FILM RESISTOR (F=3)	10kΩ
(2)	METAL FILM RESISTOR	10kΩ
(3)	METAL FILM RESISTOR	10kΩ
(4)	FILM RESISTOR	10kΩ
(5)	FILM RESISTOR	10kΩ
(6)	FILM RESISTOR	10kΩ
(7)	FILM RESISTOR	10kΩ
(8)	FILM RESISTOR	10kΩ
(9)	FILM RESISTOR	10kΩ
(10)	FILM RESISTOR	10kΩ

CAPACITOR	CAPACITOR NAME	CAPACITOR VALUE
(1)	NON POLAR CAPACITOR	100nF
(2)	NON POLAR CAPACITOR	100nF
(3)	NON POLAR CAPACITOR	100nF
(4)	NON POLAR CAPACITOR	100nF
(5)	NON POLAR CAPACITOR	100nF
(6)	NON POLAR CAPACITOR	100nF
(7)	NON POLAR CAPACITOR	100nF
(8)	NON POLAR CAPACITOR	100nF
(9)	NON POLAR CAPACITOR	100nF
(10)	NON POLAR CAPACITOR	100nF

* All voltages are measured with a 10MΩ DC electronic voltmeter.
 * Components having special characteristics are marked (1) and must be replaced with the same type.
 * Schematic diagram is subject to change without notice.

● 電圧は、10MΩの電圧計で測定したものです。
 ● 1印のある部品は、特別な特性を示しています。部品の交換が必要の場合は、同じタイプの部品で置き換えてください。
 ● 回路図は予告なく変更されることがあります。

FUNCTION (2)

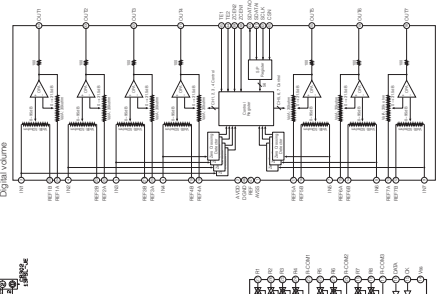

FUNCTION (2)

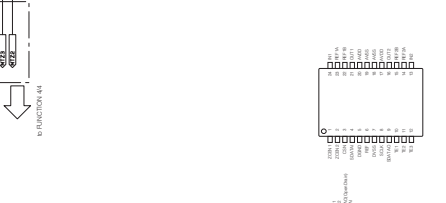

FUNCTION (2)

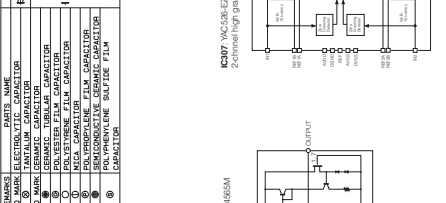

FUNCTION (2)

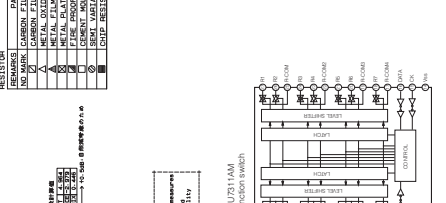

FUNCTION (2)

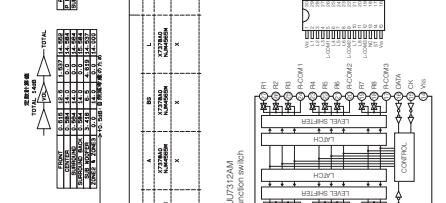

FUNCTION (2)

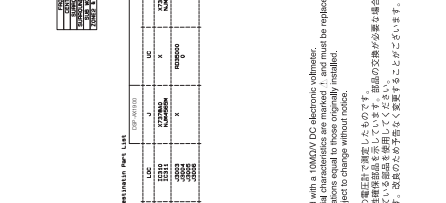

FUNCTION (2)



IC360 NM4094MD-EZ Dual operational amplifier

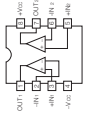

IC381 NM4094M Dual operational amplifier

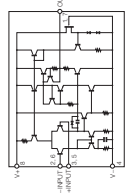

IC385 385 RS3851FS 8-channel audio processor

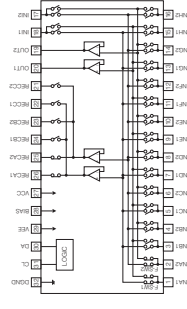

IC387 388 WC636-EZ2 2-channel video signal source LSI

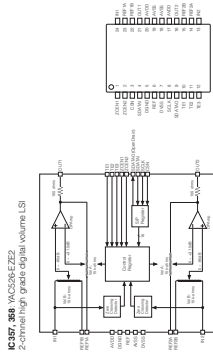

IC389 389 MUM115AV 3-band tone control IC

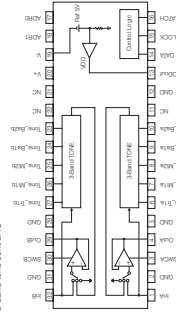

IC No.	FUNCTION		VOLTAGE		TEMPERATURE		REMARKS
	LOC	REF	V	W	T	R	
IC01	2081	X	5	5	5	5	5
IC02	2082	X	5	5	5	5	5
IC03	2083	X	5	5	5	5	5
IC04	2084	X	5	5	5	5	5
IC05	2085	X	5	5	5	5	5
IC06	2086	X	5	5	5	5	5
IC07	2087	X	5	5	5	5	5
IC08	2088	X	5	5	5	5	5
IC09	2089	X	5	5	5	5	5
IC10	2090	X	5	5	5	5	5
IC11	2091	X	5	5	5	5	5
IC12	2092	X	5	5	5	5	5
IC13	2093	X	5	5	5	5	5
IC14	2094	X	5	5	5	5	5
IC15	2095	X	5	5	5	5	5
IC16	2096	X	5	5	5	5	5
IC17	2097	X	5	5	5	5	5
IC18	2098	X	5	5	5	5	5
IC19	2099	X	5	5	5	5	5
IC20	2100	X	5	5	5	5	5
IC21	2101	X	5	5	5	5	5
IC22	2102	X	5	5	5	5	5
IC23	2103	X	5	5	5	5	5
IC24	2104	X	5	5	5	5	5
IC25	2105	X	5	5	5	5	5
IC26	2106	X	5	5	5	5	5
IC27	2107	X	5	5	5	5	5
IC28	2108	X	5	5	5	5	5
IC29	2109	X	5	5	5	5	5
IC30	2110	X	5	5	5	5	5
IC31	2111	X	5	5	5	5	5
IC32	2112	X	5	5	5	5	5
IC33	2113	X	5	5	5	5	5
IC34	2114	X	5	5	5	5	5
IC35	2115	X	5	5	5	5	5
IC36	2116	X	5	5	5	5	5
IC37	2117	X	5	5	5	5	5
IC38	2118	X	5	5	5	5	5
IC39	2119	X	5	5	5	5	5
IC40	2120	X	5	5	5	5	5
IC41	2121	X	5	5	5	5	5
IC42	2122	X	5	5	5	5	5
IC43	2123	X	5	5	5	5	5
IC44	2124	X	5	5	5	5	5
IC45	2125	X	5	5	5	5	5
IC46	2126	X	5	5	5	5	5
IC47	2127	X	5	5	5	5	5
IC48	2128	X	5	5	5	5	5
IC49	2129	X	5	5	5	5	5
IC50	2130	X	5	5	5	5	5
IC51	2131	X	5	5	5	5	5
IC52	2132	X	5	5	5	5	5
IC53	2133	X	5	5	5	5	5
IC54	2134	X	5	5	5	5	5
IC55	2135	X	5	5	5	5	5
IC56	2136	X	5	5	5	5	5
IC57	2137	X	5	5	5	5	5
IC58	2138	X	5	5	5	5	5
IC59	2139	X	5	5	5	5	5
IC60	2140	X	5	5	5	5	5
IC61	2141	X	5	5	5	5	5
IC62	2142	X	5	5	5	5	5
IC63	2143	X	5	5	5	5	5
IC64	2144	X	5	5	5	5	5
IC65	2145	X	5	5	5	5	5
IC66	2146	X	5	5	5	5	5
IC67	2147	X	5	5	5	5	5
IC68	2148	X	5	5	5	5	5
IC69	2149	X	5	5	5	5	5
IC70	2150	X	5	5	5	5	5
IC71	2151	X	5	5	5	5	5
IC72	2152	X	5	5	5	5	5
IC73	2153	X	5	5	5	5	5
IC74	2154	X	5	5	5	5	5
IC75	2155	X	5	5	5	5	5
IC76	2156	X	5	5	5	5	5
IC77	2157	X	5	5	5	5	5
IC78	2158	X	5	5	5	5	5
IC79	2159	X	5	5	5	5	5
IC80	2160	X	5	5	5	5	5
IC81	2161	X	5	5	5	5	5
IC82	2162	X	5	5	5	5	5
IC83	2163	X	5	5	5	5	5
IC84	2164	X	5	5	5	5	5
IC85	2165	X	5	5	5	5	5
IC86	2166	X	5	5	5	5	5
IC87	2167	X	5	5	5	5	5
IC88	2168	X	5	5	5	5	5
IC89	2169	X	5	5	5	5	5
IC90	2170	X	5	5	5	5	5
IC91	2171	X	5	5	5	5	5
IC92	2172	X	5	5	5	5	5
IC93	2173	X	5	5	5	5	5
IC94	2174	X	5	5	5	5	5
IC95	2175	X	5	5	5	5	5
IC96	2176	X	5	5	5	5	5
IC97	2177	X	5	5	5	5	5
IC98	2178	X	5	5	5	5	5
IC99	2179	X	5	5	5	5	5
IC100	2180	X	5	5	5	5	5

NOTICE (note 1)
 (1) JAPAN U.S.A.
 (2) JAPAN U.S.A.
 (3) JAPAN U.S.A.
 (4) JAPAN U.S.A.
 (5) JAPAN U.S.A.
 (6) JAPAN U.S.A.
 (7) JAPAN U.S.A.
 (8) JAPAN U.S.A.
 (9) JAPAN U.S.A.
 (10) JAPAN U.S.A.

- RESISTOR
- ① JAPAN U.S.A.
 - ② JAPAN U.S.A.
 - ③ JAPAN U.S.A.
 - ④ JAPAN U.S.A.
 - ⑤ JAPAN U.S.A.
 - ⑥ JAPAN U.S.A.
 - ⑦ JAPAN U.S.A.
 - ⑧ JAPAN U.S.A.
 - ⑨ JAPAN U.S.A.
 - ⑩ JAPAN U.S.A.
- CAPACITOR
- ① JAPAN U.S.A.
 - ② JAPAN U.S.A.
 - ③ JAPAN U.S.A.
 - ④ JAPAN U.S.A.
 - ⑤ JAPAN U.S.A.
 - ⑥ JAPAN U.S.A.
 - ⑦ JAPAN U.S.A.
 - ⑧ JAPAN U.S.A.
 - ⑨ JAPAN U.S.A.
 - ⑩ JAPAN U.S.A.

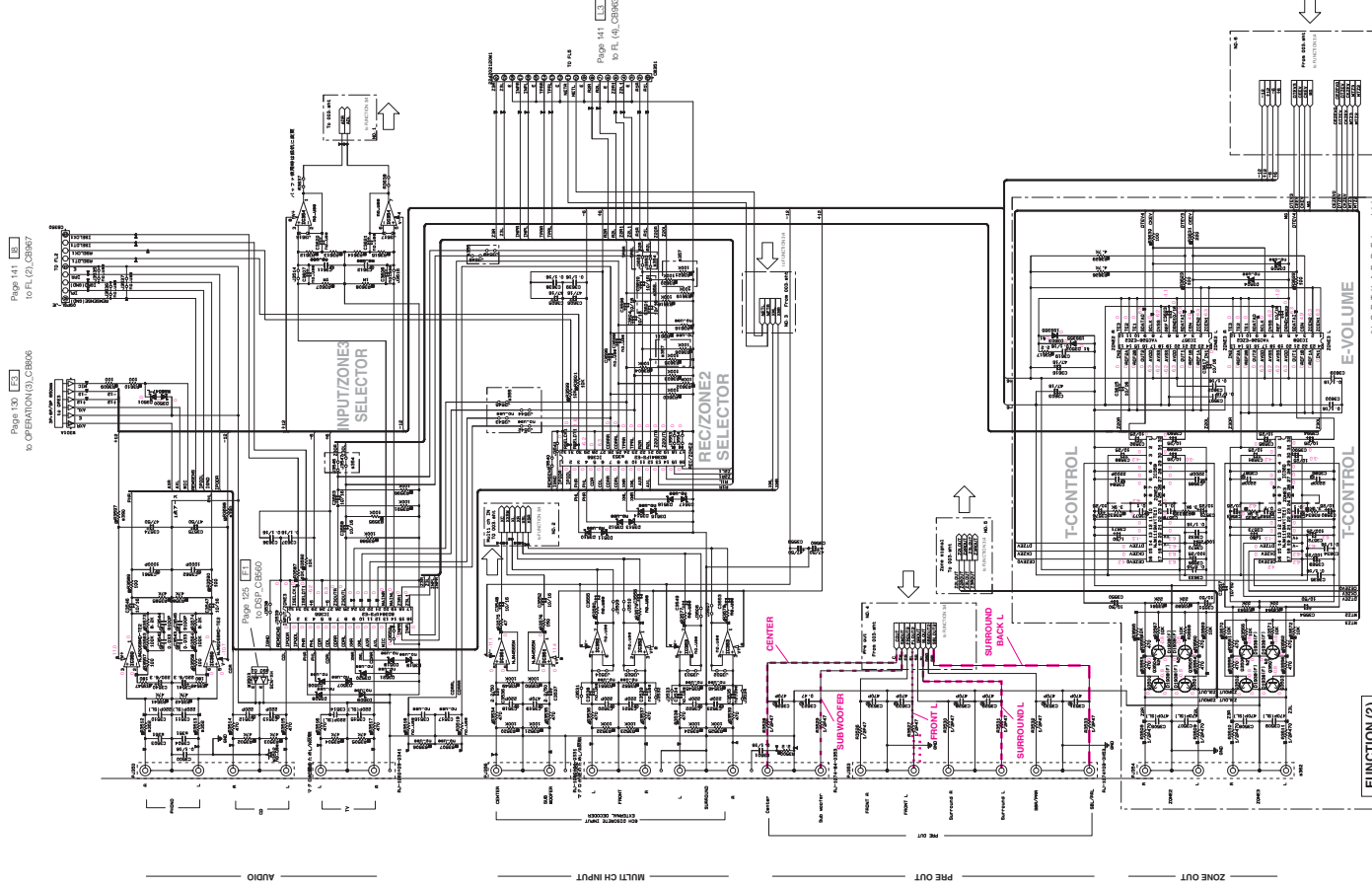

* All voltages are measured with a 10MΩ VDC electronic voltmeter.
 * Components having special characteristics are marked - and must be replaced accordingly.
 * Schematic diagram is subject to change without notice.

OPERATION

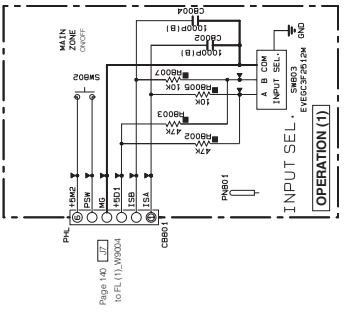

OPERATION (1)
INPUT SEL.

Page 140 [L1]
to FL (1), W0004

Page 129 [L2]
to DSP, W0001

Page 129 [L3]
to FUNCTION, W001A

Page 128 [L4]
to FUNCTION, W001B

Page 134 [L2]
to A/VIDEO, W002

Page 141 [L3]
to FL (2), C037

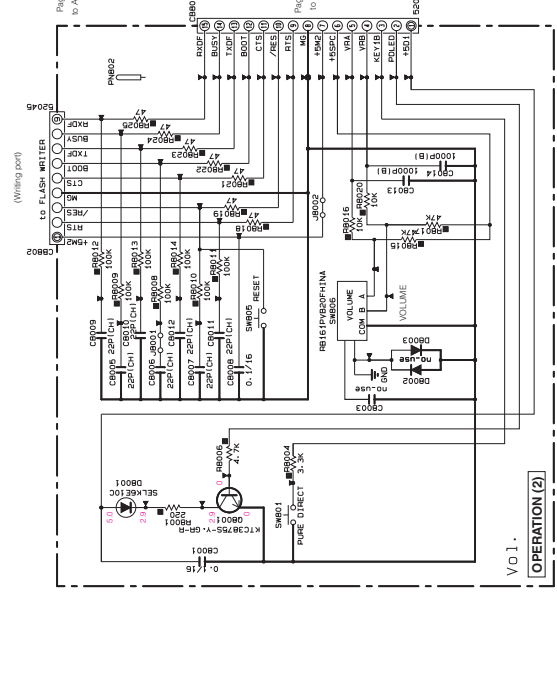

OPERATION (2)
VOL.

Page 134 [L2]
to A/VIDEO, W002

Page 141 [L3]
to FL (2), C037

Page 142 [L3]
to NET, W003

Page 142 [L3]
to NET, W003

Page 142 [L3]
to NET, W003

Page 142 [L3]
to NET, W003

Page 142 [L3]
to NET, W003

Page 142 [L3]
to NET, W003

Page 142 [L3]
to NET, W003

Page 142 [L3]
to NET, W003

Page 142 [L3]
to NET, W003

Page 142 [L3]
to NET, W003

Page 142 [L3]
to NET, W003

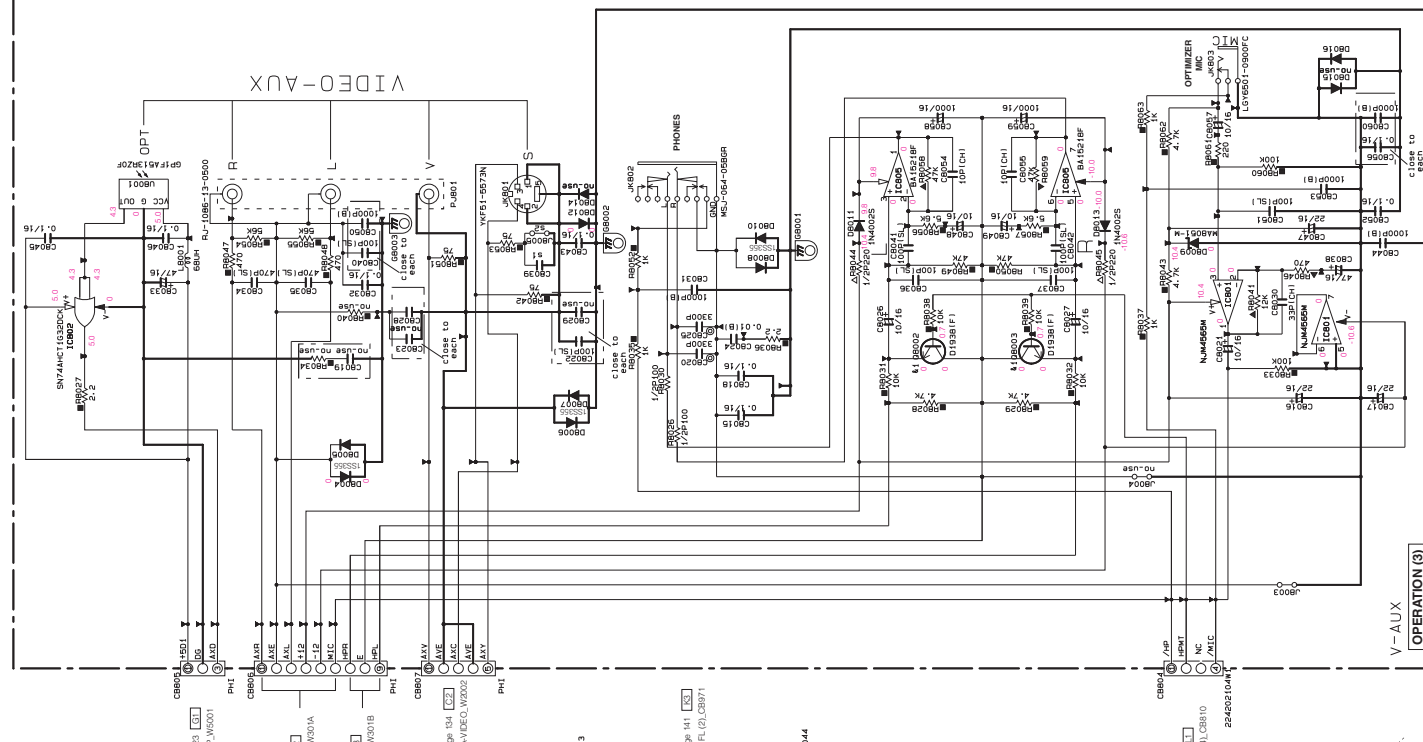

OPERATION (3)
V-AUX

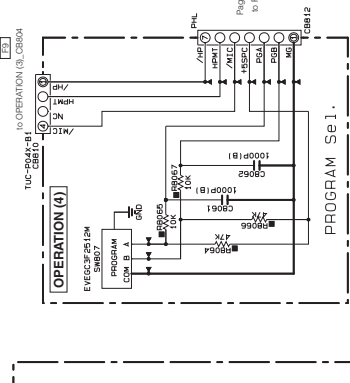

OPERATION (4)
PROGRAM SEL.

Page 140 [L2]
to FL (1), W0003

Page 140 [L3]
to FL (1), W0002

Page 142 [L3]
to NET, W003

Page 142 [L3]
to NET, W003

Page 142 [L3]
to NET, W003

Page 142 [L3]
to NET, W003

Page 142 [L3]
to NET, W003

Page 142 [L3]
to NET, W003

Page 142 [L3]
to NET, W003

Page 142 [L3]
to NET, W003

Page 142 [L3]
to NET, W003

Page 142 [L3]
to NET, W003

Page 142 [L3]
to NET, W003

Page 142 [L3]
to NET, W003

Page 142 [L3]
to NET, W003

Page 142 [L3]
to NET, W003

Page 142 [L3]
to NET, W003

Page 142 [L3]
to NET, W003

Page 142 [L3]
to NET, W003

Page 142 [L3]
to NET, W003

Page 142 [L3]
to NET, W003

Page 142 [L3]
to NET, W003

Page 142 [L3]
to NET, W003

Page 142 [L3]
to NET, W003

Page 142 [L3]
to NET, W003

Page 142 [L3]
to NET, W003

Page 142 [L3]
to NET, W003

Page 142 [L3]
to NET, W003

Page 142 [L3]
to NET, W003

NOTICE (pages 1)
(J)..... JAPAN
(U)..... U.S.A.
(C)..... CANADA
(R)..... GENERAL
(K)..... CHINA
(A)..... AUSTRALIA
(B)..... BRITISH
(G)..... SINGAPORE
(E)..... SOUTH EUROPE
(F)..... RUSSIAN

Mark.	Reference Parts Number	Parts Name
41	08006-0003	25019981F1
		25019981F1
		25019981A1
		25019981B1
		25019981C1
		25019981D1
		25019981E1
		25019981F1
		25019981G1
		25019981H1
		25019981I1
		25019981J1
		25019981K1
		25019981L1
		25019981M1
		25019981N1
		25019981O1
		25019981P1
		25019981Q1
		25019981R1
		25019981S1
		25019981T1
		25019981U1
		25019981V1
		25019981W1
		25019981X1
		25019981Y1
		25019981Z1

Restriction Part List	JUC	RT-LABEL
8X	LOC	X
51	CB039	U513910
82	89006	RD30010
		0

● 正圧は、各回路に100Vの電圧が印加された状態で測定したものです。
● 正圧のある部品は、安全情報欄に表示していません。回路の交換が必要の場合、
Aマークが示した部品に同等以上の部品を挿入してください。
● 部品間の接続は、必ずしも図面に示した通りで行ってください。

REMARKS	PARTS NAME
✓	CARBON FILM RESISTOR (P=5)
✓	CARBON FILM RESISTOR (P=10)
✓	METAL FILM RESISTOR
✓	METAL PLATE RESISTOR
✓	FIRE PROOF CARBON FILM RESISTOR
✓	CEMENT MOLDED RESISTOR
✓	CHIP RESISTOR
CAPACITOR	
REMARKS	PARTS NAME
⊗	ELECTROLYTIC CAPACITOR
⊙	TANTALUM CAPACITOR
⊙	CERAMIC CAPACITOR
⊙	CERAMIC TUBULAR CAPACITOR
⊙	POLYESTER FILM CAPACITOR
⊙	POLYSTYRENE FILM CAPACITOR
⊙	MICA CAPACITOR
⊙	POLYPROPYLENE FILM CAPACITOR
⊙	SEMICONDUCTIVE CERAMIC CAPACITOR

IMPLEMENTATION:
INPUT SELECTOR
VOLUME
HEAD PHONES AMP
MIC AMP
SELECTOR
MASTER SWITCH

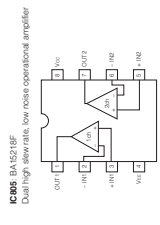

IC005 BA1218F
Dual high slew rate, low noise operational amplifier

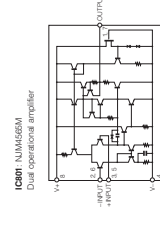

IC001 UM1065M
Dual operational amplifier

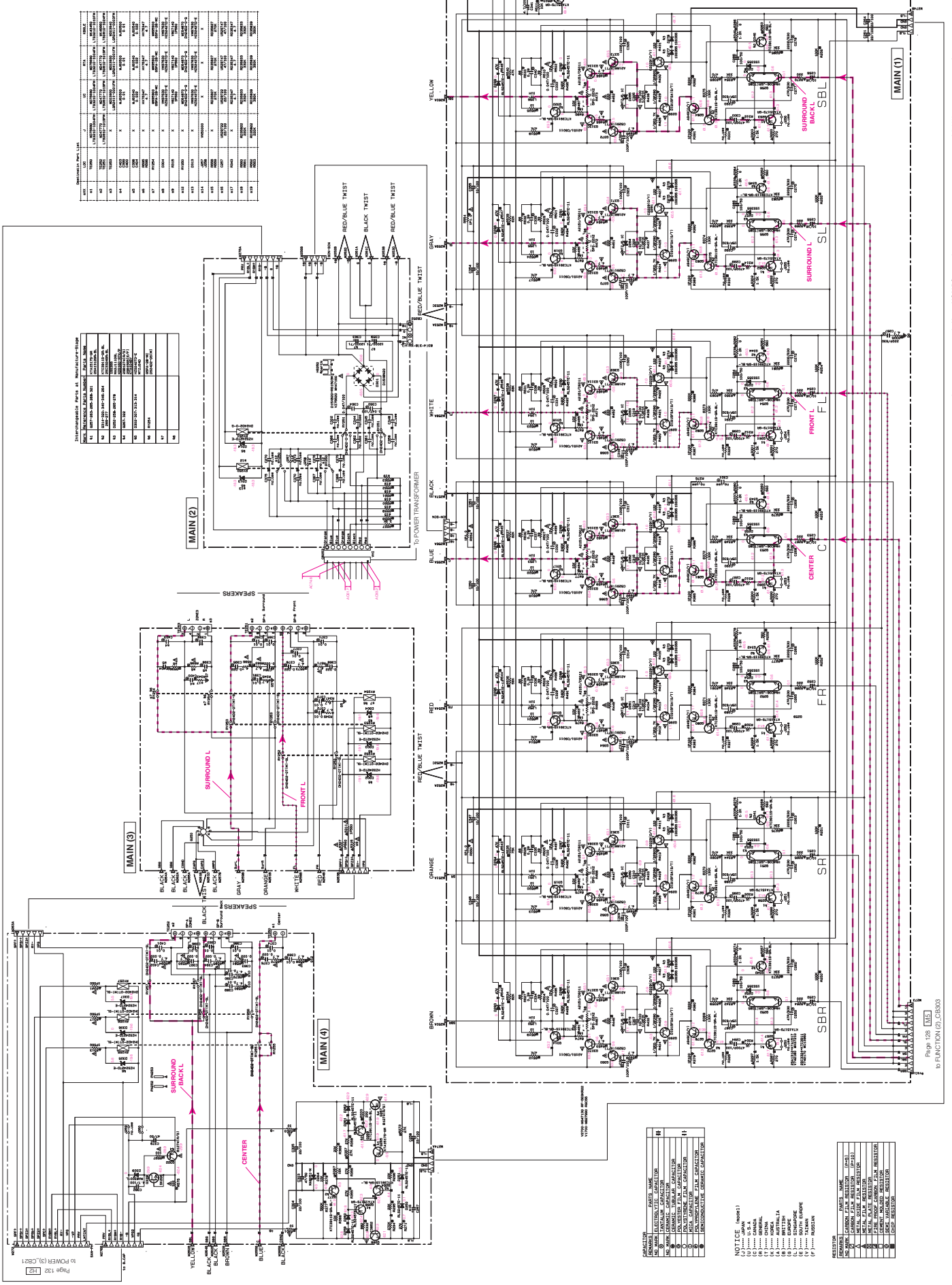

COMPONENTS LIST

NO.	QTY	REF. DESIG.	MARKING	UNIT	REMARKS
1	1	IC1	74VHC00	IC	CMOS INVERTER
2	1	IC2	74VHC04	IC	CMOS INVERTER
3	1	IC3	74VHC00	IC	CMOS INVERTER
4	1	IC4	74VHC04	IC	CMOS INVERTER
5	1	IC5	74VHC00	IC	CMOS INVERTER
6	1	IC6	74VHC04	IC	CMOS INVERTER
7	1	IC7	74VHC00	IC	CMOS INVERTER
8	1	IC8	74VHC04	IC	CMOS INVERTER
9	1	IC9	74VHC00	IC	CMOS INVERTER
10	1	IC10	74VHC04	IC	CMOS INVERTER
11	1	IC11	74VHC00	IC	CMOS INVERTER
12	1	IC12	74VHC04	IC	CMOS INVERTER
13	1	IC13	74VHC00	IC	CMOS INVERTER
14	1	IC14	74VHC04	IC	CMOS INVERTER
15	1	IC15	74VHC00	IC	CMOS INVERTER
16	1	IC16	74VHC04	IC	CMOS INVERTER
17	1	IC17	74VHC00	IC	CMOS INVERTER
18	1	IC18	74VHC04	IC	CMOS INVERTER
19	1	IC19	74VHC00	IC	CMOS INVERTER
20	1	IC20	74VHC04	IC	CMOS INVERTER
21	1	IC21	74VHC00	IC	CMOS INVERTER
22	1	IC22	74VHC04	IC	CMOS INVERTER
23	1	IC23	74VHC00	IC	CMOS INVERTER
24	1	IC24	74VHC04	IC	CMOS INVERTER
25	1	IC25	74VHC00	IC	CMOS INVERTER
26	1	IC26	74VHC04	IC	CMOS INVERTER
27	1	IC27	74VHC00	IC	CMOS INVERTER
28	1	IC28	74VHC04	IC	CMOS INVERTER
29	1	IC29	74VHC00	IC	CMOS INVERTER
30	1	IC30	74VHC04	IC	CMOS INVERTER
31	1	IC31	74VHC00	IC	CMOS INVERTER
32	1	IC32	74VHC04	IC	CMOS INVERTER
33	1	IC33	74VHC00	IC	CMOS INVERTER
34	1	IC34	74VHC04	IC	CMOS INVERTER
35	1	IC35	74VHC00	IC	CMOS INVERTER
36	1	IC36	74VHC04	IC	CMOS INVERTER
37	1	IC37	74VHC00	IC	CMOS INVERTER
38	1	IC38	74VHC04	IC	CMOS INVERTER
39	1	IC39	74VHC00	IC	CMOS INVERTER
40	1	IC40	74VHC04	IC	CMOS INVERTER
41	1	IC41	74VHC00	IC	CMOS INVERTER
42	1	IC42	74VHC04	IC	CMOS INVERTER
43	1	IC43	74VHC00	IC	CMOS INVERTER
44	1	IC44	74VHC04	IC	CMOS INVERTER
45	1	IC45	74VHC00	IC	CMOS INVERTER
46	1	IC46	74VHC04	IC	CMOS INVERTER
47	1	IC47	74VHC00	IC	CMOS INVERTER
48	1	IC48	74VHC04	IC	CMOS INVERTER
49	1	IC49	74VHC00	IC	CMOS INVERTER
50	1	IC50	74VHC04	IC	CMOS INVERTER

FUNCTIONS LIST

NO.	FUNCTION	MARKING	REMARKS
1	POWER SUPPLY	PS	
2	AMPLIFIER	AMP	
3	OSCILLATOR	OSC	
4	DEMODULATOR	DEM	
5	VIDEO PROCESSOR	VID	
6	AUDIO PROCESSOR	AUD	
7	VIDEO SYNCHRONIZER	VIDS	
8	VIDEO FILTER	VIDF	
9	VIDEO ENHANCER	VIDE	
10	VIDEO GATING	VIDG	
11	VIDEO DETECTION	VIDD	
12	VIDEO EQUALIZER	VIDE	
13	VIDEO COMPRESSION	VIDC	
14	VIDEO EXPANSION	VIDX	
15	VIDEO STRETCHING	VIDS	
16	VIDEO SQUEEZING	VIDZ	
17	VIDEO SCANNING	VIDS	
18	VIDEO DEINTERLACING	VIDDI	
19	VIDEO DEBLOCKING	VIDDB	
20	VIDEO DECRYPTION	VIDDC	
21	VIDEO ENCRYPTION	VIDEC	
22	VIDEO DEINTERLACING	VIDDI	
23	VIDEO DEBLOCKING	VIDDB	
24	VIDEO DECRYPTION	VIDDC	
25	VIDEO ENCRYPTION	VIDEC	

NOTICE

MARKING	DESCRIPTION
1	RESISTOR
2	CAPACITOR
3	DIODE
4	TRIPPLE CAPACITOR
5	INDUCTOR
6	TRANSISTOR
7	IC
8	RELAY
9	CONNECTOR
10	SWITCH
11	OTHER

RESISTOR

MARKING	RESISTANCE
0	0 OHMS
1	10 OHMS
2	20 OHMS
3	30 OHMS
4	40 OHMS
5	50 OHMS
6	60 OHMS
7	70 OHMS
8	80 OHMS
9	90 OHMS
10	1.0 K OHMS
11	1.1 K OHMS
12	1.2 K OHMS
13	1.3 K OHMS
14	1.4 K OHMS
15	1.5 K OHMS
16	1.6 K OHMS
17	1.7 K OHMS
18	1.8 K OHMS
19	1.9 K OHMS
20	2.0 K OHMS
21	2.2 K OHMS
22	2.4 K OHMS
23	2.7 K OHMS
24	3.0 K OHMS
25	3.3 K OHMS
26	3.6 K OHMS
27	3.9 K OHMS
28	4.3 K OHMS
29	4.7 K OHMS
30	5.1 K OHMS
31	5.6 K OHMS
32	6.2 K OHMS
33	6.8 K OHMS
34	7.5 K OHMS
35	8.2 K OHMS
36	9.1 K OHMS
37	10.0 K OHMS
38	11.0 K OHMS
39	12.0 K OHMS
40	13.0 K OHMS
41	15.0 K OHMS
42	16.0 K OHMS
43	18.0 K OHMS
44	20.0 K OHMS
45	22.0 K OHMS
46	24.0 K OHMS
47	27.0 K OHMS
48	30.0 K OHMS
49	33.0 K OHMS
50	36.0 K OHMS
51	39.0 K OHMS
52	43.0 K OHMS
53	47.0 K OHMS
54	51.0 K OHMS
55	56.0 K OHMS
56	62.0 K OHMS
57	68.0 K OHMS
58	75.0 K OHMS
59	82.0 K OHMS
60	91.0 K OHMS
61	100 K OHMS
62	110 K OHMS
63	120 K OHMS
64	130 K OHMS
65	150 K OHMS
66	160 K OHMS
67	180 K OHMS
68	200 K OHMS
69	220 K OHMS
70	240 K OHMS
71	270 K OHMS
72	300 K OHMS
73	330 K OHMS
74	360 K OHMS
75	390 K OHMS
76	430 K OHMS
77	470 K OHMS
78	510 K OHMS
79	560 K OHMS
80	620 K OHMS
81	680 K OHMS
82	750 K OHMS
83	820 K OHMS
84	910 K OHMS
85	1.0 M OHMS
86	1.1 M OHMS
87	1.2 M OHMS
88	1.3 M OHMS
89	1.5 M OHMS
90	1.6 M OHMS
91	1.8 M OHMS
92	2.0 M OHMS
93	2.2 M OHMS
94	2.4 M OHMS
95	2.7 M OHMS
96	3.0 M OHMS
97	3.3 M OHMS
98	3.6 M OHMS
99	3.9 M OHMS
100	4.3 M OHMS
101	4.7 M OHMS
102	5.1 M OHMS
103	5.6 M OHMS
104	6.2 M OHMS
105	6.8 M OHMS
106	7.5 M OHMS
107	8.2 M OHMS
108	9.1 M OHMS
109	10.0 M OHMS
110	11.0 M OHMS
111	12.0 M OHMS
112	13.0 M OHMS
113	15.0 M OHMS
114	16.0 M OHMS
115	18.0 M OHMS
116	20.0 M OHMS
117	22.0 M OHMS
118	24.0 M OHMS
119	27.0 M OHMS
120	30.0 M OHMS
121	33.0 M OHMS
122	36.0 M OHMS
123	39.0 M OHMS
124	43.0 M OHMS
125	47.0 M OHMS
126	51.0 M OHMS
127	56.0 M OHMS
128	62.0 M OHMS
129	68.0 M OHMS
130	75.0 M OHMS
131	82.0 M OHMS
132	91.0 M OHMS
133	100 M OHMS

POWER

NOTICE (cont.)

- 1) All components are measured with a 100MΩ DC electronic voltmeter.
- 2) Components having special characteristics are marked * and must be replaced with parts having specifications equal to those originally installed.
- 3) Schematic diagrams are subject to change without notice.

REVISION

NO.	DATE	DESCRIPTION
1	2008.08.20	INITIAL RELEASE
2	2009.03.10	REVISION OF POWER SUPPLY CIRCUIT
3	2009.03.10	REVISION OF POWER SUPPLY CIRCUIT
4	2009.03.10	REVISION OF POWER SUPPLY CIRCUIT
5	2009.03.10	REVISION OF POWER SUPPLY CIRCUIT
6	2009.03.10	REVISION OF POWER SUPPLY CIRCUIT
7	2009.03.10	REVISION OF POWER SUPPLY CIRCUIT
8	2009.03.10	REVISION OF POWER SUPPLY CIRCUIT
9	2009.03.10	REVISION OF POWER SUPPLY CIRCUIT
10	2009.03.10	REVISION OF POWER SUPPLY CIRCUIT

REVISION

NO.	DATE	DESCRIPTION
1	2008.08.20	INITIAL RELEASE
2	2009.03.10	REVISION OF POWER SUPPLY CIRCUIT
3	2009.03.10	REVISION OF POWER SUPPLY CIRCUIT
4	2009.03.10	REVISION OF POWER SUPPLY CIRCUIT
5	2009.03.10	REVISION OF POWER SUPPLY CIRCUIT
6	2009.03.10	REVISION OF POWER SUPPLY CIRCUIT
7	2009.03.10	REVISION OF POWER SUPPLY CIRCUIT
8	2009.03.10	REVISION OF POWER SUPPLY CIRCUIT
9	2009.03.10	REVISION OF POWER SUPPLY CIRCUIT
10	2009.03.10	REVISION OF POWER SUPPLY CIRCUIT

Page 140 [52]
 to FL (1), W901
 To PCB-FL
 (Front Panel)

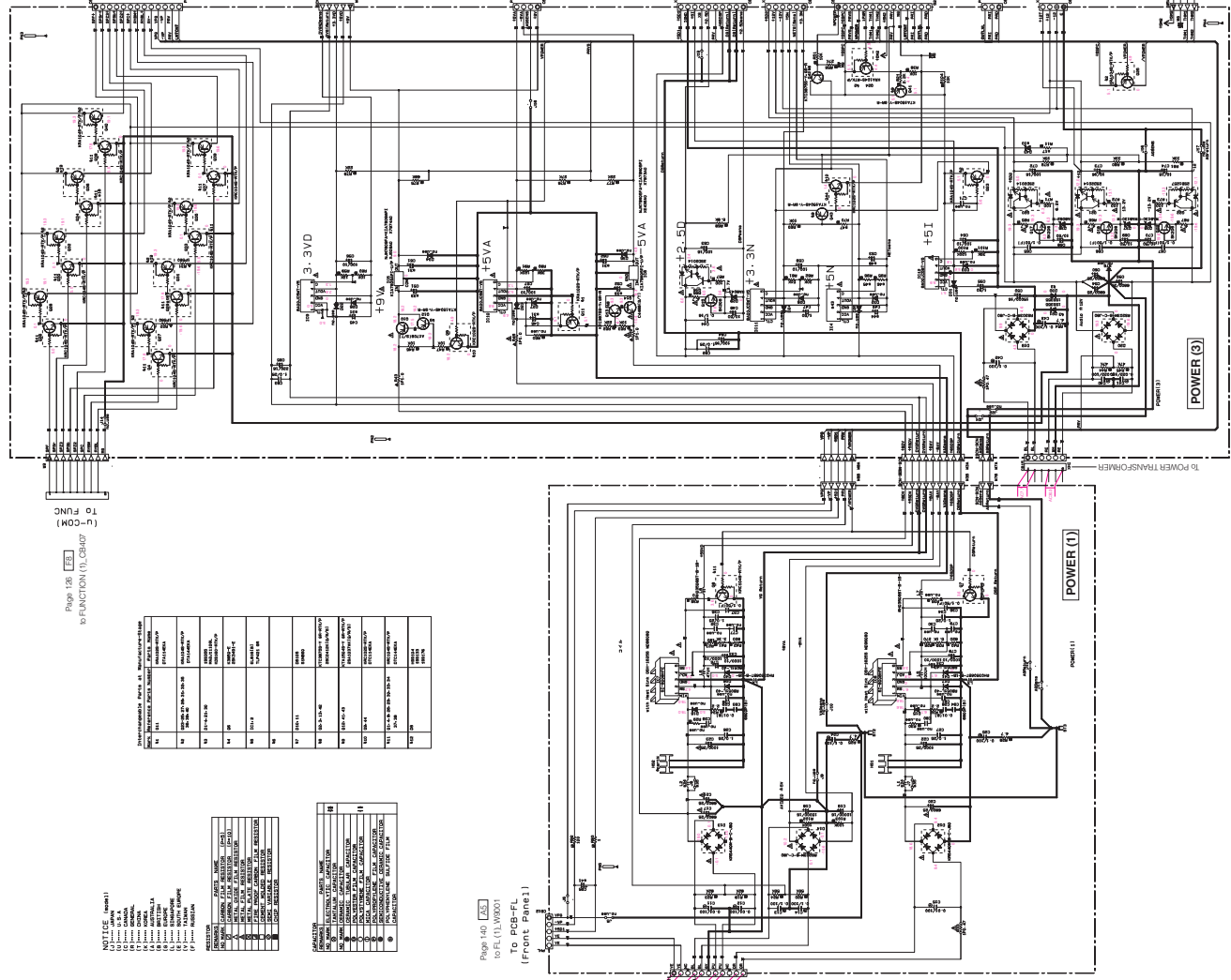

Page 126 [53]
 to FUNCTION (1), C9406

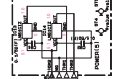

Page 126 [54]
 to FUNCTION (2), W9004
 (Pre Amp)

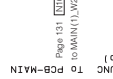

Page 131 [55]
 to MAIN (1), W271

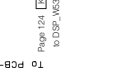

Page 131 [56]
 to DSP, W6501



Page 134 [57]
 to DSP, W6502

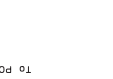

Page 134 [58]
 to DSP, W6502



Page 134 [59]
 to MAIN (4), W272



REGULATOR SPEC. LIST

NO.	REGULATOR	INPUT	OUTPUT	CURRENT	TEMPERATURE	PACKAGE	REMARKS
1	IC1	AC IN	5V	1.0A	0°C to 100°C	TO-18	REGULATOR
2	IC2	AC IN	3.3V	1.0A	0°C to 100°C	TO-18	REGULATOR
3	IC3	AC IN	5V	1.0A	0°C to 100°C	TO-18	REGULATOR
4	IC4	AC IN	3.3V	1.0A	0°C to 100°C	TO-18	REGULATOR
5	IC5	AC IN	5V	1.0A	0°C to 100°C	TO-18	REGULATOR
6	IC6	AC IN	3.3V	1.0A	0°C to 100°C	TO-18	REGULATOR
7	IC7	AC IN	5V	1.0A	0°C to 100°C	TO-18	REGULATOR
8	IC8	AC IN	3.3V	1.0A	0°C to 100°C	TO-18	REGULATOR
9	IC9	AC IN	5V	1.0A	0°C to 100°C	TO-18	REGULATOR
10	IC10	AC IN	3.3V	1.0A	0°C to 100°C	TO-18	REGULATOR
11	IC11	AC IN	5V	1.0A	0°C to 100°C	TO-18	REGULATOR
12	IC12	AC IN	3.3V	1.0A	0°C to 100°C	TO-18	REGULATOR
13	IC13	AC IN	5V	1.0A	0°C to 100°C	TO-18	REGULATOR
14	IC14	AC IN	3.3V	1.0A	0°C to 100°C	TO-18	REGULATOR
15	IC15	AC IN	5V	1.0A	0°C to 100°C	TO-18	REGULATOR
16	IC16	AC IN	3.3V	1.0A	0°C to 100°C	TO-18	REGULATOR
17	IC17	AC IN	5V	1.0A	0°C to 100°C	TO-18	REGULATOR
18	IC18	AC IN	3.3V	1.0A	0°C to 100°C	TO-18	REGULATOR
19	IC19	AC IN	5V	1.0A	0°C to 100°C	TO-18	REGULATOR
20	IC20	AC IN	3.3V	1.0A	0°C to 100°C	TO-18	REGULATOR

VOLTAGE SELECTOR

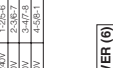

POWER (2)

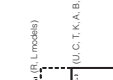

POWER (6)

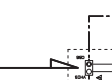

POWER (4)



POWER (5)

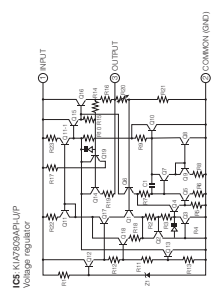
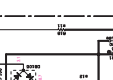

IC5 KA7500AULP
Voltage regulator

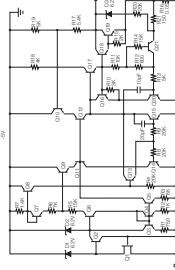

IC8 KA7500AULP
Voltage regulator

IC7 B 51000BFE
Voltage regulator

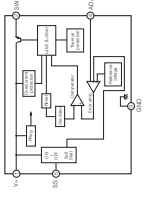

IC5 KA7500AULP
Voltage regulator

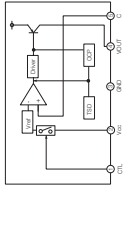

IC3 TDA1085P
Dual supply regulator

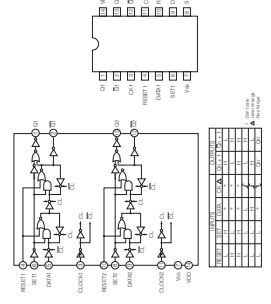

IC14 LMV02Z
Temperature sensor

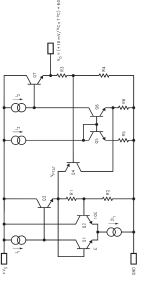

- 電圧は、内部抵抗 10MΩ の電圧計で測定したものです。
- 1 目的の異なる部品は、安全情報部品を示しています。部品の交換が必要となる場合。
- 1 目的の異なる部品は、安全情報部品を示しています。部品の交換が必要となる場合。
- 部品間の接続は、必ずしも図面通りではありません。

- ★ All voltages are measured with a 10MΩ DC electronic voltmeter.
- ★ Components having special characteristics are marked * and must be replaced with parts having specifications equal to those originally installed.
- ★ Schematic diagrams are subject to change without notice.

Page 140
OPERATION VOL.03/007

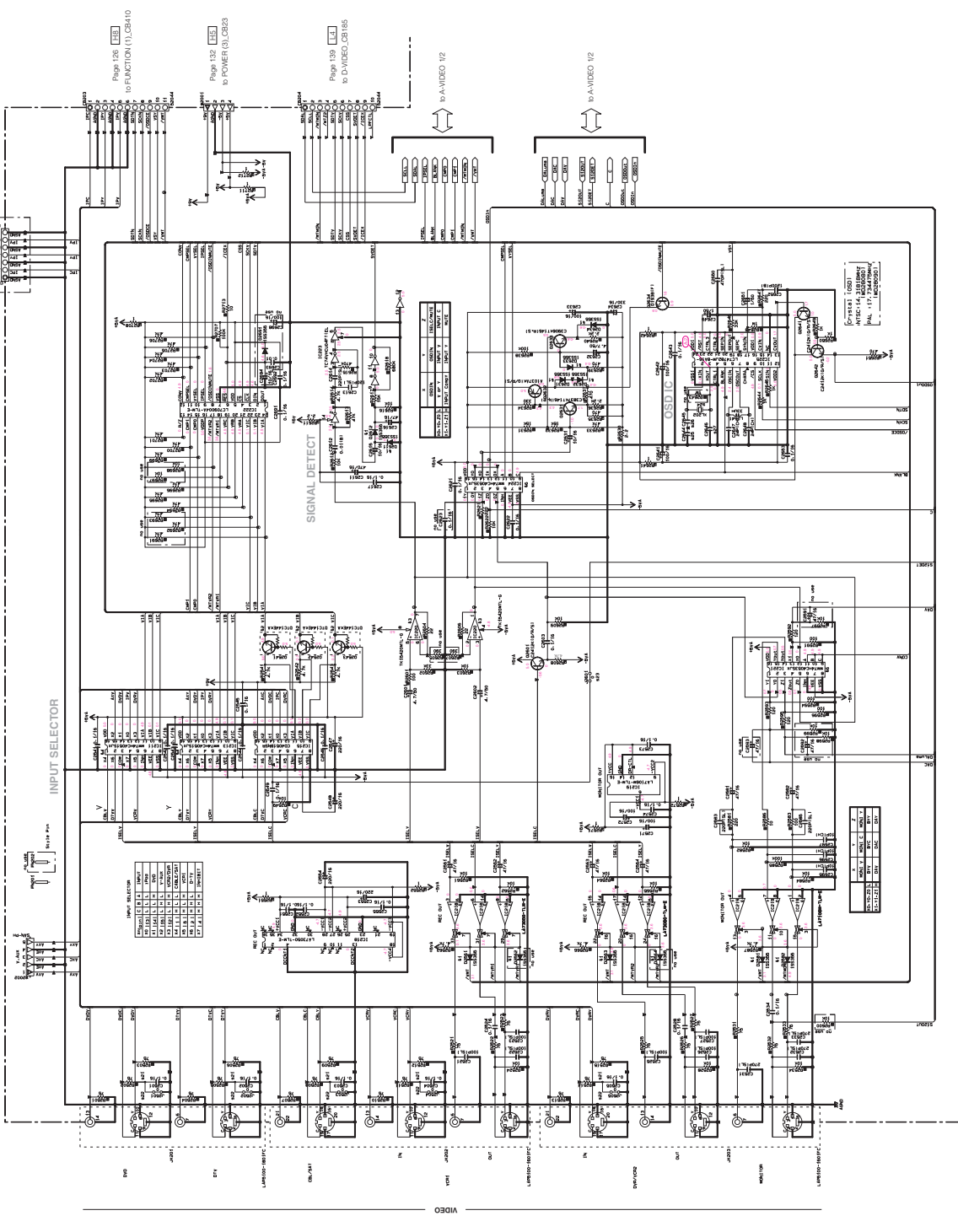

NOTICE (page 1)

RESISTOR

1	RESISTOR
2	RESISTOR
3	RESISTOR
4	RESISTOR
5	RESISTOR
6	RESISTOR
7	RESISTOR
8	RESISTOR
9	RESISTOR
10	RESISTOR
11	RESISTOR
12	RESISTOR
13	RESISTOR
14	RESISTOR
15	RESISTOR
16	RESISTOR
17	RESISTOR
18	RESISTOR
19	RESISTOR
20	RESISTOR
21	RESISTOR
22	RESISTOR
23	RESISTOR
24	RESISTOR
25	RESISTOR
26	RESISTOR
27	RESISTOR
28	RESISTOR
29	RESISTOR
30	RESISTOR
31	RESISTOR
32	RESISTOR
33	RESISTOR
34	RESISTOR
35	RESISTOR
36	RESISTOR
37	RESISTOR
38	RESISTOR
39	RESISTOR
40	RESISTOR
41	RESISTOR
42	RESISTOR
43	RESISTOR
44	RESISTOR
45	RESISTOR
46	RESISTOR
47	RESISTOR
48	RESISTOR
49	RESISTOR
50	RESISTOR
51	RESISTOR
52	RESISTOR
53	RESISTOR
54	RESISTOR
55	RESISTOR
56	RESISTOR
57	RESISTOR
58	RESISTOR
59	RESISTOR
60	RESISTOR
61	RESISTOR
62	RESISTOR
63	RESISTOR
64	RESISTOR
65	RESISTOR
66	RESISTOR
67	RESISTOR
68	RESISTOR
69	RESISTOR
70	RESISTOR
71	RESISTOR
72	RESISTOR
73	RESISTOR
74	RESISTOR
75	RESISTOR
76	RESISTOR
77	RESISTOR
78	RESISTOR
79	RESISTOR
80	RESISTOR
81	RESISTOR
82	RESISTOR
83	RESISTOR
84	RESISTOR
85	RESISTOR
86	RESISTOR
87	RESISTOR
88	RESISTOR
89	RESISTOR
90	RESISTOR
91	RESISTOR
92	RESISTOR
93	RESISTOR
94	RESISTOR
95	RESISTOR
96	RESISTOR
97	RESISTOR
98	RESISTOR
99	RESISTOR
100	RESISTOR

IC PARTS LIST

IC PARTS	IC PARTS	IC PARTS	IC PARTS
IC101	IC102	IC103	IC104
IC105	IC106	IC107	IC108
IC109	IC110	IC111	IC112
IC113	IC114	IC115	IC116
IC117	IC118	IC119	IC120
IC121	IC122	IC123	IC124
IC125	IC126	IC127	IC128
IC129	IC130	IC131	IC132
IC133	IC134	IC135	IC136
IC137	IC138	IC139	IC140
IC141	IC142	IC143	IC144
IC145	IC146	IC147	IC148
IC149	IC150	IC151	IC152
IC153	IC154	IC155	IC156
IC157	IC158	IC159	IC160
IC161	IC162	IC163	IC164
IC165	IC166	IC167	IC168
IC169	IC170	IC171	IC172
IC173	IC174	IC175	IC176
IC177	IC178	IC179	IC180
IC181	IC182	IC183	IC184
IC185	IC186	IC187	IC188
IC189	IC190	IC191	IC192
IC193	IC194	IC195	IC196
IC197	IC198	IC199	IC200

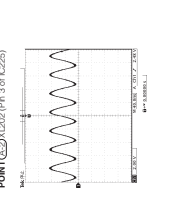
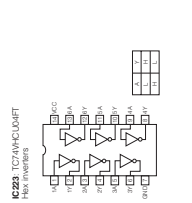
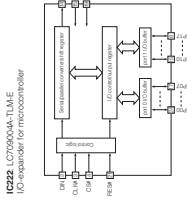
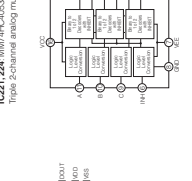
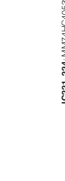
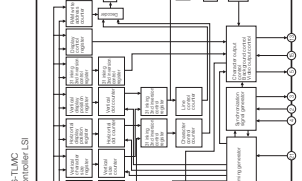
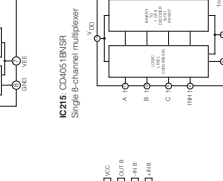
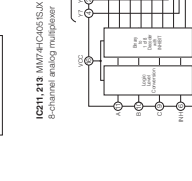
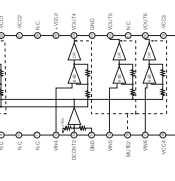
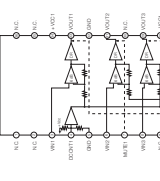

Pin No.	Symbol	Function
1	VCC	Power supply
2	Y	Y-axis video signal
3	V202	IO separator output
4	VCC	Power supply
5	VCC	Power supply
6	VCC	Power supply
7	VCC	Power supply
8	VCC	Power supply
9	VCC	Power supply
10	VCC	Power supply
11	VCC	Power supply
12	VCC	Power supply
13	VCC	Power supply
14	VCC	Power supply
15	VCC	Power supply
16	VCC	Power supply
17	VCC	Power supply
18	VCC	Power supply
19	VCC	Power supply
20	VCC	Power supply
21	VCC	Power supply
22	VCC	Power supply
23	VCC	Power supply
24	VCC	Power supply
25	VCC	Power supply
26	VCC	Power supply
27	VCC	Power supply
28	VCC	Power supply
29	VCC	Power supply
30	VCC	Power supply
31	VCC	Power supply
32	VCC	Power supply
33	VCC	Power supply
34	VCC	Power supply
35	VCC	Power supply
36	VCC	Power supply
37	VCC	Power supply
38	VCC	Power supply
39	VCC	Power supply
40	VCC	Power supply

Pin No.	Symbol	Function
1	VCC	Power supply
2	VCC	Power supply
3	VCC	Power supply
4	VCC	Power supply
5	VCC	Power supply
6	VCC	Power supply
7	VCC	Power supply
8	VCC	Power supply
9	VCC	Power supply
10	VCC	Power supply
11	VCC	Power supply
12	VCC	Power supply
13	VCC	Power supply
14	VCC	Power supply
15	VCC	Power supply
16	VCC	Power supply
17	VCC	Power supply
18	VCC	Power supply
19	VCC	Power supply
20	VCC	Power supply
21	VCC	Power supply
22	VCC	Power supply
23	VCC	Power supply
24	VCC	Power supply
25	VCC	Power supply
26	VCC	Power supply
27	VCC	Power supply
28	VCC	Power supply
29	VCC	Power supply
30	VCC	Power supply
31	VCC	Power supply
32	VCC	Power supply
33	VCC	Power supply
34	VCC	Power supply
35	VCC	Power supply
36	VCC	Power supply
37	VCC	Power supply
38	VCC	Power supply
39	VCC	Power supply
40	VCC	Power supply

Pin No.	Symbol	Function
1	VCC	Power supply
2	VCC	Power supply
3	VCC	Power supply
4	VCC	Power supply
5	VCC	Power supply
6	VCC	Power supply
7	VCC	Power supply
8	VCC	Power supply
9	VCC	Power supply
10	VCC	Power supply
11	VCC	Power supply
12	VCC	Power supply
13	VCC	Power supply
14	VCC	Power supply
15	VCC	Power supply
16	VCC	Power supply
17	VCC	Power supply
18	VCC	Power supply
19	VCC	Power supply
20	VCC	Power supply
21	VCC	Power supply
22	VCC	Power supply
23	VCC	Power supply
24	VCC	Power supply
25	VCC	Power supply
26	VCC	Power supply
27	VCC	Power supply
28	VCC	Power supply
29	VCC	Power supply
30	VCC	Power supply
31	VCC	Power supply
32	VCC	Power supply
33	VCC	Power supply
34	VCC	Power supply
35	VCC	Power supply
36	VCC	Power supply
37	VCC	Power supply
38	VCC	Power supply
39	VCC	Power supply
40	VCC	Power supply

* All voltages are measured with a 10MΩ DC electronic voltmeter.
 * Components having special characteristics are marked with a star (*).
 * Schematic diagram is subject to change without notice.

● 電圧は、外観抵抗10MΩの電圧計で測定したものです。
 ● *印のある部品は、特別な特性を示している部品を示しています。部品の交換がなされる場合、
 ● *印の部品は、特別な特性を示している部品を示しています。部品の交換がなされる場合、
 ● 本図面は標準部品図面です。内容が予告なく変更される場合がございます。

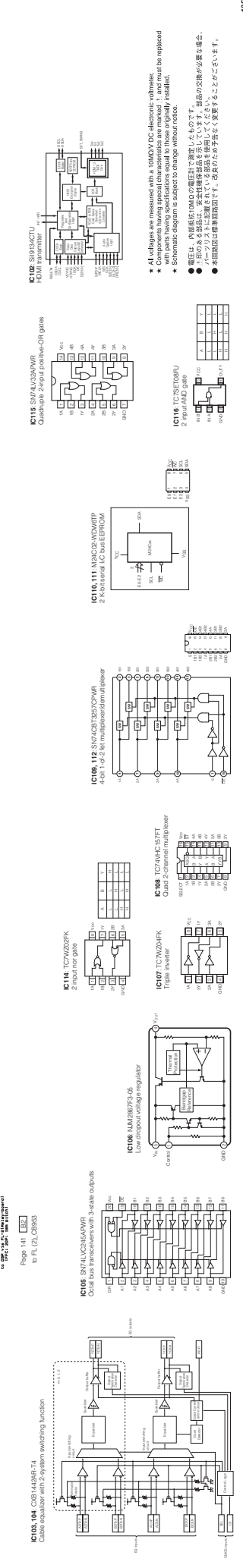
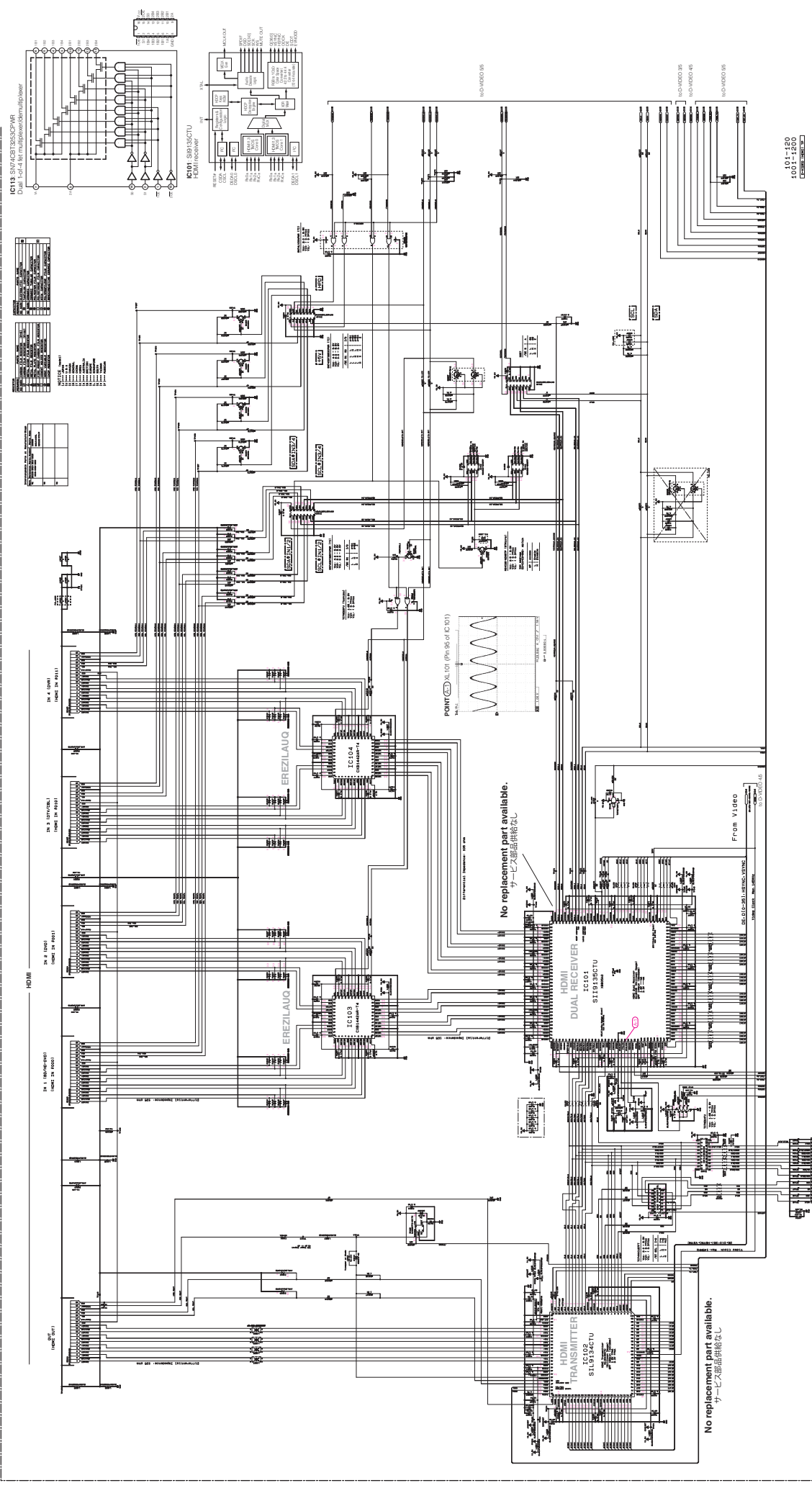

101-120
1001-1200
CSB00000000

Page 1/1
to FL (2) CSB00

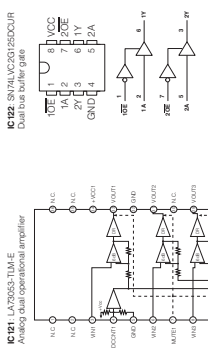

RESISTOR

1	RESISTOR	RESISTOR	RESISTOR	RESISTOR
2	RESISTOR	RESISTOR	RESISTOR	RESISTOR
3	RESISTOR	RESISTOR	RESISTOR	RESISTOR
4	RESISTOR	RESISTOR	RESISTOR	RESISTOR
5	RESISTOR	RESISTOR	RESISTOR	RESISTOR
6	RESISTOR	RESISTOR	RESISTOR	RESISTOR
7	RESISTOR	RESISTOR	RESISTOR	RESISTOR
8	RESISTOR	RESISTOR	RESISTOR	RESISTOR
9	RESISTOR	RESISTOR	RESISTOR	RESISTOR
0	RESISTOR	RESISTOR	RESISTOR	RESISTOR
A	RESISTOR	RESISTOR	RESISTOR	RESISTOR
B	RESISTOR	RESISTOR	RESISTOR	RESISTOR
C	RESISTOR	RESISTOR	RESISTOR	RESISTOR
D	RESISTOR	RESISTOR	RESISTOR	RESISTOR
E	RESISTOR	RESISTOR	RESISTOR	RESISTOR
F	RESISTOR	RESISTOR	RESISTOR	RESISTOR
G	RESISTOR	RESISTOR	RESISTOR	RESISTOR
H	RESISTOR	RESISTOR	RESISTOR	RESISTOR
I	RESISTOR	RESISTOR	RESISTOR	RESISTOR
J	RESISTOR	RESISTOR	RESISTOR	RESISTOR
K	RESISTOR	RESISTOR	RESISTOR	RESISTOR
L	RESISTOR	RESISTOR	RESISTOR	RESISTOR
M	RESISTOR	RESISTOR	RESISTOR	RESISTOR
N	RESISTOR	RESISTOR	RESISTOR	RESISTOR
O	RESISTOR	RESISTOR	RESISTOR	RESISTOR
P	RESISTOR	RESISTOR	RESISTOR	RESISTOR
Q	RESISTOR	RESISTOR	RESISTOR	RESISTOR
R	RESISTOR	RESISTOR	RESISTOR	RESISTOR
S	RESISTOR	RESISTOR	RESISTOR	RESISTOR
T	RESISTOR	RESISTOR	RESISTOR	RESISTOR
U	RESISTOR	RESISTOR	RESISTOR	RESISTOR
V	RESISTOR	RESISTOR	RESISTOR	RESISTOR
W	RESISTOR	RESISTOR	RESISTOR	RESISTOR
X	RESISTOR	RESISTOR	RESISTOR	RESISTOR
Y	RESISTOR	RESISTOR	RESISTOR	RESISTOR
Z	RESISTOR	RESISTOR	RESISTOR	RESISTOR

RESISTOR PARTS NAME

1	RESISTOR	RESISTOR	RESISTOR	RESISTOR
2	RESISTOR	RESISTOR	RESISTOR	RESISTOR
3	RESISTOR	RESISTOR	RESISTOR	RESISTOR
4	RESISTOR	RESISTOR	RESISTOR	RESISTOR
5	RESISTOR	RESISTOR	RESISTOR	RESISTOR
6	RESISTOR	RESISTOR	RESISTOR	RESISTOR
7	RESISTOR	RESISTOR	RESISTOR	RESISTOR
8	RESISTOR	RESISTOR	RESISTOR	RESISTOR
9	RESISTOR	RESISTOR	RESISTOR	RESISTOR
0	RESISTOR	RESISTOR	RESISTOR	RESISTOR
A	RESISTOR	RESISTOR	RESISTOR	RESISTOR
B	RESISTOR	RESISTOR	RESISTOR	RESISTOR
C	RESISTOR	RESISTOR	RESISTOR	RESISTOR
D	RESISTOR	RESISTOR	RESISTOR	RESISTOR
E	RESISTOR	RESISTOR	RESISTOR	RESISTOR
F	RESISTOR	RESISTOR	RESISTOR	RESISTOR
G	RESISTOR	RESISTOR	RESISTOR	RESISTOR
H	RESISTOR	RESISTOR	RESISTOR	RESISTOR
I	RESISTOR	RESISTOR	RESISTOR	RESISTOR
J	RESISTOR	RESISTOR	RESISTOR	RESISTOR
K	RESISTOR	RESISTOR	RESISTOR	RESISTOR
L	RESISTOR	RESISTOR	RESISTOR	RESISTOR
M	RESISTOR	RESISTOR	RESISTOR	RESISTOR
N	RESISTOR	RESISTOR	RESISTOR	RESISTOR
O	RESISTOR	RESISTOR	RESISTOR	RESISTOR
P	RESISTOR	RESISTOR	RESISTOR	RESISTOR
Q	RESISTOR	RESISTOR	RESISTOR	RESISTOR
R	RESISTOR	RESISTOR	RESISTOR	RESISTOR
S	RESISTOR	RESISTOR	RESISTOR	RESISTOR
T	RESISTOR	RESISTOR	RESISTOR	RESISTOR
U	RESISTOR	RESISTOR	RESISTOR	RESISTOR
V	RESISTOR	RESISTOR	RESISTOR	RESISTOR
W	RESISTOR	RESISTOR	RESISTOR	RESISTOR
X	RESISTOR	RESISTOR	RESISTOR	RESISTOR
Y	RESISTOR	RESISTOR	RESISTOR	RESISTOR
Z	RESISTOR	RESISTOR	RESISTOR	RESISTOR

IC103 ADV7348BZT
Multiformat video encoder

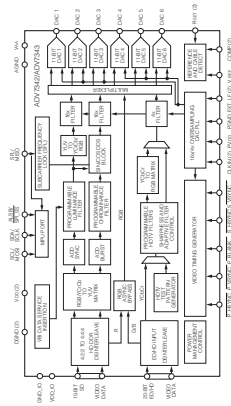

IC124 ADV7401BZT-80
Multiformat SDTV/DTV video decoder and RGB graphics digitizer

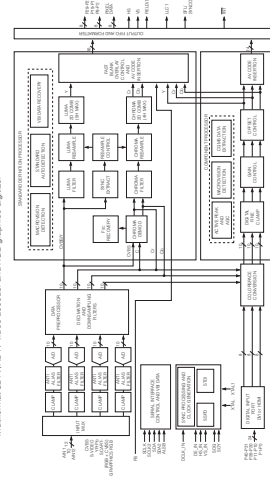

NOTICE (IMPORTANT)

- (U) U.S.A.
- (S) GENERAL
- (T) CHINA
- (A) AUSTRALIA
- (B) BRITISH
- (L) SINGAPORE
- (D) JAPAN
- (P) RUSSIAN

121-140
1201-1400
Video Encoder
Video Decoder

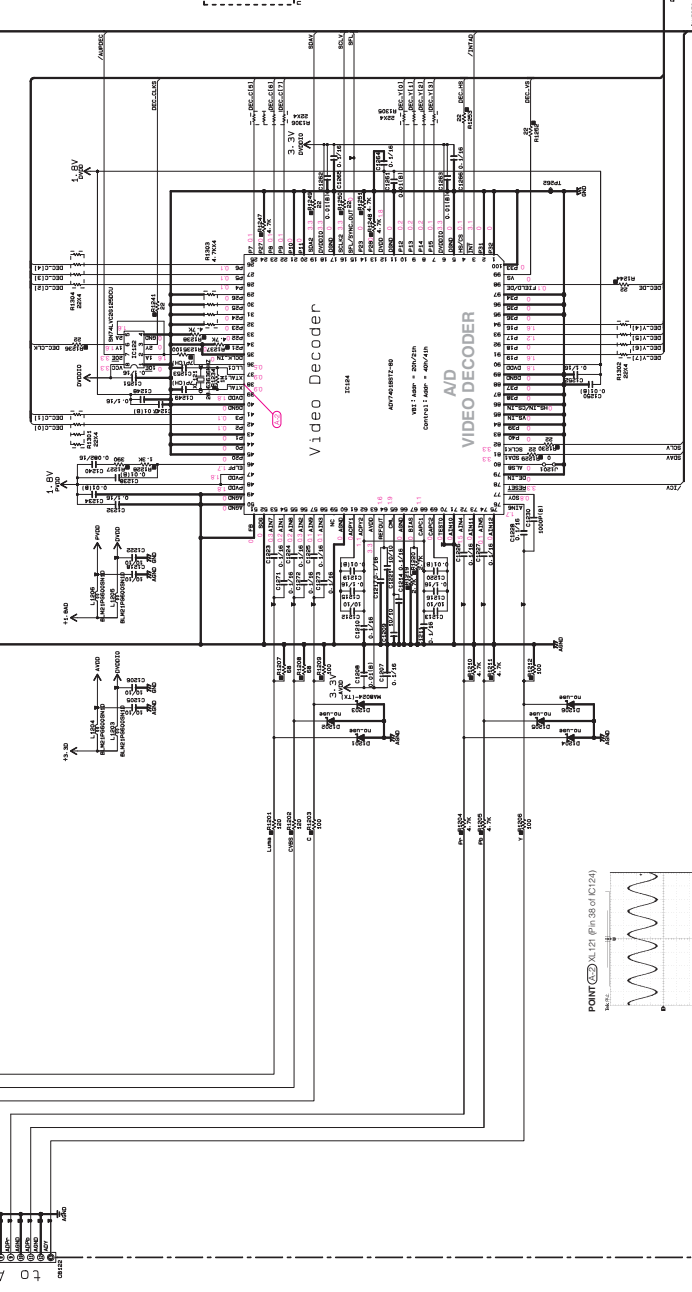
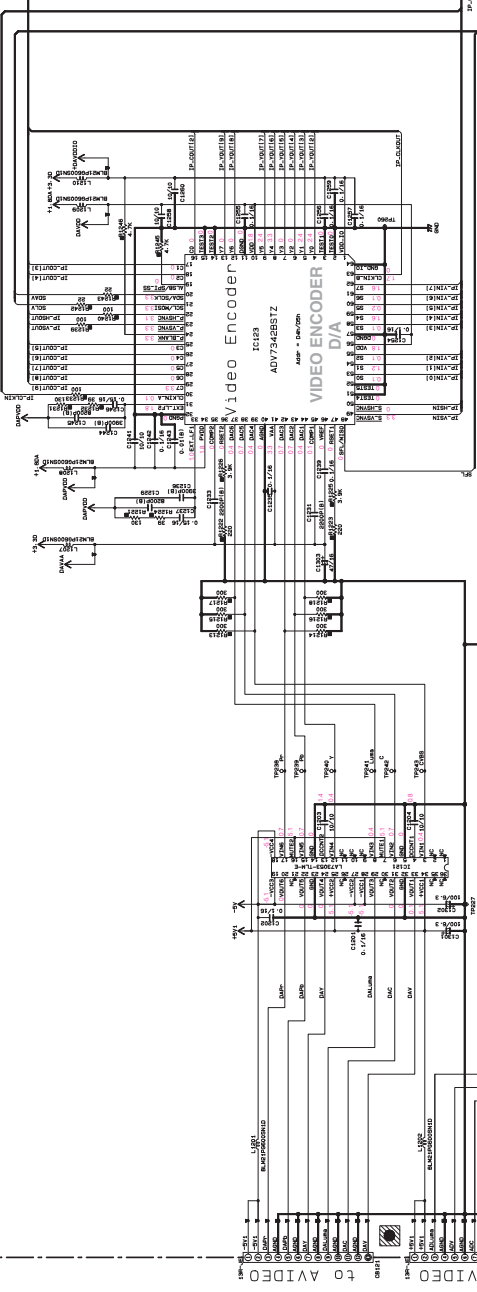

● All voltages are measured with a 10MΩVDC electronic voltmeter.
 ● Components having special characteristics are marked with a triangle.
 ● Parts having specifications equal to those originally installed.
 ● Schematic diagram is subject to change without notice.

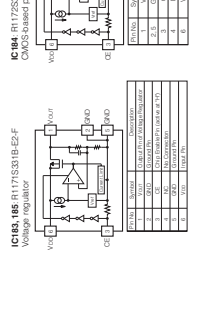
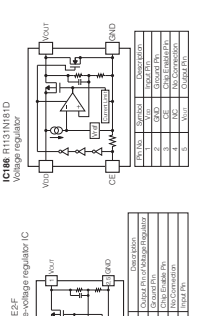
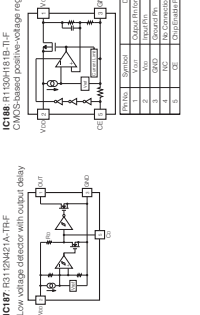
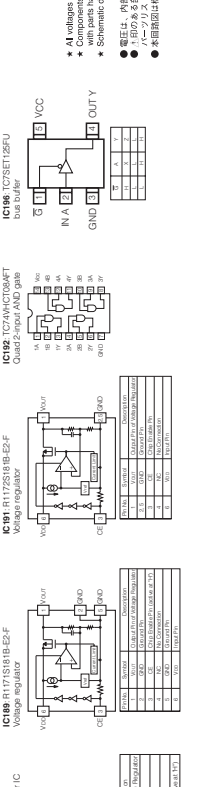
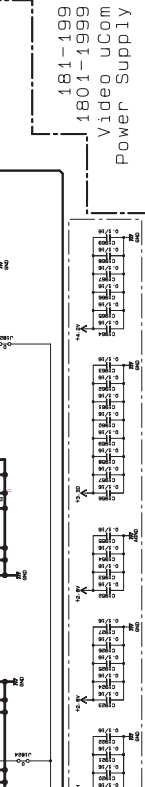
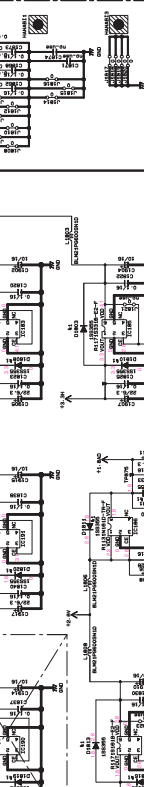
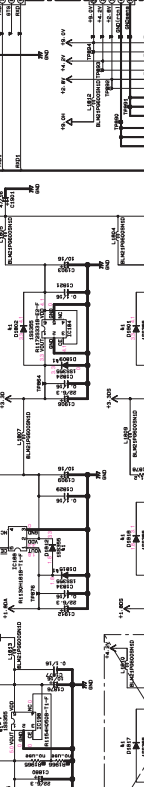
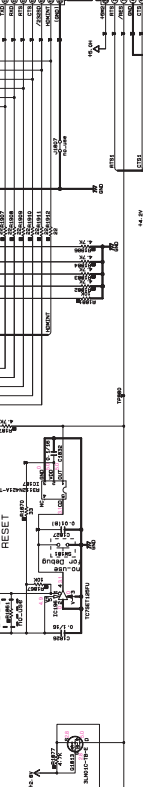
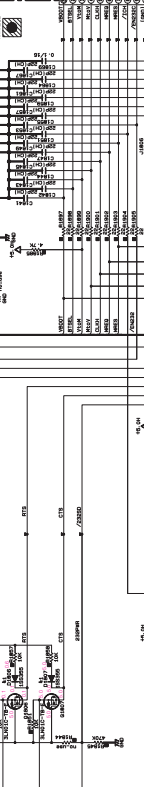
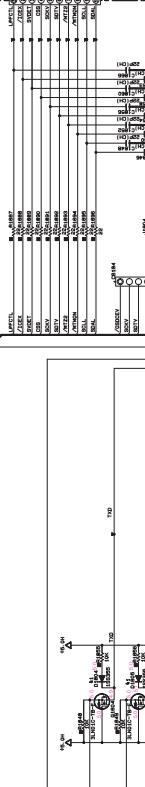
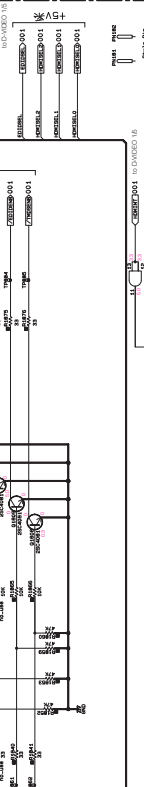
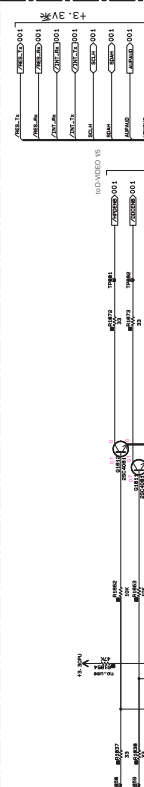
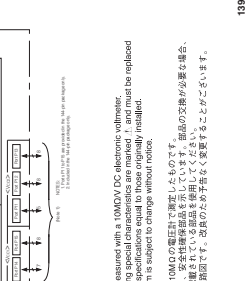
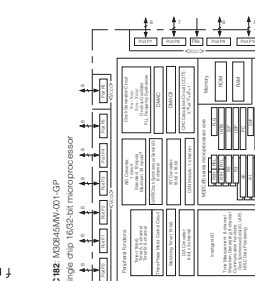
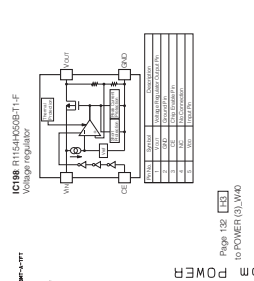
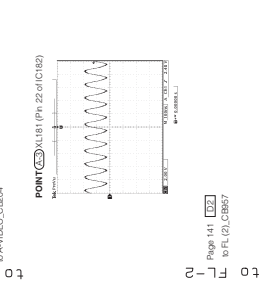
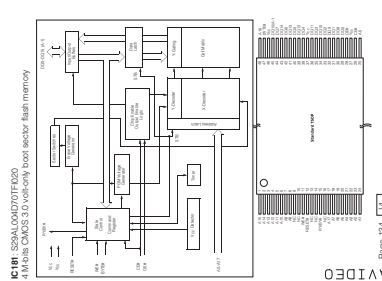
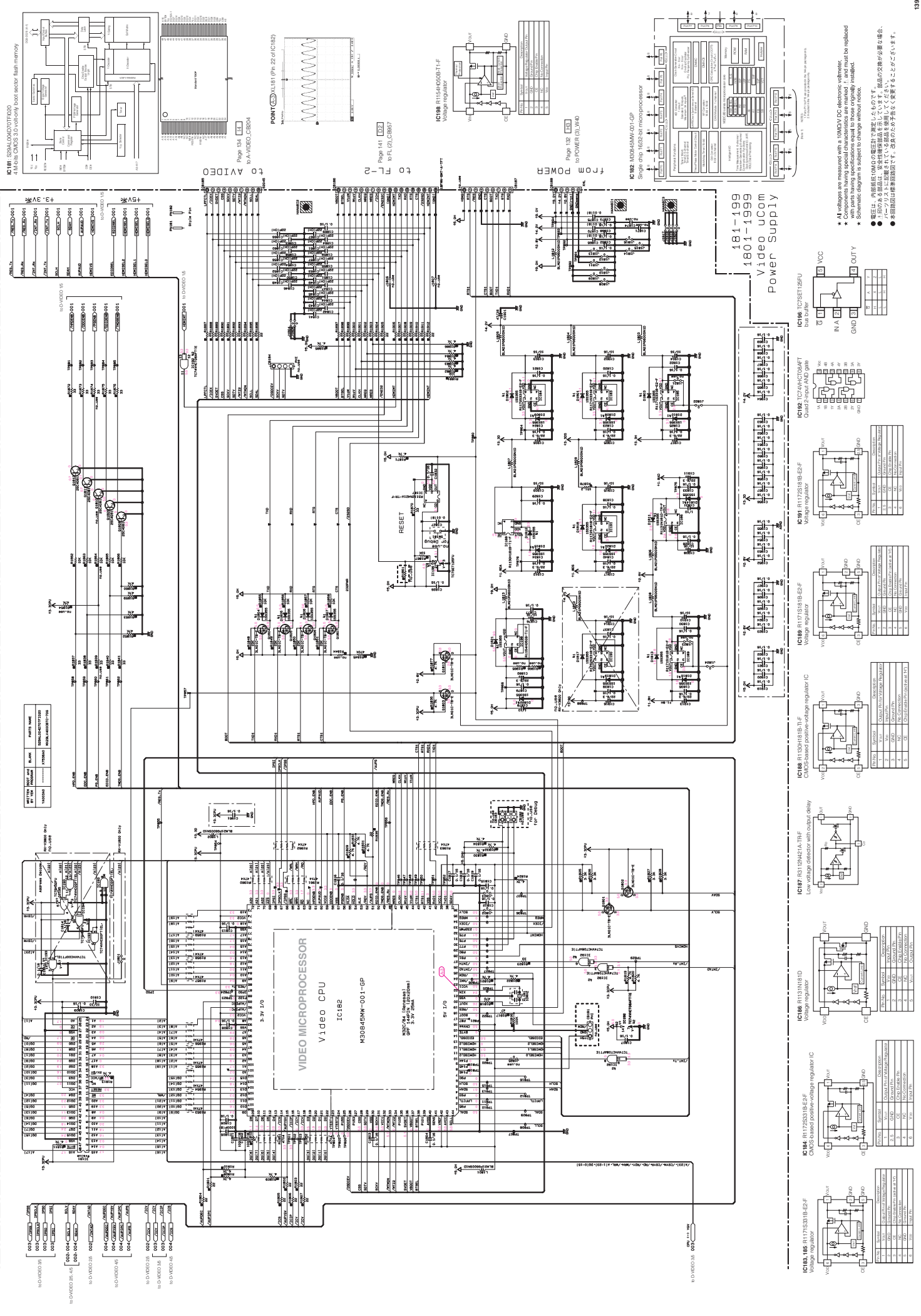

181-199
1801-1999
Video Ucom
Power Supply

● 電圧は、内部抵抗(10MΩ)の状態で測定したものです。
● 1: 目的のある部品は、必ず仕様書で示されています。部品の交換が必須な場合は、本回路図は正確な図面です。交換の必要がなくなり交換することができません。

● AI packages are measured with a 10MΩV DC electronic voltmeter. ● With parts having specifications equal to those originally installed. ● Schematic diagram is subject to change without notice.

● 電圧は、内部抵抗(10MΩ)の状態で測定したものです。
● 1: 目的のある部品は、必ず仕様書で示されています。部品の交換が必須な場合は、本回路図は正確な図面です。交換の必要がなくなり交換することができません。

● AI packages are measured with a 10MΩV DC electronic voltmeter. ● With parts having specifications equal to those originally installed. ● Schematic diagram is subject to change without notice.

● 電圧は、内部抵抗(10MΩ)の状態で測定したものです。
● 1: 目的のある部品は、必ず仕様書で示されています。部品の交換が必須な場合は、本回路図は正確な図面です。交換の必要がなくなり交換することができません。

● AI packages are measured with a 10MΩV DC electronic voltmeter. ● With parts having specifications equal to those originally installed. ● Schematic diagram is subject to change without notice.

● 電圧は、内部抵抗(10MΩ)の状態で測定したものです。
● 1: 目的のある部品は、必ず仕様書で示されています。部品の交換が必須な場合は、本回路図は正確な図面です。交換の必要がなくなり交換することができません。

● AI packages are measured with a 10MΩV DC electronic voltmeter. ● With parts having specifications equal to those originally installed. ● Schematic diagram is subject to change without notice.

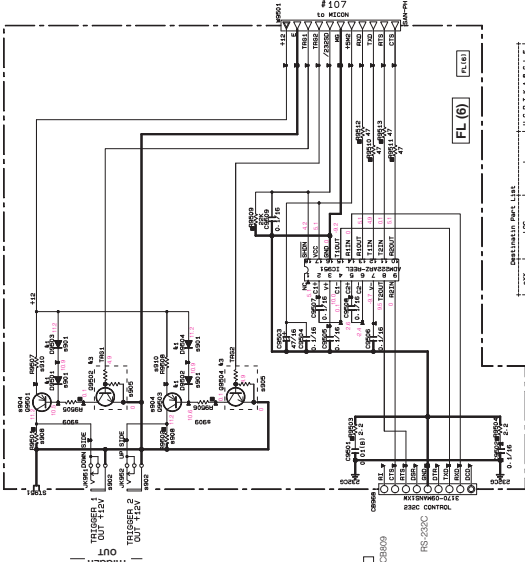

DESTINATION PART LIST

QTY	REF	DESCRIPTION	MANUFACTURE
1	1001	RESISTOR	10000000
1	1002	RESISTOR	10000000
1	1003	RESISTOR	10000000
1	1004	RESISTOR	10000000
1	1005	RESISTOR	10000000
1	1006	RESISTOR	10000000
1	1007	RESISTOR	10000000
1	1008	RESISTOR	10000000
1	1009	RESISTOR	10000000
1	1010	RESISTOR	10000000
1	1011	RESISTOR	10000000
1	1012	RESISTOR	10000000
1	1013	RESISTOR	10000000
1	1014	RESISTOR	10000000
1	1015	RESISTOR	10000000
1	1016	RESISTOR	10000000
1	1017	RESISTOR	10000000
1	1018	RESISTOR	10000000
1	1019	RESISTOR	10000000
1	1020	RESISTOR	10000000
1	1021	RESISTOR	10000000
1	1022	RESISTOR	10000000
1	1023	RESISTOR	10000000
1	1024	RESISTOR	10000000
1	1025	RESISTOR	10000000
1	1026	RESISTOR	10000000
1	1027	RESISTOR	10000000
1	1028	RESISTOR	10000000
1	1029	RESISTOR	10000000
1	1030	RESISTOR	10000000
1	1031	RESISTOR	10000000
1	1032	RESISTOR	10000000
1	1033	RESISTOR	10000000
1	1034	RESISTOR	10000000
1	1035	RESISTOR	10000000
1	1036	RESISTOR	10000000
1	1037	RESISTOR	10000000
1	1038	RESISTOR	10000000
1	1039	RESISTOR	10000000
1	1040	RESISTOR	10000000
1	1041	RESISTOR	10000000
1	1042	RESISTOR	10000000
1	1043	RESISTOR	10000000
1	1044	RESISTOR	10000000
1	1045	RESISTOR	10000000
1	1046	RESISTOR	10000000
1	1047	RESISTOR	10000000
1	1048	RESISTOR	10000000
1	1049	RESISTOR	10000000
1	1050	RESISTOR	10000000
1	1051	RESISTOR	10000000
1	1052	RESISTOR	10000000
1	1053	RESISTOR	10000000
1	1054	RESISTOR	10000000
1	1055	RESISTOR	10000000
1	1056	RESISTOR	10000000
1	1057	RESISTOR	10000000
1	1058	RESISTOR	10000000
1	1059	RESISTOR	10000000
1	1060	RESISTOR	10000000
1	1061	RESISTOR	10000000
1	1062	RESISTOR	10000000
1	1063	RESISTOR	10000000
1	1064	RESISTOR	10000000
1	1065	RESISTOR	10000000
1	1066	RESISTOR	10000000
1	1067	RESISTOR	10000000
1	1068	RESISTOR	10000000
1	1069	RESISTOR	10000000
1	1070	RESISTOR	10000000
1	1071	RESISTOR	10000000
1	1072	RESISTOR	10000000
1	1073	RESISTOR	10000000
1	1074	RESISTOR	10000000
1	1075	RESISTOR	10000000
1	1076	RESISTOR	10000000
1	1077	RESISTOR	10000000
1	1078	RESISTOR	10000000
1	1079	RESISTOR	10000000
1	1080	RESISTOR	10000000
1	1081	RESISTOR	10000000
1	1082	RESISTOR	10000000
1	1083	RESISTOR	10000000
1	1084	RESISTOR	10000000
1	1085	RESISTOR	10000000
1	1086	RESISTOR	10000000
1	1087	RESISTOR	10000000
1	1088	RESISTOR	10000000
1	1089	RESISTOR	10000000
1	1090	RESISTOR	10000000
1	1091	RESISTOR	10000000
1	1092	RESISTOR	10000000
1	1093	RESISTOR	10000000
1	1094	RESISTOR	10000000
1	1095	RESISTOR	10000000
1	1096	RESISTOR	10000000
1	1097	RESISTOR	10000000
1	1098	RESISTOR	10000000
1	1099	RESISTOR	10000000
1	1100	RESISTOR	10000000

Interchangeable Parts at Manufacture Stage

QTY	REF	DESCRIPTION	MANUFACTURE
1	1001	RESISTOR	10000000
1	1002	RESISTOR	10000000
1	1003	RESISTOR	10000000
1	1004	RESISTOR	10000000
1	1005	RESISTOR	10000000
1	1006	RESISTOR	10000000
1	1007	RESISTOR	10000000
1	1008	RESISTOR	10000000
1	1009	RESISTOR	10000000
1	1010	RESISTOR	10000000
1	1011	RESISTOR	10000000
1	1012	RESISTOR	10000000
1	1013	RESISTOR	10000000
1	1014	RESISTOR	10000000
1	1015	RESISTOR	10000000
1	1016	RESISTOR	10000000
1	1017	RESISTOR	10000000
1	1018	RESISTOR	10000000
1	1019	RESISTOR	10000000
1	1020	RESISTOR	10000000
1	1021	RESISTOR	10000000
1	1022	RESISTOR	10000000
1	1023	RESISTOR	10000000
1	1024	RESISTOR	10000000
1	1025	RESISTOR	10000000
1	1026	RESISTOR	10000000
1	1027	RESISTOR	10000000
1	1028	RESISTOR	10000000
1	1029	RESISTOR	10000000
1	1030	RESISTOR	10000000
1	1031	RESISTOR	10000000
1	1032	RESISTOR	10000000
1	1033	RESISTOR	10000000
1	1034	RESISTOR	10000000
1	1035	RESISTOR	10000000
1	1036	RESISTOR	10000000
1	1037	RESISTOR	10000000
1	1038	RESISTOR	10000000
1	1039	RESISTOR	10000000
1	1040	RESISTOR	10000000
1	1041	RESISTOR	10000000
1	1042	RESISTOR	10000000
1	1043	RESISTOR	10000000
1	1044	RESISTOR	10000000
1	1045	RESISTOR	10000000
1	1046	RESISTOR	10000000
1	1047	RESISTOR	10000000
1	1048	RESISTOR	10000000
1	1049	RESISTOR	10000000
1	1050	RESISTOR	10000000
1	1051	RESISTOR	10000000
1	1052	RESISTOR	10000000
1	1053	RESISTOR	10000000
1	1054	RESISTOR	10000000
1	1055	RESISTOR	10000000
1	1056	RESISTOR	10000000
1	1057	RESISTOR	10000000
1	1058	RESISTOR	10000000
1	1059	RESISTOR	10000000
1	1060	RESISTOR	10000000
1	1061	RESISTOR	10000000
1	1062	RESISTOR	10000000
1	1063	RESISTOR	10000000
1	1064	RESISTOR	10000000
1	1065	RESISTOR	10000000
1	1066	RESISTOR	10000000
1	1067	RESISTOR	10000000
1	1068	RESISTOR	10000000
1	1069	RESISTOR	10000000
1	1070	RESISTOR	10000000
1	1071	RESISTOR	10000000
1	1072	RESISTOR	10000000
1	1073	RESISTOR	10000000
1	1074	RESISTOR	10000000
1	1075	RESISTOR	10000000
1	1076	RESISTOR	10000000
1	1077	RESISTOR	10000000
1	1078	RESISTOR	10000000
1	1079	RESISTOR	10000000
1	1080	RESISTOR	10000000
1	1081	RESISTOR	10000000
1	1082	RESISTOR	10000000
1	1083	RESISTOR	10000000
1	1084	RESISTOR	10000000
1	1085	RESISTOR	10000000
1	1086	RESISTOR	10000000
1	1087	RESISTOR	10000000
1	1088	RESISTOR	10000000
1	1089	RESISTOR	10000000
1	1090	RESISTOR	10000000
1	1091	RESISTOR	10000000
1	1092	RESISTOR	10000000
1	1093	RESISTOR	10000000
1	1094	RESISTOR	10000000
1	1095	RESISTOR	10000000
1	1096	RESISTOR	10000000
1	1097	RESISTOR	10000000
1	1098	RESISTOR	10000000
1	1099	RESISTOR	10000000
1	1100	RESISTOR	10000000

Page 130 [L3] IS OPERATION (1) CB812

Page 130 [L3] IS OPERATION (1) CB812

Page 130 [L3] IS OPERATION (1) CB812

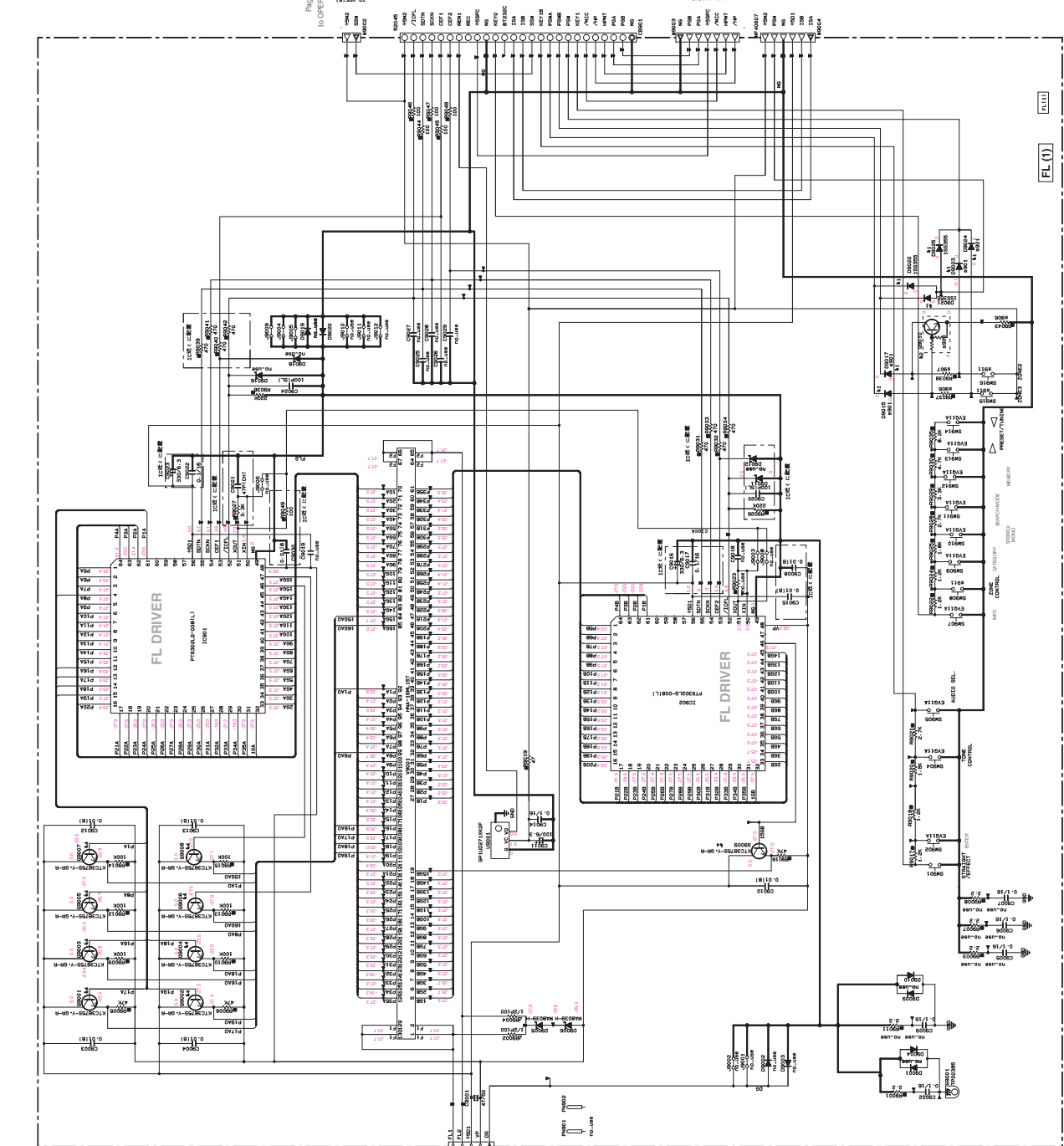

RESISTOR

REMARKS	PARTS NAME	UNIT
①	NON-INDUCTIVE FILM RESISTOR	Ω
②	GENERAL PURPOSE CARBON FILM RESISTOR	Ω
③	METAL OXIDE FILM RESISTOR	Ω
④	METAL FILM RESISTOR	Ω
⑤	FLAME PROOF CARBON FILM RESISTOR	Ω
⑥	GENERAL PURPOSE RESISTOR	Ω
⑦	OHM RESISTOR	Ω

CAPACITOR

REMARKS	PARTS NAME	UNIT
①	NON-INDUCTIVE FILM CAPACITOR	μF
②	GENERAL PURPOSE ELECTROLYTIC CAPACITOR	μF
③	NON-INDUCTIVE FILM CAPACITOR	μF
④	NON-INDUCTIVE FILM CAPACITOR	μF
⑤	NON-INDUCTIVE FILM CAPACITOR	μF
⑥	NON-INDUCTIVE FILM CAPACITOR	μF
⑦	NON-INDUCTIVE FILM CAPACITOR	μF
⑧	NON-INDUCTIVE FILM CAPACITOR	μF
⑨	NON-INDUCTIVE FILM CAPACITOR	μF
⑩	NON-INDUCTIVE FILM CAPACITOR	μF
⑪	NON-INDUCTIVE FILM CAPACITOR	μF
⑫	NON-INDUCTIVE FILM CAPACITOR	μF
⑬	NON-INDUCTIVE FILM CAPACITOR	μF
⑭	NON-INDUCTIVE FILM CAPACITOR	μF
⑮	NON-INDUCTIVE FILM CAPACITOR	μF
⑯	NON-INDUCTIVE FILM CAPACITOR	μF
⑰	NON-INDUCTIVE FILM CAPACITOR	μF
⑱	NON-INDUCTIVE FILM CAPACITOR	μF
⑲	NON-INDUCTIVE FILM CAPACITOR	μF
⑳	NON-INDUCTIVE FILM CAPACITOR	μF
㉑	NON-INDUCTIVE FILM CAPACITOR	μF
㉒	NON-INDUCTIVE FILM CAPACITOR	μF
㉓	NON-INDUCTIVE FILM CAPACITOR	μF
㉔	NON-INDUCTIVE FILM CAPACITOR	μF
㉕	NON-INDUCTIVE FILM CAPACITOR	μF
㉖	NON-INDUCTIVE FILM CAPACITOR	μF
㉗	NON-INDUCTIVE FILM CAPACITOR	μF
㉘	NON-INDUCTIVE FILM CAPACITOR	μF
㉙	NON-INDUCTIVE FILM CAPACITOR	μF
㉚	NON-INDUCTIVE FILM CAPACITOR	μF
㉛	NON-INDUCTIVE FILM CAPACITOR	μF
㉜	NON-INDUCTIVE FILM CAPACITOR	μF
㉝	NON-INDUCTIVE FILM CAPACITOR	μF
㉞	NON-INDUCTIVE FILM CAPACITOR	μF
㉟	NON-INDUCTIVE FILM CAPACITOR	μF
㊱	NON-INDUCTIVE FILM CAPACITOR	μF
㊲	NON-INDUCTIVE FILM CAPACITOR	μF
㊳	NON-INDUCTIVE FILM CAPACITOR	μF
㊴	NON-INDUCTIVE FILM CAPACITOR	μF
㊵	NON-INDUCTIVE FILM CAPACITOR	μF
㊶	NON-INDUCTIVE FILM CAPACITOR	μF
㊷	NON-INDUCTIVE FILM CAPACITOR	μF
㊸	NON-INDUCTIVE FILM CAPACITOR	μF
㊹	NON-INDUCTIVE FILM CAPACITOR	μF
㊺	NON-INDUCTIVE FILM CAPACITOR	μF
㊻	NON-INDUCTIVE FILM CAPACITOR	μF
㊼	NON-INDUCTIVE FILM CAPACITOR	μF
㊽	NON-INDUCTIVE FILM CAPACITOR	μF
㊾	NON-INDUCTIVE FILM CAPACITOR	μF
㊿	NON-INDUCTIVE FILM CAPACITOR	μF

NOTICE (note 1)

(J)..... JAPAN
(C)..... CANADA
(R)..... GENERAL
K..... KOREA
(A)..... AUSTRALIA
(S)..... SINGAPORE
(E)..... SOUTH
(F)..... RUSSIAN

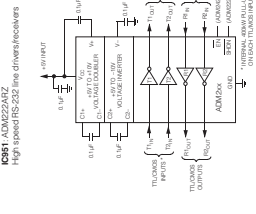
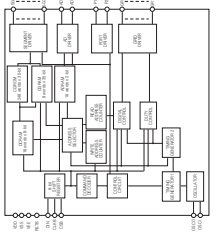

* All voltages are measured with a 10MΩ DC electronic voltmeter.
* Components having special characteristics are marked with a triangle.
* Schematic diagram is subject to change without notice.

● 電圧は、外周回路VMOの電圧で測定したものです。部品の交換が必要の場合、
● ①印のある部品は、特別な特性を示している部品を使用してください。
● ②印のある部品は、特別な特性を示している部品を使用してください。
● ③印のある部品は、特別な特性を示している部品を使用してください。

N
M
L
K
J
I
H
G
F
E
D
C
B
A

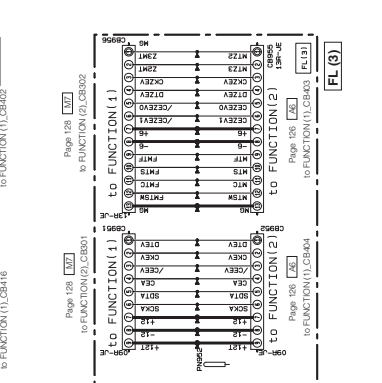
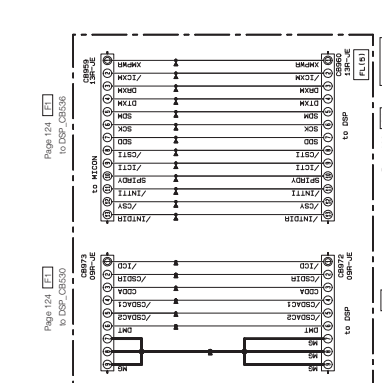
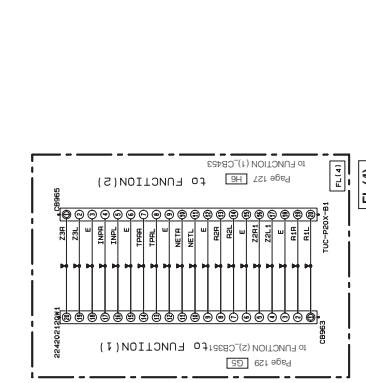
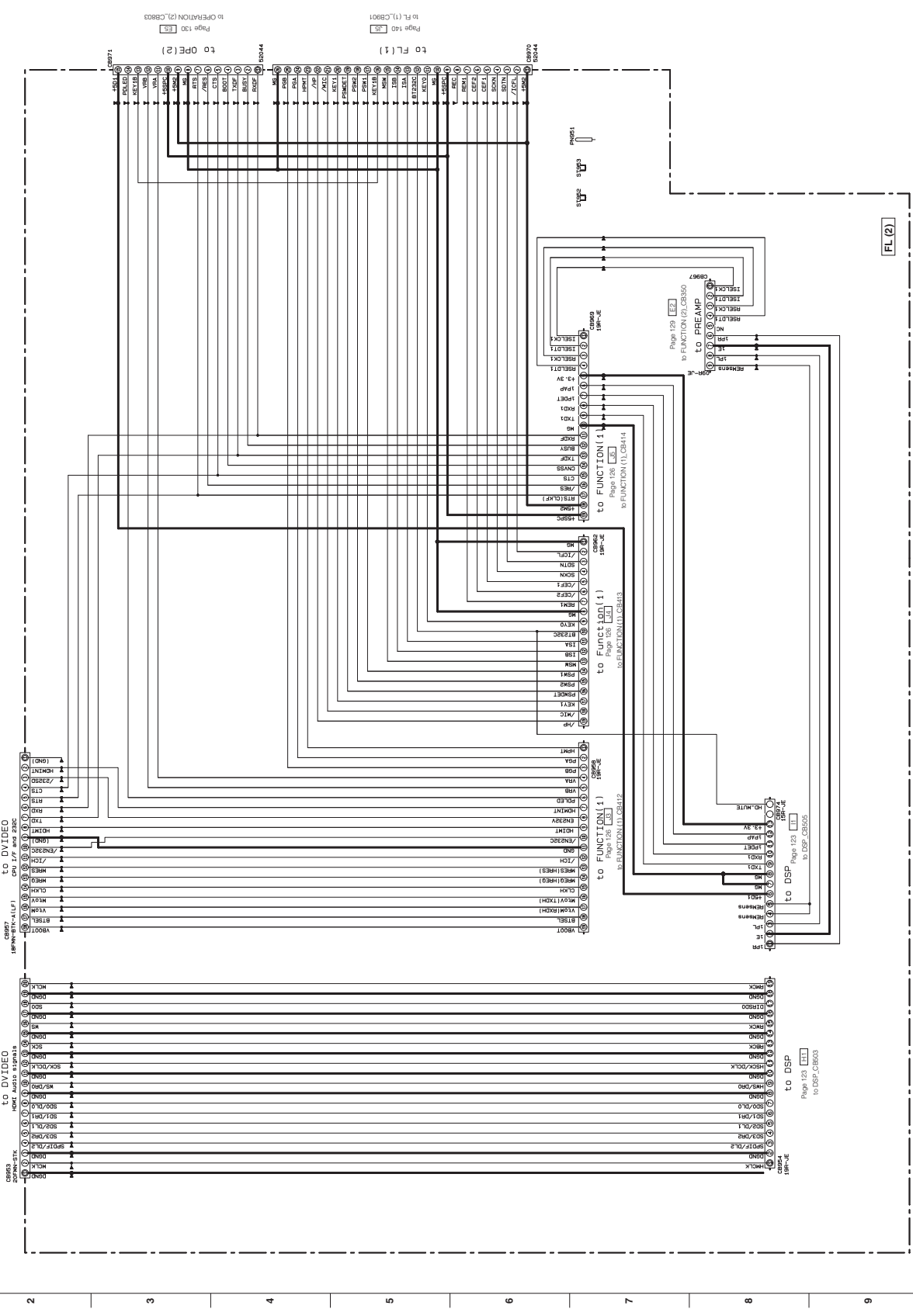

- * All voltages are measured with a 10MΩVDC electronic voltmeter.
- * Components having special characteristics are marked ♯, and must be replaced with components of the same type.
- * Schematic diagram is subject to change without notice.

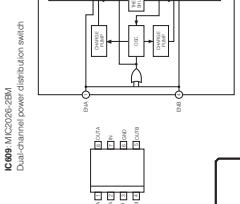
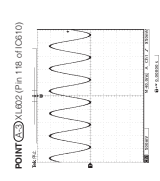
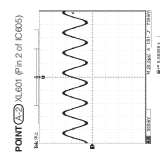
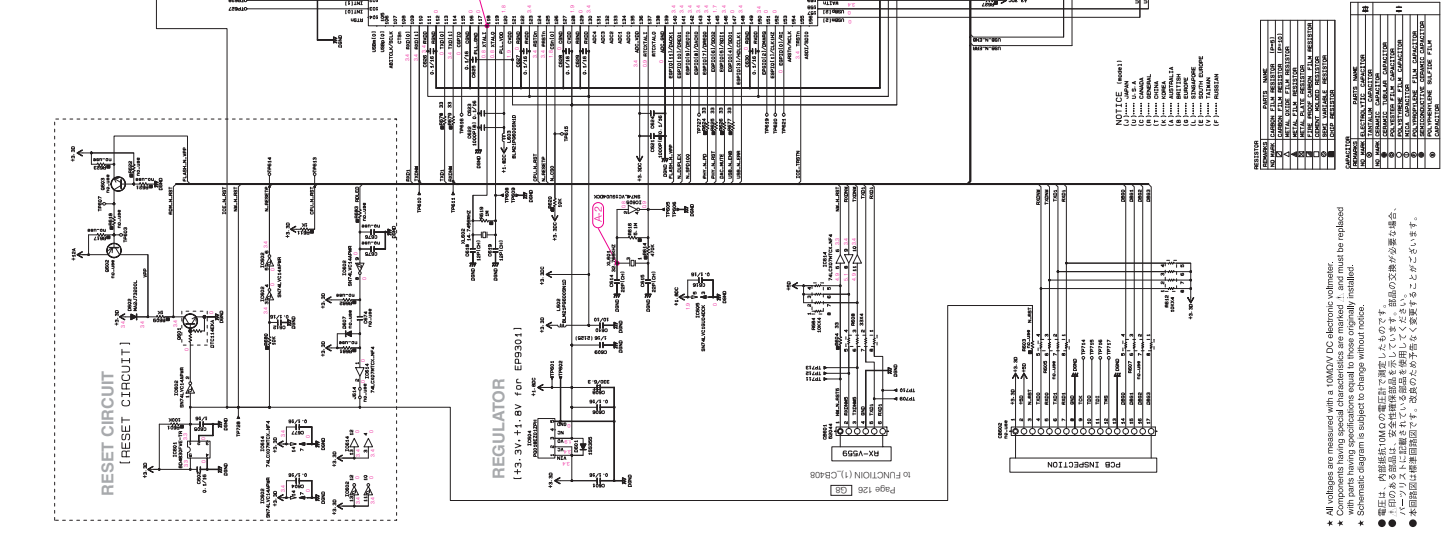

IC609 M2020C3B4
Dual-channel power distribution switch

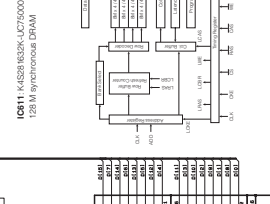

IC611 K4S581632K-LCT5000
128 M synchronous DRAM

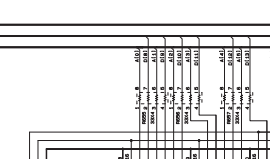

IC612 74L07MTCX
Low voltage hex buffer with open drain outputs

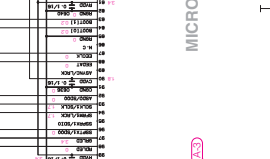

IC613 M2020C3B4-0303
32 Mbit single voltage 3 V only flash memory

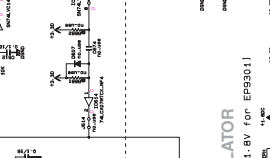

IC614 74L07MTCX
Low voltage hex buffer with open drain outputs



IC615 616 SNT4V03A00R
4-bit synchronous counters



IC616 74L07MTCX
Low voltage hex buffer with open drain outputs



IC617 SNT4V03A00R
4-bit synchronous counters

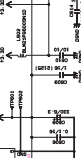

IC618 M2020C3B4-0303
32 Mbit single voltage 3 V only flash memory

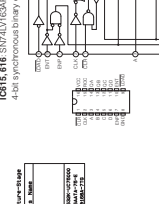

IC619 EP9304-CQZ
System on chip processor

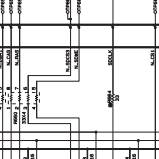

IC620 EP9304-CQZ
System on chip processor



IC621 BO-80PVE-TR
Voltage detector IC

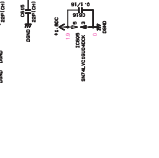

IC622 SNT4V03A00R
4-bit synchronous counters

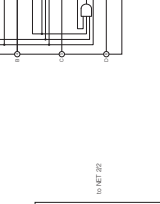

IC623 FQX1REZDZP
Voltage regulator

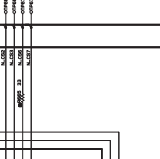

IC624 74L07MTCX
Low voltage hex buffer with open drain outputs

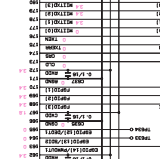

IC625 SNT4V03A00R
4-bit synchronous counters

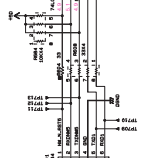

IC626 SNT4V03A00R
4-bit synchronous counters

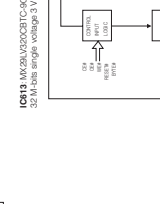

IC627 SNT4V03A00R
4-bit synchronous counters

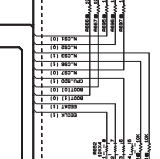

IC628 SNT4V03A00R
4-bit synchronous counters

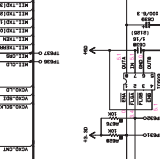

IC629 SNT4V03A00R
4-bit synchronous counters

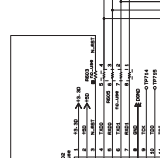

IC630 SNT4V03A00R
4-bit synchronous counters

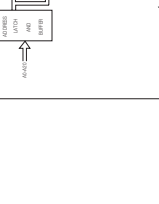

IC631 BO-80PVE-TR
Voltage detector IC



IC632 SNT4V03A00R
4-bit synchronous counters

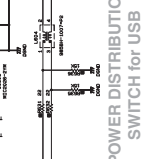

IC633 SNT4V03A00R
4-bit synchronous counters

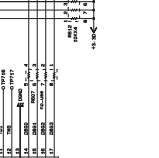

IC634 FQX1REZDZP
Voltage regulator

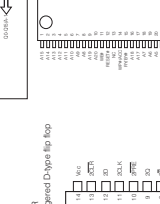

IC635 SNT4V03A00R
4-bit synchronous counters

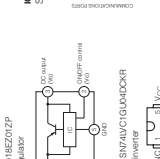

IC636 SNT4V03A00R
4-bit synchronous counters

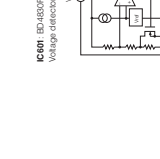

IC637 SNT4V03A00R
4-bit synchronous counters

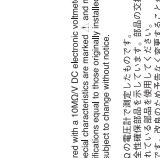

IC638 SNT4V03A00R
4-bit synchronous counters

NOTICE

1. All voltages are measured with a 10MΩV DC electronic voltmeter.
2. Components having special characteristics are marked with an asterisk (*).
3. Schematic diagram is subject to change without notice.
4. The symbol for the component is the same as that of the component in the schematic diagram.
5. The symbol for the component is the same as that of the component in the schematic diagram.
6. The symbol for the component is the same as that of the component in the schematic diagram.
7. The symbol for the component is the same as that of the component in the schematic diagram.
8. The symbol for the component is the same as that of the component in the schematic diagram.
9. The symbol for the component is the same as that of the component in the schematic diagram.
10. The symbol for the component is the same as that of the component in the schematic diagram.

Page 126 of 132
to DSP_C6562
(R.T.K.A.B.G.E.L. Jimohin)

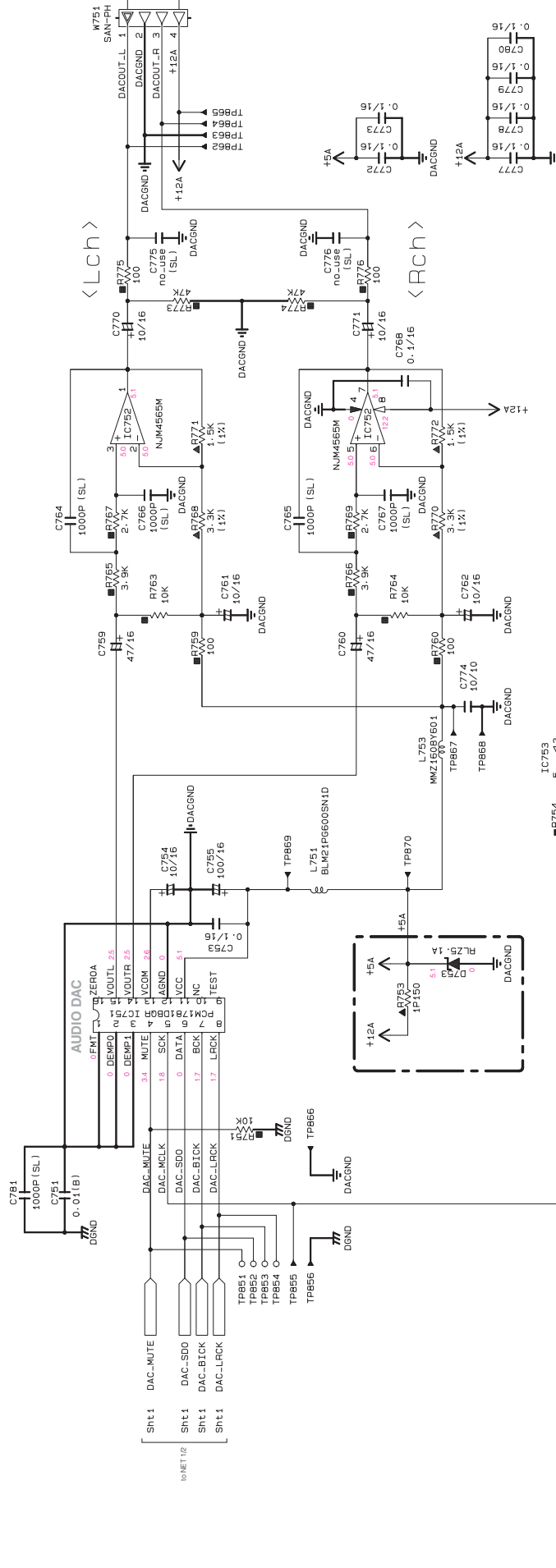

NOTICE (cecas1)

(J)..... JAPAN
 (K)..... KOREA
 (C)..... CANADA
 (R)..... GENERAL
 (T)..... CHINA
 (A)..... AUSTRALIA
 (B)..... BRITISH
 (E)..... EUROPE
 (S)..... SOUTH EUROPE
 (V)..... TAIWAN
 (F)..... RUSSIAN

REMARKS	PARTS NAME	UNIT
①	NO MARK ELECTROLYTIC CAPACITOR	μF
②	TANTALUM CAPACITOR	μF
③	NO MARK CERAMIC CAPACITOR	μF
④	CERAMIC TUBULAR CAPACITOR	μF
⑤	POLYESTER FILM CAPACITOR	μF
⑥	POLYPROPYLENE FILM CAPACITOR	μF
⑦	POLYBUTYLENE FILM CAPACITOR	μF
⑧	SEMICONDUCTIVE CERAMIC CAPACITOR	μF
⑨	NON-POLARIZED ELECTROLYTIC CAPACITOR	μF
⑩	CEMENT MOUNTED RESISTOR	Ω
⑪	CHIP RESISTOR	Ω

REMARKS	PARTS NAME	UNIT
①	NO MARK CERAMIC CAPACITOR	μF
②	CERAMIC TUBULAR CAPACITOR	μF
③	POLYESTER FILM CAPACITOR	μF
④	POLYPROPYLENE FILM CAPACITOR	μF
⑤	POLYBUTYLENE FILM CAPACITOR	μF
⑥	SEMICONDUCTIVE CERAMIC CAPACITOR	μF
⑦	NON-POLARIZED ELECTROLYTIC CAPACITOR	μF
⑧	CEMENT MOUNTED RESISTOR	Ω
⑨	CHIP RESISTOR	Ω

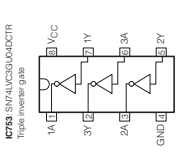
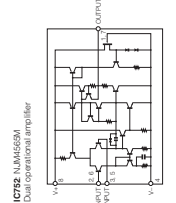
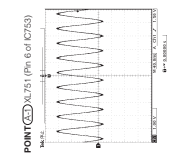
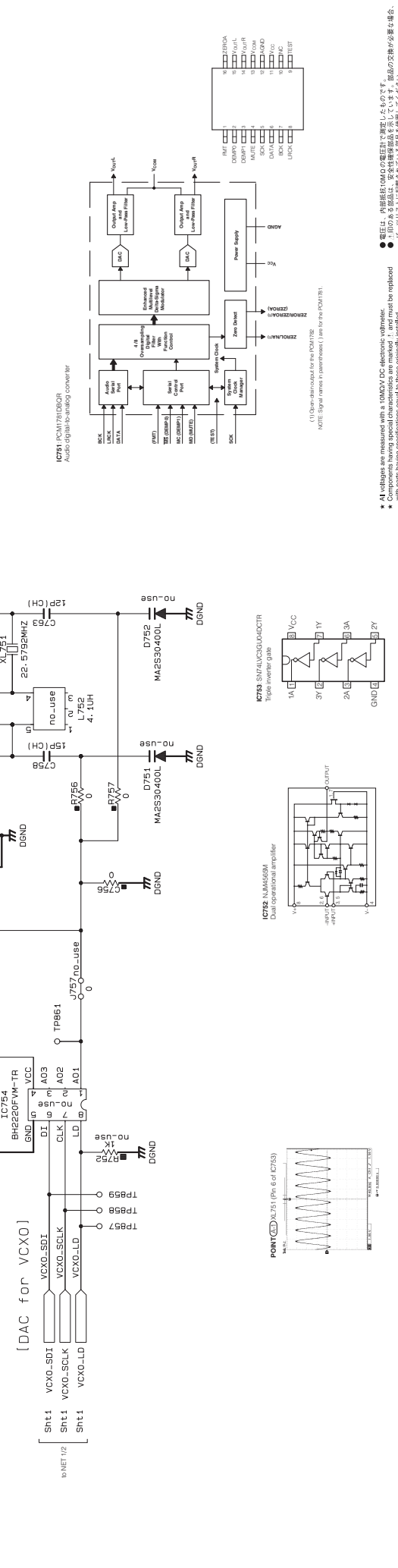

IC751 PCM1791BDCR Audio digital-to-analog converter

(1) Only an abbreviated for the PCM1791B. NOTE: Signal names in parentheses () are for the PCM1791B.

- 電圧は、内部抵抗(10MΩ)の電圧計で測定したものです。
- 1: 目的のある部品は、各特性値が記載されています。部品の交換が必須な場合は、記載の部品名を必ず変更してください。
- 本図面は仕様図面です。改訂のため予告なく変更することがあります。

- All voltages are measured with a 10MΩ DC electronic voltmeter.
- Components having special characteristics are marked 1, and must be replaced with the same components.
- Schematic diagram is subject to change without notice.

CONNECT

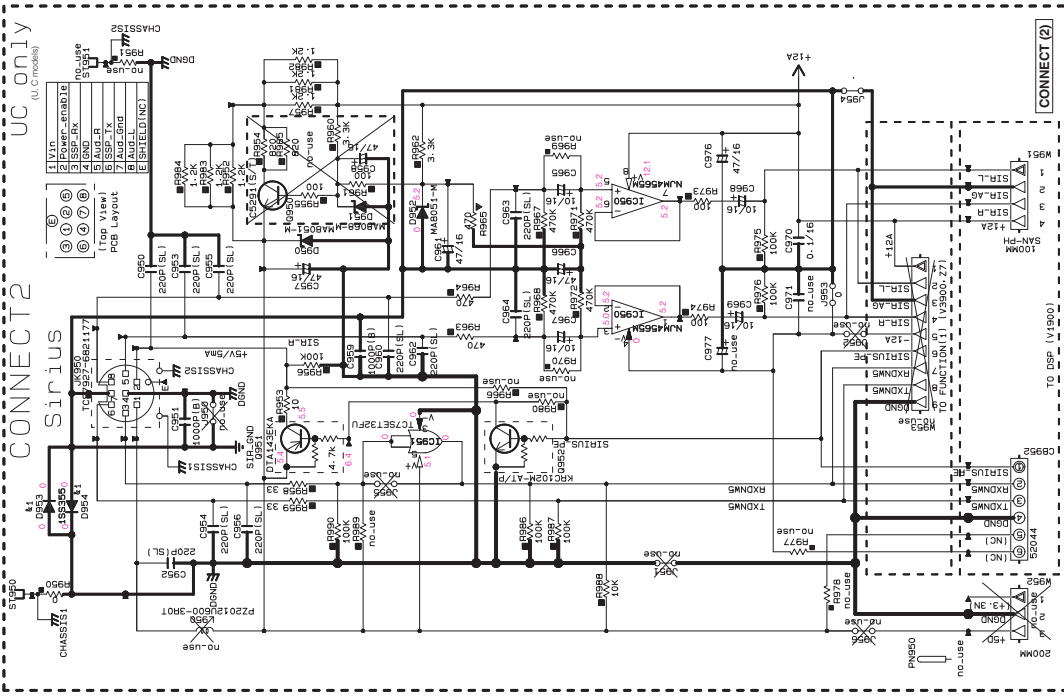
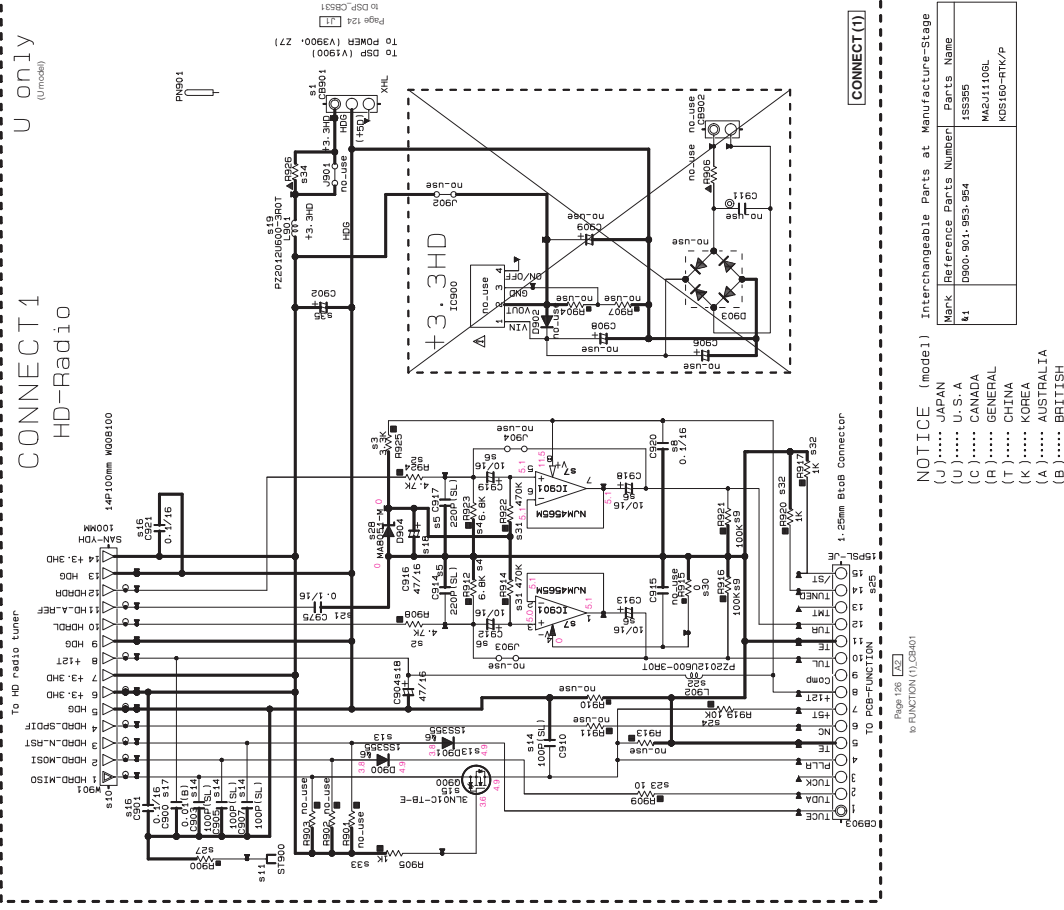

SAX	Destination Part List	C
91	CB901	U
92	RB901	X
93	RB902	X
94	RB903	X
95	RB904	X
96	RB905	X
97	RB906	X
98	RB907	X
99	RB908	X
100	RB909	X
101	RB910	X
102	RB911	X
103	RB912	X
104	RB913	X
105	RB914	X
106	RB915	X
107	RB916	X
108	RB917	X
109	RB918	X
110	RB919	X
111	RB920	X
112	RB921	X
113	RB922	X
114	RB923	X
115	RB924	X
116	RB925	X
117	RB926	X
118	RB927	X
119	RB928	X
120	RB929	X
121	RB930	X
122	RB931	X
123	RB932	X
124	RB933	X
125	RB934	X
126	RB935	X
127	RB936	X
128	RB937	X
129	RB938	X
130	RB939	X
131	RB940	X
132	RB941	X
133	RB942	X
134	RB943	X
135	RB944	X
136	RB945	X
137	RB946	X
138	RB947	X
139	RB948	X
140	RB949	X
141	RB950	X
142	RB951	X
143	RB952	X
144	RB953	X
145	RB954	X
146	RB955	X
147	RB956	X
148	RB957	X
149	RB958	X
150	RB959	X
151	RB960	X
152	RB961	X
153	RB962	X
154	RB963	X
155	RB964	X
156	RB965	X
157	RB966	X
158	RB967	X
159	RB968	X
160	RB969	X
161	RB970	X
162	RB971	X
163	RB972	X
164	RB973	X
165	RB974	X
166	RB975	X
167	RB976	X
168	RB977	X
169	RB978	X
170	RB979	X
171	RB980	X
172	RB981	X
173	RB982	X
174	RB983	X
175	RB984	X
176	RB985	X
177	RB986	X
178	RB987	X
179	RB988	X
180	RB989	X
181	RB990	X
182	RB991	X
183	RB992	X
184	RB993	X
185	RB994	X
186	RB995	X
187	RB996	X
188	RB997	X
189	RB998	X
190	RB999	X

NA No.	WP15590
NC No.	XB907

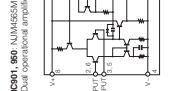
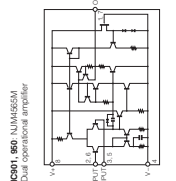
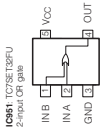

Mark	Reference Parts Number	Parts Name
11	1SS395	DIODE
12	D900-901-993-994	RESISTOR
13	MA241108L	DIODE
14	KDS160-RTK/P	DIODE

Page 126 (3/3)
FUNCTION (1)_CR408
TO DSP_C8462

REMARKS	PARTS NAME
NO MARK	ELECTROLYTIC CAPACITOR
NO MARK	TANTALUM CAPACITOR
NO MARK	CERAMIC TUBULAR CAPACITOR
NO MARK	CERAMIC CAPACITOR
NO MARK	POLYESTER FILM CAPACITOR
NO MARK	POLYSTYRENE FILM CAPACITOR
NO MARK	MICA CAPACITOR
NO MARK	POLYPROPYLENE FILM CAPACITOR
NO MARK	SEMICONDUCTIVE CERAMIC CAPACITOR
NO MARK	POLYPHENYLENE SULFIDE FILM CAPACITOR

REMARKS	PARTS NAME
NO MARK	CARBON FILM RESISTOR (P=5)
NO MARK	CARBON FILM RESISTOR (P=10)
NO MARK	METAL OXIDE FILM RESISTOR
NO MARK	METAL FILM RESISTOR
NO MARK	METAL PLATE RESISTOR
NO MARK	FIRE PROOF CARBON FILM RESISTOR
NO MARK	TEMPERATURE COMPENSATED CARBON FILM RESISTOR
NO MARK	SEMI VARIABLE RESISTOR
NO MARK	CHIP RESISTOR

NOTICE (model1) Interchangeable Parts at Manufacture-Stage
(J)..... JAPAN
(U)..... U.S.A
(C)..... CANADA
(R)..... GENERAL
(T)..... CHINA
(K)..... KOREA
(A)..... AUSTRALIA
(B)..... BRITISH
(G)..... EUROPE
(L)..... SINGAPORE
(E)..... SOUTH
(V)..... TAIWAN
(F)..... RUSSIAN

All voltages are measured with a 100MΩ DC electronic voltmeter.
Components having special characteristics are marked with an asterisk (*).
Schematic diagram is subject to change without notice.
電圧は、100メガΩの電圧計で測定したものです。
特別な特性を有する部品は、*印を付けて表示されています。部品の交換が必要の場合は、*印のある部品は、交換仕様を必ずご確認ください。
本図面は仕様変更が行われる場合がありますので、ご了承ください。

■ REPLACEMENT PARTS LIST

● ELECTRICAL COMPONENT PARTS

WARNING

- Components having special characteristics are marked Δ and must be replaced with parts having specifications equal to those originally installed.
- The chip resistor is not supplied as a replacement part.
 - * When a chip resistor is necessary, use the following part.
AAX60720: CHIP RESISTOR SAMPLE BOOK
- Δ 印のある部分は、安全確保部品を示しています。部品の交換が必要な場合、パーツリストに記載されている部品を使用してください。
- チップ抵抗はサービス部品として供給しません。
 - ※ チップ抵抗が必要な場合は、下記の部品をご利用ください。
AAX60720 : CHIP RESISTOR SAMPLE BOOK
- 部品価格ランクは、予告なく変更することがあります。

ABBREVIATIONS IN THIS LIST ARE AS FOLLOWS:

C.A.EL.CHP	: CHIP ALUMI.ELECTROLYTIC CAP	L.EMIT	: LIGHT EMITTING MODULE
C.CE	: CERAMIC CAP	LED.DSPLY	: LED DISPLAY
C.CE.ARRAY	: CERAMIC CAP ARRAY	LED.INFRD	: LED,INFRARED
C.CE.CHP	: CHIP CERAMIC CAP	MODUL.RF	: MODULATOR,RF
C.CE.ML	: MULTILAYER CERAMIC CAP	PHOT.CPL	: PHOTO COUPLER
C.CE.M.CHP	: CHIP MULTILAYER CERAMIC CAP	PHOT.INTR	: PHOTO INTERRUPTER
C.CE.SAFTY	: RECOGNIZED CERAMIC CAP	PHOT.RFLCT	: PHOTO REFLECTOR
C.CE.TUBLR	: CERAMIC TUBULAR CAP	PIN.TEST	: PIN,TEST POINT
C.CE.SMI	: SEMI CONDUCTIVE CERAMIC CAP	PLST.RIVET	: PLASTIC RIVET
C.EL	: ELECTROLYTIC CAP	R.ARRAY	: RESISTOR ARRAY
C.MICA	: MICA CAP	R.CAR.	: CARBON RESISTOR
C.ML.FLM	: MULTILAYER FILM CAP	R.CAR.CHP	: CHIP RESISTOR
C.MP	: METALLIZED PAPER CAP	R.CAR.FP	: FLAME PROOF CARBON RESISTOR
C.MYLAR	: MYLAR FILM CAP	R.FUS	: FUSABLE RESISTOR
C.MYLAR.ML	: MULTILAYER MYLAR FILM CAP	R.MTL.CHP	: CHIP METAL FILM RESISTOR
C.PAPER	: PAPER CAPACITOR	R.MTL.FLM	: METAL FILM RESISTOR
C.PLS	: POLYSTYRENE FILM CAP	R.MTL.OXD	: METAL OXIDE FILM RESISTOR
C.POL	: POLYESTER FILM CAP	R.MTL.PLAT	: METAL PLATE RESISTOR
C.POLY	: POLYETHYLENE FILM CAP	RSNR.CE	: CERAMIC RESONATOR
C.PP	: POLYPROPYLENE FILM CAP	RSNR.CRYS	: CRYSTAL RESONATOR
C.TNTL	: TANTALUM CAP	R.TW.CEM	: TWIN CEMENT FIXED RESISTOR
C.TNTL.CHP	: CHIP TANTALUM CAP	R.CEMENT	: CEMENT RESISTOR
C.TRIM	: TRIMMER CAP	SCR.BND.HD	: BIND HEAD B-TIGHT SCREW
CN	: CONNECTOR	SCR.BW.HD	: BW HEAD TAPPING SCREW
CN.BS.PIN	: CONNECTOR,BASE PIN	SCR.CUP	: CUP TIGHT SCREW
CN.CANNON	: CONNECTOR,CANNON	SCR.TERM	: SCREW TERMINAL
CN.DIN	: CONNECTOR,DIN	SCR.TR	: SCREW,TRANSISTOR
CN.FLAT	: CONNECTOR,FLAT CABLE	SUPRT.PCB	: SUPPORT,P.C.B.
CN.POST	: CONNECTOR,BASE POST	SURG.PRTCT	: SURGE PROTECTOR
COIL.MX.AM	: COIL,AM MIX	SW.TACT	: TACT SWITCH
COIL.AT.FM	: COIL,FM ANTENNA	SW.LEAF	: LEAF SWITCH
COIL.DT.FM	: COIL,FM DETECT	SW.LEVER	: LEVER SWITCH
COIL.MX.FM	: COIL,FM MIX	SW.MICRO	: MICRO SWITCH
COIL.OUTPT	: OUTPUT COIL	SW.PUSH	: PUSH SWITCH
DIOD.ARRAY	: DIODE ARRAY	SW.RT.ENC	: ROTARY ENCODER
DIODE.BRG	: DIODE BRIDGE	SW.RT.MTR	: ROTARY SWITCH WITH MOTOR
DIODE.CHP	: CHIP DIODE	SW.RT	: ROTARY SWITCH
DIODE.VAR	: VARACTOR DIODE	SW.SLIDE	: SLIDE SWITCH
DIOD.Z.CHP	: CHIP ZENER DIODE	TERM.SP	: SPEAKER TERMINAL
DIODE.ZENR	: ZENER DIODE	TERM.WRAP	: WRAPPING TERMINAL
DSCR.CE	: CERAMIC DISCRIMINATOR	THRMST.CHP	: CHIP THERMISTOR
FER.BEAD	: FERRITE BEADS	TR.CHP	: CHIP TRANSISTOR
FER.CORE	: FERRITE CORE	TR.DGT	: DIGITAL TRANSISTOR
FET.CHP	: CHIP FET	TR.DGT.CHP	: CHIP DIGITAL TRANSISTOR
FL.DSPLY	: FLUORESCENT DISPLAY	TRANS	: TRANSFORMER
FLTR.CE	: CERAMIC FILTER	TRANS.PULS	: PULSE TRANSFORMER
FLTR.COMB	: COMB FILTER MODULE	TRANS.PWR	: POWER TRANSFORMER ASS'Y
FLTR.LC.RF	: LC FILTER,EMI	TUNER.AM	: TUNER PACK,AM
GND.MTL	: GROUND PLATE	TUNER.FM	: TUNER PACK,FM
GND.TERM	: GROUND TERMINAL	TUNER.PK	: FRONT-ENDTUNER PACK
HOLDER.FUS	: FUSE HOLDER	VR	: ROTARY POTENTIOMETER
IC.PRTCT	: IC PROTECTOR	VR.MTR	: POTENTIOMETER WITH MOTOR
JUMPER.CN	: JUMPER CONNECTOR	VR.SW	: POTENTIOMETER WITH ROTARY SW
JUMPER.TST	: JUMPER,TEST POINT	VR.SLIDE	: SLIDE POTENTIOMETER
L.DTCT	: LIGHT DETECTING MODULE	VR.TRIM	: TRIMMER POTENTIOMETER

P.C.B. DSP

Ref No.	Part No.	Description	Remarks	Markets	部 品 名	ランク	
*	WK647900	P. C. B.	DSP		JRTKABGEL	P C B D S P	
*	WK648000	P. C. B.	DSP		UC	P C B D S P	
*	CB502	WJ458700	CN. XM	4P CAM-D96		UC	X Mコネクタ
	CB503	V9356900	CN. JE	19P SE			J Eコネクタプラグ
	CB504	VQ047100	CN. BS. PIN	7P			F F Cコネクタ
	CB505	VU443800	CN. JE	15P SE			J Eコネクタプラグ
	CB530	V8809800	CN. JE	9P SE			J Eコネクタプラグ
	CB531	LB919030	CN. BS. PIN	3P			ベース付ポスト
	CB536	V8875300	CN. JE	13P SE			J Eコネクタプラグ
	CB560	LB918020	CN. BS. PIN	2P			ベース付ポスト
	CB561	VQ048000	CN. BS. PIN	31P			F F Cコネクタ
	CB562	VB858300	CN. BS. PIN	4P			コネクタベースポスト
	C5001-5003	US061220	C. CE. CHP	22pF 50V B			チップセラコン
	C5004-5009	US135100	C. CE. CHP	0. 1uF 16V			チップセラコン
	C5010-5011	US135100	C. CE. CHP	0. 1uF 16V		UC	チップセラコン
	C5012-5014	US135100	C. CE. CHP	0. 1uF 16V			チップセラコン
	C5015-5017	UR237220	C. EL	22uF 16V			ケミコン
	C5019	US063100	C. CE. CHP	1000pF 50V B		UC	チップセラコン
	C5022	US135100	C. CE. CHP	0. 1uF 16V		UC	チップセラコン
	C5024	US135100	C. CE. CHP	0. 1uF 16V		UC	チップセラコン
	C5025	UR067470	C. EL	47uF 50V			ケミコン
	C5028	US135100	C. CE. CHP	0. 1uF 16V			チップセラコン
	C5031	US135100	C. CE. CHP	0. 1uF 16V			チップセラコン
	C5032	US062220	C. CE. CHP	220pF 50V B			チップセラコン
	C5033	UR267100	C. EL	10uF 50V			ケミコン
	C5034	US062220	C. CE. CHP	220pF 50V B			チップセラコン
	C5035	US135100	C. CE. CHP	0. 1uF 16V		UC	チップセラコン
	C5036	UR067470	C. EL	47uF 50V			ケミコン
	C5037	US135100	C. CE. CHP	0. 1uF 16V			チップセラコン
	C5038	US062220	C. CE. CHP	220pF 50V B			チップセラコン
	C5039	US135100	C. CE. CHP	0. 1uF 16V			チップセラコン
	C5040	US062220	C. CE. CHP	220pF 50V B			チップセラコン
	C5041-5043	US135100	C. CE. CHP	0. 1uF 16V		UC	チップセラコン
	C5044	UR837470	C. EL	47uF 16V		UC	ケミコン
	C5045	US135100	C. CE. CHP	0. 1uF 16V		UC	チップセラコン
	C5046	UR238100	C. EL	100uF 16V			ケミコン
	C5047	US061100	C. CE. CHP	10pF 50V B		UC	チップセラコン
	C5048-5049	US135100	C. CE. CHP	0. 1uF 16V			チップセラコン
	C5050	VE326000	C. MYLAR	0. 1uF 50V			マイラーコン
	C5051	VE326600	C. MYLAR	0. 33uF 50V			マイラーコン
	C5052	WJ605400	C. MYLAR	0. 022uF 50V J			マイラーコン
	C5053-5055	US135100	C. CE. CHP	0. 1uF 16V			チップセラコン
	C5056	US061100	C. CE. CHP	10pF 50V B		UC	チップセラコン
	C5057-5058	UR267100	C. EL	10uF 50V			ケミコン
	C5059	US062100	C. CE. CHP	100pF 50V B			チップセラコン
	C5060	UR067470	C. EL	47uF 50V			ケミコン
	C5061	US061470	C. CE. CHP	47pF 50V B			チップセラコン
	C5062	UR067470	C. EL	47uF 50V			ケミコン
	C5063-5066	US135100	C. CE. CHP	0. 1uF 16V			チップセラコン
	C5067	UR067470	C. EL	47uF 50V			ケミコン
	C5068-5069	US135100	C. CE. CHP	0. 1uF 16V			チップセラコン
	C5070	US062100	C. CE. CHP	100pF 50V B			チップセラコン
	C5071	US135100	C. CE. CHP	0. 1uF 16V			チップセラコン
	C5072-5073	US062100	C. CE. CHP	100pF 50V B			チップセラコン
	C5074-5075	US062220	C. CE. CHP	220pF 50V B			チップセラコン

* New Parts * 新規部品

P.C.B. DSP

Ref No.	Part No.	Description	Remarks	Markets	部 品 名	ランク	
C5076	US135100	C. CE. CHP	0. 1uF	16V		チップセラコン	01
C5077	US062100	C. CE. CHP	100pF	50V B		チップセラコン	01
* C5078-5079	WP172700	C. MYLAR	390pF	50V		マイラーコン	
C5080-5081	UR267100	C. EL	10uF	50V		ケミコン	
C5082-5083	US135100	C. CE. CHP	0. 1uF	16V		チップセラコン	01
C5084-5086	UR067100	C. EL	10uF	50V		ケミコン	01
C5087	US135100	C. CE. CHP	0. 1uF	16V		チップセラコン	01
C5088-5091	US061100	C. CE. CHP	10pF	50V B		チップセラコン	01
C5301	US062100	C. CE. CHP	100pF	50V B		チップセラコン	01
C5302	UR067470	C. EL	47uF	50V		ケミコン	01
C5303	UR238100	C. EL	100uF	16V		ケミコン	
C5304	UR267100	C. EL	10uF	50V		ケミコン	
C5305	US126100	C. CE. CHP	1uF	10V		チップセラコン	01
C5307-5313	US135100	C. CE. CHP	0. 1uF	16V		チップセラコン	01
C5314	UR067100	C. EL	10uF	50V		ケミコン	01
C5315-5322	US135100	C. CE. CHP	0. 1uF	16V		チップセラコン	01
C5323-5334	US061470	C. CE. CHP	47pF	50V B		チップセラコン	01
C5336	US135100	C. CE. CHP	0. 1uF	16V		チップセラコン	01
C5338	US135100	C. CE. CHP	0. 1uF	16V		チップセラコン	01
C5341-5343	US135100	C. CE. CHP	0. 1uF	16V		チップセラコン	01
C5344	UR067100	C. EL	10uF	50V		ケミコン	01
C5345-5346	US135100	C. CE. CHP	0. 1uF	16V		チップセラコン	01
C5348-5350	US135100	C. CE. CHP	0. 1uF	16V		チップセラコン	01
C5355-5362	US135100	C. CE. CHP	0. 1uF	16V		チップセラコン	01
C5363	UR067470	C. EL	47uF	50V		ケミコン	01
C5364-5367	US135100	C. CE. CHP	0. 1uF	16V		チップセラコン	01
C5368-5370	US063100	C. CE. CHP	1000pF	50V B		チップセラコン	01
C5371-5372	US135100	C. CE. CHP	0. 1uF	16V		チップセラコン	01
C5373-5375	US063100	C. CE. CHP	1000pF	50V B		チップセラコン	01
C5376-5377	US135100	C. CE. CHP	0. 1uF	16V		チップセラコン	01
C5378	UR238100	C. EL	100uF	16V		ケミコン	
C5379	WG251600	C. CE. CHP	4. 7uF	6. 3V		チップセラコン	01
C5380-5381	UR238100	C. EL	100uF	16V		ケミコン	
C5382	US135100	C. CE. CHP	0. 1uF	16V		チップセラコン	01
C5383-5384	WG251600	C. CE. CHP	4. 7uF	6. 3V		チップセラコン	01
C5385	UR239100	C. EL	1000uF	16V		ケミコン	
C5386-5387	US135100	C. CE. CHP	0. 1uF	16V		チップセラコン	01
C5388	UR238100	C. EL	100uF	16V		ケミコン	
C5389	WG251600	C. CE. CHP	4. 7uF	6. 3V		チップセラコン	01
C5390	US135100	C. CE. CHP	0. 1uF	16V		チップセラコン	01
C5391	WG251600	C. CE. CHP	4. 7uF	6. 3V		チップセラコン	01
C5392-5393	UR239100	C. EL	1000uF	16V		ケミコン	
C5394	US135330	C. CE. CHP	0. 33uF	16V		チップセラコン	01
C5395	UR239100	C. EL	1000uF	16V		ケミコン	
C5396-5397	US135100	C. CE. CHP	0. 1uF	16V		チップセラコン	01
C5398	UR238100	C. EL	100uF	16V	UC	ケミコン	
C5399-5400	US135100	C. CE. CHP	0. 1uF	16V	UC	チップセラコン	01
C5401	UR238100	C. EL	100uF	16V	UC	ケミコン	
C5402	US135100	C. CE. CHP	0. 1uF	16V	UC	チップセラコン	01
C5403	UR218470	C. EL	470uF	6. 3V	UC	ケミコン	
C5404-5429	US135100	C. CE. CHP	0. 1uF	16V		チップセラコン	01
C5430-5432	US063100	C. CE. CHP	1000pF	50V B		チップセラコン	01
C5433-5442	US135100	C. CE. CHP	0. 1uF	16V		チップセラコン	01
C5443	UR067100	C. EL	10uF	50V		ケミコン	01
C5444	US135100	C. CE. CHP	0. 1uF	16V		チップセラコン	01

* New Parts * 新規部品

P.C.B. DSP

Ref No.	Part No.	Description	Remarks	Markets	部 品 名	ランク	
C5601	US163100	C. CE. CHP	1000pF 50V			チップセラコン	01
C5602-5605	US135100	C. CE. CHP	0. 1uF 16V			チップセラコン	01
C5607-5608	US135100	C. CE. CHP	0. 1uF 16V			チップセラコン	01
C5609	UR067100	C. EL	10uF 50V			ケミコン	01
C5610	US135100	C. CE. CHP	0. 1uF 16V			チップセラコン	01
C5611	UR067100	C. EL	10uF 50V			ケミコン	01
C5612	US135100	C. CE. CHP	0. 1uF 16V			チップセラコン	01
C5613	US062100	C. CE. CHP	100pF 50V B			チップセラコン	01
C5614-5615	UR348100	C. EL	100uF 25V			ケミコン	01
C5616	UR067100	C. EL	10uF 50V			ケミコン	01
C5617	US126100	C. CE. CHP	1uF 10V			チップセラコン	01
C5618-5623	US135100	C. CE. CHP	0. 1uF 16V			チップセラコン	01
C5624	UR067100	C. EL	10uF 50V			ケミコン	01
C5625	US135100	C. CE. CHP	0. 1uF 16V			チップセラコン	01
C5626	UR067100	C. EL	10uF 50V			ケミコン	01
C5627-5629	US135100	C. CE. CHP	0. 1uF 16V			チップセラコン	01
C5630-5633	WJ602900	C. MYLAR	100pF 50V K			マイラーコン	01
C5634-5635	US135100	C. CE. CHP	0. 1uF 16V			チップセラコン	01
C5636-5637	WJ605400	C. MYLAR	0. 022uF 50V J			マイラーコン	01
C5638-5639	US135100	C. CE. CHP	0. 1uF 16V			チップセラコン	01
C5640-5643	WJ603300	C. MYLAR	470pF 50V J			マイラーコン	01
C5644-5646	US135100	C. CE. CHP	0. 1uF 16V			チップセラコン	01
C5647-5649	UU267100	C. EL	10uF 50V			ケミコン FW	01
C5650-5652	US135100	C. CE. CHP	0. 1uF 16V			チップセラコン	01
C5653	UU267100	C. EL	10uF 50V			ケミコン FW	01
C5654-5656	US135100	C. CE. CHP	0. 1uF 16V			チップセラコン	01
C5657-5658	UU267220	C. EL	22uF 50V			ケミコン FW	01
C5659-5660	US135100	C. CE. CHP	0. 1uF 16V			チップセラコン	01
C5661-5662	UR067470	C. EL	47uF 50V			ケミコン	01
C5663-5665	US135100	C. CE. CHP	0. 1uF 16V			チップセラコン	01
C5666-5667	US064100	C. CE. CHP	0. 01uF 50V B		UC	チップセラコン	01
C5668-5672	US135100	C. CE. CHP	0. 1uF 16V			チップセラコン	01
C5673	UR237470	C. EL	47uF 16V		UC	ケミコン	01
C5674	UR237100	C. EL	10uF 16V		UC	ケミコン	01
C5675	US135100	C. CE. CHP	0. 1uF 16V		UC	チップセラコン	01
C5676	US135100	C. CE. CHP	0. 1uF 16V			チップセラコン	01
C5677-5678	UR237470	C. EL	47uF 16V		UC	ケミコン	01
C5679	US135100	C. CE. CHP	0. 1uF 16V			チップセラコン	01
C5680-5681	WJ604200	C. MYLAR	2700pF 50V		UC	マイラーコン	01
C5682-5683	US135100	C. CE. CHP	0. 1uF 16V			チップセラコン	01
C5684-5685	WJ604200	C. MYLAR	2700pF 50V		UC	マイラーコン	01
C5686	US135100	C. CE. CHP	0. 1uF 16V			チップセラコン	01
C5687-5688	UR237100	C. EL	10uF 16V		UC	ケミコン	01
C5689	US063100	C. CE. CHP	1000pF 50V B			チップセラコン	01
C5690-5697	US135100	C. CE. CHP	0. 1uF 16V			チップセラコン	01
C5698-5699	US135100	C. CE. CHP	0. 1uF 16V		UC	チップセラコン	01
C5700-5701	UR237470	C. EL	47uF 16V		UC	ケミコン	01
C5704-5705	US135100	C. CE. CHP	0. 1uF 16V			チップセラコン	01
C5708	US135100	C. CE. CHP	0. 1uF 16V			チップセラコン	01
C5709	UR067470	C. EL	47uF 50V			ケミコン	01
C5710	US135100	C. CE. CHP	0. 1uF 16V			チップセラコン	01
C5712-5714	US163100	C. CE. CHP	1000pF 50V			チップセラコン	01
C5715	US135100	C. CE. CHP	0. 1uF 16V			チップセラコン	01
C5716-5717	US163100	C. CE. CHP	1000pF 50V			チップセラコン	01
C5718-5720	UR067470	C. EL	47uF 50V			ケミコン	01

* New Parts * 新規部品

P.C.B. DSP

Ref No.	Part No.	Description	Remarks	Markets	部 品 名	ランク
C5721	US135100	C. CE. CHP	0. 1uF 16V		チップセラコン	01
C5722-5723	UR067470	C. EL	47uF 50V		ケミコン	01
C5724-5726	US135100	C. CE. CHP	0. 1uF 16V		チップセラコン	01
C5728-5729	US135100	C. CE. CHP	0. 1uF 16V		チップセラコン	01
C5730	UR348100	C. EL	100uF 25V		ケミコン	01
C5731	UR067470	C. EL	47uF 50V		ケミコン	01
C5732	UR348100	C. EL	100uF 25V		ケミコン	01
C5734-5735	UR067470	C. EL	47uF 50V		ケミコン	01
C5736-5738	US135100	C. CE. CHP	0. 1uF 16V		チップセラコン	01
C5740-5744	US135100	C. CE. CHP	0. 1uF 16V		チップセラコン	01
C5746-5747	US135100	C. CE. CHP	0. 1uF 16V		チップセラコン	01
C5748-5750	UR067100	C. EL	10uF 50V		ケミコン	01
C5752-5753	UR067100	C. EL	10uF 50V		ケミコン	01
* C5754-5758	WJ603400	C. MYLAR	560pF 50V		マイラーコン	
* C5759-5763	WJ604700	C. MYLAR	6800pF 50V		マイラーコン	
* C5765	WJ605900	C. MYLAR	0. 056uF 50V		マイラーコン	
* C5766-5769	WJ604700	C. MYLAR	6800pF 50V		マイラーコン	
* C5770-5774	WP172700	C. MYLAR	390pF 50V		マイラーコン	
C5775	UR067470	C. EL	47uF 50V		ケミコン	01
* C5776	WJ605200	C. MYLAR	0. 015uF 50V		マイラーコン	
* C5777-5785	WP172700	C. MYLAR	390pF 50V		マイラーコン	
C5786	US135100	C. CE. CHP	0. 1uF 16V		チップセラコン	01
* C5787	WJ605200	C. MYLAR	0. 015uF 50V		マイラーコン	
* C5788-5791	WP172700	C. MYLAR	390pF 50V		マイラーコン	
C5797	US135100	C. CE. CHP	0. 1uF 16V		チップセラコン	01
C5803-5807	WK041800	C. EL	10uF 16V		ケミコン	01
C5808	US135100	C. CE. CHP	0. 1uF 16V		チップセラコン	01
C5809	UR267100	C. EL	10uF 50V		ケミコン	
C5810-5813	WK041800	C. EL	10uF 16V		ケミコン	01
C5814-5825	US135100	C. CE. CHP	0. 1uF 16V		チップセラコン	01
C5826-5827	UR267470	C. EL	47uF 50V		ケミコン	01
C5828-5829	UR067470	C. EL	47uF 50V		ケミコン	01
C5830-5831	UR267470	C. EL	47uF 50V		ケミコン	01
C5834-5842	US135100	C. CE. CHP	0. 1uF 16V		チップセラコン	01
C5844-5851	US135100	C. CE. CHP	0. 1uF 16V		チップセラコン	01
C5852-5854	US063100	C. CE. CHP	1000pF 50V B		チップセラコン	01
C5855-5856	US135100	C. CE. CHP	0. 1uF 16V		チップセラコン	01
C5857-5859	US063100	C. CE. CHP	1000pF 50V B		チップセラコン	01
C5860-5861	US135100	C. CE. CHP	0. 1uF 16V		チップセラコン	01
C5900	US035100	C. CE. CHP	0. 1uF 16V B		チップセラコン	01
C5920-5922	US035100	C. CE. CHP	0. 1uF 16V B		チップセラコン	01
C5930-5931	US035100	C. CE. CHP	0. 1uF 16V B		チップセラコン	01
C5940-5945	US035100	C. CE. CHP	0. 1uF 16V B		チップセラコン	01
* C5946-5947	WJ603400	C. MYLAR	560pF 50V		マイラーコン	
D5001-5003	WE674800	DIODE	AVRL161A1R1NTB	UC	チップバリスタ	01
D5301-5303	VT332900	DIODE	1SS355		ダイオード	01
D5305	VT332900	DIODE	1SS355		ダイオード	01
D5306	VT332900	DIODE	1SS355	UC	ダイオード	01
D5308	VT332900	DIODE	1SS355		ダイオード	01
D5309	VT332900	DIODE	1SS355	UC	ダイオード	01
D5310-5311	VT332900	DIODE	1SS355		ダイオード	01
D5600-5609	VV220700	DIODE. SHOT	RB501V-40		ショットキーダイオード	01
IC501	X3936A00	IC	SN74LVU04APWR		ロジック I C	
IC502	X3018A00	IC	SN74AHCT00PWR NAND		ロジック I C	01
IC503	X8192A00	IC	F2621E-01-TR	UC	I C	

* New Parts * 新規部品

P.C.B. DSP

Ref No.	Part No.	Description	Remarks	Markets	部 品 名	ランク
IC504-505	XN518A00	IC	SN74LS151NSR 8-1 S		ロジック I C	04
IC506	X7746A00	IC	LC89057W-VF4AD-E		I C	07
IC507-508	XV894A00	IC	TC74VHC153FT MULTI		ロジック I C	03
IC509	X6123A00	IC	SN74LV157APWR		ロジック I C	02
IC510	X3505A00	IC	NJM2068MD-TE2		アンプ I C	02
IC511	XY074B00	IC	TC74VHC125FT (EL, K)		ロジック I C	01
IC512	XR680A00	IC	TC7SH08FU (TE85L, JF)		ロジック I C	01
IC531	XR680A00	IC	TC7SH08FU (TE85L, JF)		ロジック I C	01
IC532-533	XW814A00	IC	TC7SET32FU		ロジック I C	01
IC535	X3824A00	IC	SN74AHC08PWR		ロジック I C	01
IC536	X3693A00	IC	SN74LV245APWR TRAN		ロジック I C	
IC537	XR680A00	IC	TC7SH08FU (TE85L, JF)		ロジック I C	01
IC538	XW814A00	IC	TC7SET32FU		ロジック I C	01
IC539	XR680A00	IC	TC7SH08FU (TE85L, JF)		ロジック I C	01
* IC540	YA019A00	I.C. MEMORY	S29AL016D70TF I020	written	メモリ I C 1 6 M	
IC541-542	X7195A00	IC	R1172S121D-E2-F		電源 I C	04
IC543	X7964A00	IC	PQ200WNA1ZPH		電源 I C	03
IC544	X6869A00	IC	NJM2885DL1-33		電源 I C	03
IC545	X7964A00	IC	PQ200WNA1ZPH		電源 I C	03
IC546	XR680A00	IC	TC7SH08FU (TE85L, JF)		ロジック I C	01
IC560	X6872A00	IC	PCM1804DBR		A/Dコンバーター	07
IC561-563	X3505A00	IC	NJM2068MD-TE2		アンプ I C	02
IC564	X6231A00	IC	AK4384ET		I C	
IC565	X5482A00	IC	NE5532DR OP AMP		アンプ I C	01
IC566	X6123A00	IC	SN74LV157APWR		ロジック I C	02
IC569-571	X7947A00	IC	DSD1791DBR		D/Aコンバーター	07
IC573-574	X7947A00	IC	DSD1791DBR		D/Aコンバーター	07
IC575-577	X5482A00	IC	NE5532DR OP AMP		アンプ I C	01
IC579-580	X3505A00	IC	NJM2068MD-TE2		アンプ I C	02
IC581	XR680A00	IC	TC7SH08FU (TE85L, JF)		ロジック I C	01
IC582	X7285A00	IC	TC7SH00FU (TE85L, F)		ロジック I C	01
IC583	XR680A00	IC	TC7SH08FU (TE85L, JF)		ロジック I C	01
IC585	XZ414D00	IC	W9864G6GH-7 SDRAM		メモリ I C 6 4 M	05
IC587	XZ414D00	IC	W9864G6GH-7 SDRAM		メモリ I C 6 4 M	05
IC588	X6123A00	IC	SN74LV157APWR		ロジック I C	02
PJ501	WB491400	JACK. PIN	3P MSD-253V-29 NI		ピンジャック	03
PN530	V9637500	PIN	L=70 #18		スタイルピン	
PN561	V9637500	PIN	L=70 #18		スタイルピン	
Q5001	VV655400	TR. DGT	DTC114EKA		デジタルトランジスタ	01
Q5002	VD303700	TR	2SC3326 A, B		トランジスタ	01
Q5301	VV556500	TR	2SA1037K Q, R, S		トランジスタ	01
R5010	HV753100	R. CAR. FP	1 Ω 1/4W		不燃化カーボン抵抗	01
R5035	HV753100	R. CAR. FP	1 Ω 1/4W		不燃化カーボン抵抗	01
R5070	HV753100	R. CAR. FP	1 Ω 1/4W		不燃化カーボン抵抗	01
R5379	V8070000	R. MTL. FLM	1 Ω 1W		金属被膜抵抗	01
R5381-5385	V8070000	R. MTL. FLM	1 Ω 1W		金属被膜抵抗	01
R5388-5389	V8070000	R. MTL. FLM	1 Ω 1W		金属被膜抵抗	01
R5410	V8070000	R. MTL. FLM	1 Ω 1W		金属被膜抵抗	01
R5655-5656	WQ072300	R. MTL. OXD	2. 2 Ω 1W		酸化金属被膜抵抗	
R5673	HV753100	R. CAR. FP	1 Ω 1/4W		不燃化カーボン抵抗	01
R5708-5709	HV753100	R. CAR. FP	1 Ω 1/4W		不燃化カーボン抵抗	01
R5727-5729	HV753470	R. CAR. FP	4. 7 Ω 1/4W		不燃化カーボン抵抗	01
R5731-5732	HV753470	R. CAR. FP	4. 7 Ω 1/4W		不燃化カーボン抵抗	01
R5780-5781	V8070000	R. MTL. FLM	1 Ω 1W		金属被膜抵抗	01
R5783-5785	V8070000	R. MTL. FLM	1 Ω 1W		金属被膜抵抗	01

* New Parts * 新規部品

RX-V1900/DSP-AX1900

P.C.B. DSP and P.C.B. FUNCTION

Ref No.	Part No.	Description		Remarks	Markets	部 品 名	ランク
ST530	V4040500	SCR. TERM	M3			スクリュー／ターミナル	01
U5001-5002	WH536900	CN. PHOTO. T	1P GP1FAV51TK0F			光ファイバー送信器	04
U5003-5006	WH169900	CN. PHOTO. R	1P GP1FAV51RK0F			光ファイバー受信器	04
XL501	WH455300	RSNR. CRYST	45. 1584MHz		UC	水晶振動子	
XL502	V6931900	RESONATOR	24. 576MHz DS0751SV			水晶発振器	05
	WP408900	P. C. B.	FUNCTION	1900	J	PCB FUNCTION	
	WP409000	P. C. B.	FUNCTION	1900	U	PCB FUNCTION	
	WP409100	P. C. B.	FUNCTION	1900	C	PCB FUNCTION	
	WP409200	P. C. B.	FUNCTION	1900	R	PCB FUNCTION	
	WP409300	P. C. B.	FUNCTION	1900	T	PCB FUNCTION	
	WP409400	P. C. B.	FUNCTION	1900	K	PCB FUNCTION	
	WP409500	P. C. B.	FUNCTION	1900	A	PCB FUNCTION	
	WP409600	P. C. B.	FUNCTION	1900	BGE	PCB FUNCTION	
	WP409700	P. C. B.	FUNCTION	1900	L	PCB FUNCTION	
CB300	VQ048000	CN. BS. PIN	31P	1900		FFCコネクタ	02
CB301	V8809800	CN. JE	9P SE	1900		JEコネクタプラグ	01
CB302	V8875300	CN. JE	13P SE	1900		JEコネクタプラグ	01
CB303	VC166500	CN. BS. PIN	12P	1900		コネクタベースポスト	01
CB350	V8809800	CN. JE	9P SE	1900		JEコネクタプラグ	01
CB351	V7827000	CN	20P TE TUC SERIES	1900		コネクタプラグ	01
CB401	VM859600	CN. BS. PIN	15P	1900	JCRTKABGEL	FFCコネクタ	01
CB401	VU446000	CN. BS. PIN	15P TE	1900	U	JE コネクタ	02
CB402-403	V8875300	CN. JE	13P SE	1900		JEコネクタプラグ	01
CB404	V8809800	CN. JE	9P SE	1900		JEコネクタプラグ	01
CB405	VB389600	CN. BS. PIN	11P	1900		コネクタベースポスト	01
CB406	VB858700	CN. BS. PIN	8P	1900		ベースピン	01
CB407	VB858800	CN. BS. PIN	9P	1900		ベースピン	01
CB408	VQ044200	CN. BS. PIN	6P	1900		FFCコネクタ	01
CB409	VF982200	CN. BS. PIN	14P	1900		コネクタ	02
CB410	VM859500	CN. BS. PIN	11P	1900		FFCコネクタ	01
CB411	VQ044300	CN. BS. PIN	7P	1900		FFCコネクタ	01
CB412-414	V9356900	CN. JE	19P SE	1900		JEコネクタプラグ	
CB416	V8809800	CN. JE	9P SE	1900		JEコネクタプラグ	01
CB453	V7828700	SOCKET	20P SE TUC SERIES	1900		コネクタソケット	01
C3000-3001	UR237100	C. EL	10uF 16V	1900		ケミコン	
C3002	US135220	C. CE. CHP	0. 22uF 16V	1900		チップセラコン	01
C3003-3004	US135100	C. CE. CHP	0. 1uF 16V	1900		チップセラコン	01
C3005-3006	UR267470	C. EL	47uF 50V	1900		ケミコン	01
C3007-3008	UR267100	C. EL	10uF 50V	1900		ケミコン	
C3009	US135100	C. CE. CHP	0. 1uF 16V	1900		チップセラコン	01
C3010-3011	UR267100	C. EL	10uF 50V	1900		ケミコン	
C3013-3016	UR267100	C. EL	10uF 50V	1900		ケミコン	
C3017-3018	UR238100	C. EL	100uF 16V	1900		ケミコン	
C3020-3023	UR238100	C. EL	100uF 16V	1900		ケミコン	
C3024-3025	US062100	C. CE. CHP	100pF 50V B	1900		チップセラコン	01
C3026-3027	WP420700	C. PP	100pF 100V	1900		PPコン	
C3029	US135100	C. CE. CHP	0. 1uF 16V	1900		チップセラコン	01
C3030-3033	US062100	C. CE. CHP	100pF 50V B	1900		チップセラコン	01
C3035	UR266470	C. EL	4. 7uF 50V	1900		ケミコン	
C3036-3037	UR267470	C. EL	47uF 50V	1900		ケミコン	01
C3038-3039	UR266470	C. EL	4. 7uF 50V	1900		ケミコン	
C3040	UR237100	C. EL	10uF 16V	1900		ケミコン	

* New Parts * 新規部品

RX-V1900/DSP-AX1900

P.C.B. FUNCTION

Ref No.	Part No.	Description	Remarks	Markets	部 品 名	ランク
C3041-3042	UR266470	C. EL 4. 7uF 50V	1900		ケミコン	
C3043-3044	UR266330	C. EL 3. 3uF 50V	1900		ケミコン	
C3045-3050	US135100	C. CE. CHP 0. 1uF 16V	1900		チップセラコン	01
C3051	UR267470	C. EL 47uF 50V	1900		ケミコン	01
C3052	US135100	C. CE. CHP 0. 1uF 16V	1900		チップセラコン	01
C3053	UR247330	C. EL 33uF 25V	1900		ケミコン	01
C3054	UR267470	C. EL 47uF 50V	1900		ケミコン	01
C3055	UR267100	C. EL 10uF 50V	1900		ケミコン	
C3056	UR247330	C. EL 33uF 25V	1900		ケミコン	01
C3057	UR267470	C. EL 47uF 50V	1900		ケミコン	01
C3058	UR247330	C. EL 33uF 25V	1900		ケミコン	01
C3059	UR237100	C. EL 10uF 16V	1900		ケミコン	
C3060	UR247330	C. EL 33uF 25V	1900		ケミコン	01
C3061	UR267470	C. EL 47uF 50V	1900		ケミコン	01
C3062-3064	UR247330	C. EL 33uF 25V	1900		ケミコン	01
C3065	US135100	C. CE. CHP 0. 1uF 16V	1900		チップセラコン	01
C3066-3067	UR267100	C. EL 10uF 50V	1900		ケミコン	
C3068	US062100	C. CE. CHP 100pF 50V B	1900		チップセラコン	01
C3071-3076	UR267100	C. EL 10uF 50V	1900		ケミコン	
C3077-3078	UR267470	C. EL 47uF 50V	1900		ケミコン	01
C3079	UR237220	C. EL 22uF 16V	1900		ケミコン	
C3080-3081	UR267100	C. EL 10uF 50V	1900		ケミコン	
C3082	UR237220	C. EL 22uF 16V	1900		ケミコン	
C3083-3084	UR267470	C. EL 47uF 50V	1900		ケミコン	01
C3086	US135100	C. CE. CHP 0. 1uF 16V	1900		チップセラコン	01
C3088	US135100	C. CE. CHP 0. 1uF 16V	1900		チップセラコン	01
C3100-3101	UR237100	C. EL 10uF 16V	1900		ケミコン	
C3500-3501	US135100	C. CE. CHP 0. 1uF 16V	1900		チップセラコン	01
C3503	US062220	C. CE. CHP 220pF 50V B	1900	RTKABGEL	チップセラコン	01
C3504	US062220	C. CE. CHP 220pF 50V B	1900	RTKABGEL	チップセラコン	01
C3506	US062470	C. CE. CHP 470pF 50V B	1900	UCRTKABGEL	チップセラコン	01
C3507	US062470	C. CE. CHP 470pF 50V B	1900	UCRTKABGEL	チップセラコン	01
C3508	US062470	C. CE. CHP 470pF 50V B	1900	UCRTKABGEL	チップセラコン	01
C3509	US062470	C. CE. CHP 470pF 50V B	1900	UCRTKABGEL	チップセラコン	01
C3510-3511	US062220	C. CE. CHP 220pF 50V B	1900		チップセラコン	01
C3512-3513	WJ603100	C. MYLAR 220pF 50V	1900		マイラーコン	01
C3514-3515	US062220	C. CE. CHP 220pF 50V B	1900		チップセラコン	01
C3518	WJ603100	C. MYLAR 220pF 50V	1900		マイラーコン	01
C3519	WJ603300	C. MYLAR 470pF 50V J	1900		マイラーコン	01
C3520-3523	WJ603100	C. MYLAR 220pF 50V	1900		マイラーコン	01
C3526	WJ603300	C. MYLAR 470pF 50V J	1900		マイラーコン	01
C3527	VR169200	C. MYLAR 0. 47uF 50V	1900		マイラーコン	01
C3528-3533	WJ603300	C. MYLAR 470pF 50V J	1900		マイラーコン	01
C3536-3537	UR266220	C. EL 2. 2uF 50V	1900		ケミコン	
C3540-3541	UR218220	C. EL 220uF 6. 3V	1900		ケミコン	
* C3542-3543	WJ605600	C. MYLAR 0. 033uF 50V	1900		マイラーコン	
* C3544-3545	WJ604900	C. MYLAR 9100pF 50V	1900		マイラーコン	
C3546-3548	UR237100	C. EL 10uF 16V	1900		ケミコン	
C3550	UR867100	C. EL 10uF 50V	1900	UCRTKABGEL	ケミコン	01
C3551	UR867100	C. EL 10uF 50V	1900	UCRTKABGEL	ケミコン	01
C3552	UR237100	C. EL 10uF 16V	1900		ケミコン	
C3554	UR867100	C. EL 10uF 50V	1900	UCRTKABGEL	ケミコン	01
C3557	UR867100	C. EL 10uF 50V	1900	UCRTKABGEL	ケミコン	01
C3558	UR237100	C. EL 10uF 16V	1900		ケミコン	
C3559-3560	UR267470	C. EL 47uF 50V	1900		ケミコン	01

* New Parts * 新規部品

RX-V1900/DSP-AX1900

P.C.B. FUNCTION

Ref No.	Part No.	Description	Remarks	Markets	部 品 名	ランク
C3561-3562	WJ603700	C. MYLAR	1000pF 50V	1900		
C3563	UR237100	C. EL	10uF 16V	1900		
C3566	UR248100	C. EL	100uF 25V	1900	UCRTKABGEL	
C3569	UR248100	C. EL	100uF 25V	1900	UCRTKABGEL	
C3570	UR248100	C. EL	100uF 25V	1900	UCRTKABGEL	
C3571	UR266100	C. EL	1uF 50V	1900	UCRTKABGEL	01
C3572	UR248100	C. EL	100uF 25V	1900	UCRTKABGEL	
C3573	UR266100	C. EL	1uF 50V	1900	UCRTKABGEL	01
C3574-3575	UR267470	C. EL	47uF 50V	1900		01
C3576	UR247100	C. EL	10uF 25V	1900	UCRTKABGEL	
C3577	VR168300	C. MYLAR	0. 1uF 50V	1900	UCRTKABGEL	01
C3578	VR168300	C. MYLAR	0. 1uF 50V	1900	UCRTKABGEL	01
C3579	UR247100	C. EL	10uF 25V	1900	UCRTKABGEL	
C3580	UR247100	C. EL	10uF 25V	1900	UCRTKABGEL	
C3581	VR168300	C. MYLAR	0. 1uF 50V	1900	UCRTKABGEL	01
C3582	VR168300	C. MYLAR	0. 1uF 50V	1900	UCRTKABGEL	01
C3583	UR247100	C. EL	10uF 25V	1900	UCRTKABGEL	
C3584-3585	WJ604100	C. MYLAR	2200pF 50V	1900	UCRTKABGEL	
C3586	WJ604100	C. MYLAR	2200pF 50V	1900	UCRTKABGEL	
C3587	WJ604100	C. MYLAR	2200pF 50V	1900	UCRTKABGEL	
C3588	UR247100	C. EL	10uF 25V	1900	UCRTKABGEL	
C3589	UR247100	C. EL	10uF 25V	1900	UCRTKABGEL	
C3590	UR247100	C. EL	10uF 25V	1900	UCRTKABGEL	
C3591	UR247100	C. EL	10uF 25V	1900	UCRTKABGEL	
C3592	UR847100	C. EL	10uF 25V	1900	UCRTKABGEL	01
C3593	UR847100	C. EL	10uF 25V	1900	UCRTKABGEL	01
C3594	UR847100	C. EL	10uF 25V	1900	UCRTKABGEL	01
C3595	UR847100	C. EL	10uF 25V	1900	UCRTKABGEL	01
C3597	US135100	C. CE. CHP	0. 1uF 16V	1900	UCRTKABGEL	01
C3598	UR237100	C. EL	10uF 16V	1900		
C3600	US135100	C. CE. CHP	0. 1uF 16V	1900	UCRTKABGEL	01
C3601	UR237100	C. EL	10uF 16V	1900	UCRTKABGEL	
C3602	US135100	C. CE. CHP	0. 1uF 16V	1900	UCRTKABGEL	01
C3603	UR237470	C. EL	47uF 16V	1900	UCRTKABGEL	01
C3604	UR237100	C. EL	10uF 16V	1900		
C3605-3606	UR237470	C. EL	47uF 16V	1900		01
C3609	US135100	C. CE. CHP	0. 1uF 16V	1900	UCRTKABGEL	01
C3610	UR237100	C. EL	10uF 16V	1900	UCRTKABGEL	
C3615	UR837100	C. EL	10uF 16V	1900	UCRTKABGEL	01
C3616	UR237470	C. EL	47uF 16V	1900	UCRTKABGEL	01
C3617	UR837100	C. EL	10uF 16V	1900	UCRTKABGEL	01
C3619	US135100	C. CE. CHP	0. 1uF 16V	1900	UCRTKABGEL	01
C3622	UR237100	C. EL	10uF 16V	1900	UCRTKABGEL	
C3623	UR237100	C. EL	10uF 16V	1900	UCRTKABGEL	
C3632	US135100	C. CE. CHP	0. 1uF 16V	1900	UCRTKABGEL	01
C3633	US135100	C. CE. CHP	0. 1uF 16V	1900	UCRTKABGEL	01
C3634	US135100	C. CE. CHP	0. 1uF 16V	1900	UCRTKABGEL	01
C3635	US135100	C. CE. CHP	0. 1uF 16V	1900	UCRTKABGEL	01
C3636-3639	US135100	C. CE. CHP	0. 1uF 16V	1900		01
C4018	US064100	C. CE. CHP	0. 01uF 50V B	1900	JCRTKABGEL	01
C4019	UR266220	C. EL	2. 2uF 50V	1900	JCRTKABGEL	
C4020	UU238100	C. EL	100uF 16V	1900	JCRTKABGEL	01
C4021	US135100	C. CE. CHP	0. 1uF 16V	1900	BGE	01
C4022-4023	US062330	C. CE. CHP	330pF 50V B	1900	BGE	01
C4024	US062560	C. CE. CHP	560pF 50V B	1900	BGE	01

* New Parts * 新規部品

RX-V1900/DSP-AX1900

P.C.B. FUNCTION

Ref No.	Part No.	Description	Remarks	Markets	部 品 名	ランク
C4025-4026	UR237470	C. EL 47uF 16V	1900	BGE	ケミコン	01
C4027-4028	US061270	C. CE. CHP 27pF 50V B	1900	BGE	チップセラコン	01
C4029	UR237470	C. EL 47uF 16V	1900	BGE	ケミコン	01
C4030	US135100	C. CE. CHP 0. 1uF 16V	1900	BGE	チップセラコン	01
C4031-4034	US135100	C. CE. CHP 0. 1uF 16V	1900		チップセラコン	01
C4036-4039	US135100	C. CE. CHP 0. 1uF 16V	1900		チップセラコン	01
C4040	UR239100	C. EL 1000uF 16V	1900		ケミコン	
C4041-4044	US135100	C. CE. CHP 0. 1uF 16V	1900		チップセラコン	01
C4045	US063100	C. CE. CHP 1000pF 50V B	1900		チップセラコン	01
C4046	US135100	C. CE. CHP 0. 1uF 16V	1900		チップセラコン	01
C4048-4049	US135100	C. CE. CHP 0. 1uF 16V	1900		チップセラコン	01
C4050	UR267100	C. EL 10uF 50V	1900		ケミコン	
C4051	US135100	C. CE. CHP 0. 1uF 16V	1900		チップセラコン	01
C4052	WB165500	C. EL 0. 33F 5. 5V	1900		ゴールドキャパシタ	04
C4053-4055	UR219100	C. EL 1000uF 6. 3V	1900		ケミコン	
C4056-4061	US135100	C. CE. CHP 0. 1uF 16V	1900		チップセラコン	01
C4062	US064100	C. CE. CHP 0. 01uF 50V B	1900		チップセラコン	01
C4063	US135100	C. CE. CHP 0. 1uF 16V	1900		チップセラコン	01
C4064	UR266220	C. EL 2. 2uF 50V	1900	UCRTKABGEL	ケミコン	
C4065	UR266220	C. EL 2. 2uF 50V	1900	UCRTKABGEL	ケミコン	
C4066-4070	UR266220	C. EL 2. 2uF 50V	1900		ケミコン	
C4071	UR239100	C. EL 1000uF 16V	1900		ケミコン	
C4072	US135100	C. CE. CHP 0. 1uF 16V	1900	UCRTKABGEL	チップセラコン	01
C4073	UR218100	C. EL 100uF 6. 3V	1900	UCRTKABGEL	ケミコン	
C4074	US063100	C. CE. CHP 1000pF 50V B	1900	UCRTKABGEL	チップセラコン	01
C4075	US063100	C. CE. CHP 1000pF 50V B	1900	UCRTKABGEL	チップセラコン	01
C4076-4077	US135100	C. CE. CHP 0. 1uF 16V	1900		チップセラコン	01
C4081	US063100	C. CE. CHP 1000pF 50V B	1900	UCRTKABGEL	チップセラコン	01
C4082-4087	US062100	C. CE. CHP 100pF 50V B	1900		チップセラコン	01
C4089	US062100	C. CE. CHP 100pF 50V B	1900		チップセラコン	01
C4098-4103	US062100	C. CE. CHP 100pF 50V B	1900		チップセラコン	01
C4114	US062100	C. CE. CHP 100pF 50V B	1900		チップセラコン	01
C4115	US135100	C. CE. CHP 0. 1uF 16V	1900		チップセラコン	01
C4131	US135100	C. CE. CHP 0. 1uF 16V	1900		チップセラコン	01
C4134	US061470	C. CE. CHP 47pF 50V B	1900		チップセラコン	01
C4500-4505	US062220	C. CE. CHP 220pF 50V B	1900		チップセラコン	01
C4506-4507	US062100	C. CE. CHP 100pF 50V B	1900		チップセラコン	01
C4508-4509	WJ603100	C. MYLAR 220pF 50V	1900		マイラーコン	01
C4510-4511	US062220	C. CE. CHP 220pF 50V B	1900		チップセラコン	01
C4512-4513	US062100	C. CE. CHP 100pF 50V B	1900		チップセラコン	01
C4514-4515	US062220	C. CE. CHP 220pF 50V B	1900		チップセラコン	01
C4516-4517	US062100	C. CE. CHP 100pF 50V B	1900		チップセラコン	01
C4518	UR237100	C. EL 10uF 16V	1900		ケミコン	
C4520	UR237100	C. EL 10uF 16V	1900	UCRTKABGEL	ケミコン	
C4521	UR237100	C. EL 10uF 16V	1900	UCRTKABGEL	ケミコン	
C4522	UR237100	C. EL 10uF 16V	1900		ケミコン	
C4523	UR237100	C. EL 10uF 16V	1900	UCRTKABGEL	ケミコン	
C4524	UR237100	C. EL 10uF 16V	1900		ケミコン	
C4528	UR237100	C. EL 10uF 16V	1900	UCRTKABGEL	ケミコン	
C4529	UR237100	C. EL 10uF 16V	1900		ケミコン	
C4530-4531	UR237470	C. EL 47uF 16V	1900		ケミコン	01
C4536-4539	US135100	C. CE. CHP 0. 1uF 16V	1900		チップセラコン	01
D3000-3003	VT332900	DIODE 1SS355	1900		ダイオード	01
D3004-3005	VU993800	DIODE. ZENR MA8068-M 6. 8V	1900		ツェナーダイオード	01
D3500-3501	VU992100	DIODE. ZENR MA8047-L 4. 6V	1900		ツェナーダイオード	01

* New Parts * 新規部品

RX-V1900/DSP-AX1900

P.C.B. FUNCTION

Ref No.	Part No.	Description	Remarks	Markets	部 品 名	ランク	
D3502	VT332900	DIODE	1SS355	1900	UCRTKABGEL	ダイオード	01
D3503	VT332900	DIODE	1SS355	1900	UCRTKABGEL	ダイオード	01
D4001	VU172000	DIODE. ZENR	UDZS5. 6BTE-17 5. 6V	1900	JCRTKABGEL	ツェナーダイオード	01
D4002-4007	VT332900	DIODE	1SS355	1900		ダイオード	01
D4008	VV833200	DIODE	1SS380	1900		ダイオード	01
D4009	VT332900	DIODE	1SS355	1900		ダイオード	01
D4010	VU992600	DIODE. ZENR	MA8051-M 5. 1V	1900		ツェナーダイオード	01
D4011-4013	VT332900	DIODE	1SS355	1900		ダイオード	01
D4014	V2598200	LED	S1R-505ST	1900	UCRTKABGEL	LED	01
D4016	VT332900	DIODE	1SS355	1900	UCRTKABGEL	ダイオード	01
IC300	X5045A00	IC	NJU7312AM	1900		アナログ I C	05
IC301	X5044A00	IC	NJU7311AM	1900		アナログ I C	05
IC302	X7378A00	IC	NJM4565M (TE1)	1900		アンプ I C	01
IC304-306	X7378A00	IC	NJM4565M (TE1)	1900		アンプ I C	01
IC307	X5574A00	IC	YAC526-EZE2	1900		I C アナログ	05
IC308	X4325A00	IC	YAC523-EVR2	1900		I C, アナログ	06
IC309	X7378A00	IC	NJM4565M (TE1)	1900		アンプ I C	01
IC310	X7378A00	IC	NJM4565M (TE1)	1900	JRTKABGEL	アンプ I C	01
IC311	X7378A00	IC	NJM4565M (TE1)	1900	JRTKABGEL	アンプ I C	01
IC312	X7378A00	IC	NJM4565M (TE1)	1900		アンプ I C	01
IC313	X5043A00	IC	NJU7313AM	1900		アナログ I C	05
IC350	X3505A00	IC	NJM2068MD-TE2	1900		アンプ I C	02
IC351	X7378A00	IC	NJM4565M (TE1)	1900		アンプ I C	01
IC355	X3547A00	IC	BD3841FS	1900		I C	06
IC356	X3547A00	IC	BD3841FS	1900	UCRTKABGEL	I C	06
IC357	X5574A00	IC	YAC526-EZE2	1900	UCRTKABGEL	I C アナログ	05
IC358	X5574A00	IC	YAC526-EZE2	1900	UCRTKABGEL	I C アナログ	05
* IC359-360	X7785B00	IC	NJW1119AV (TE1)	1900	UCRTKABGEL	トーンコントロール I C	
* IC401	X0082A00	IC	LC72722PM	1900	BGE	I C	
* IC402	YA018A00	IC. CPU	M3087BFLBGP CPU	written	JRTKABGEL	I C CPU	
* IC402	YA395A00	IC. CPU	M3087BFLBGP CPU	written	U	I C CPU	
* IC402	YA396A00	IC. CPU	M3087BFLBGP CPU	written	C	I C CPU	
IC403	X7779A00	IC	LC709004A-TLM-E	1900		ロジック I C	04
IC404	XW814A00	IC	TC7SET32FU	1900		ロジック I C	01
IC405	X3833A00	IC	SN74AHC1G08DCKR	1900		ロジック I C	01
IC406	XW814A00	IC	TC7SET32FU	1900		ロジック I C	01
IC407	X5886A00	IC	RH5RE58AA-T1-FA	1900		電源 I C	04
IC450	X3547A00	IC	BD3841FS	1900	UCRTKABGEL	I C	06
IC451	X3547A00	IC	BD3841FS	1900		I C	06
JK401	V9435700	JACK. MNI	MSJ-035-12APC	1900	UCRTKABGEL	モノラル ミニジャック	01
JK402	V9435700	JACK. MNI	MSJ-035-12APC	1900	UCRTKABGEL	モノラル ミニジャック	01
PJ350	V5478700	JACK. PIN	4P RJ-1073F-09	1900		ピンジャック	
PJ352	V5478900	JACK. PIN	RJ-1074-84-0353A	1900		ピンジャック 6 P	03
PJ353	VV325400	JACK. PIN	6P	1900		ピンジャック	05
PJ354	VV306900	JACK. PIN	4P	1900	UCRTKABGEL	ピンジャック	02
* PJ355	WQ364800	JACK. PIN	2P	1900		ピンジャック	
* PJ356	WQ354100	JACK. PIN	2P	1900		ピンジャック	
PJ450	VV306900	JACK. PIN	4P	1900		ピンジャック	02
PJ451	VV325400	JACK. PIN	6P	1900		ピンジャック	05
PJ452-453	VV306900	JACK. PIN	4P	1900		ピンジャック	02
PN301-302	V9637500	PIN	L=70 #18	1900		スタイルピン	
PN450	V9637500	PIN	L=70 #18	1900		スタイルピン	
Q3000	WG408900	TR	2SC5291 S, T	1900		トランジスタ	03
Q3001	WG408800	TR	2SA2168 S, T	1900		トランジスタ	03
Q3002-3017	VZ725900	TR	2SD1938F S, T	1900		トランジスタ	01

* New Parts * 新規部品

RX-V1900/DSP-AX1900	HTR-6290
---------------------	----------

P.C.B. FUNCTION

Ref No.	Part No.	Description	Remarks	Markets	部 品 名	ランク	
Q3500-3501	VZ725900	TR	2SD1938F S, T	1900	UCRTKABGEL	トランジスタ	01
Q3502	VZ725900	TR	2SD1938F S, T	1900	UCRTKABGEL	トランジスタ	01
Q3503	VZ725900	TR	2SD1938F S, T	1900	UCRTKABGEL	トランジスタ	01
Q3504	VZ725900	TR	2SD1938F S, T	1900	UCRTKABGEL	トランジスタ	01
Q3505	VZ725900	TR	2SD1938F S, T	1900	UCRTKABGEL	トランジスタ	01
Q3506	VZ725900	TR	2SD1938F S, T	1900	UCRTKABGEL	トランジスタ	01
Q3507	VZ725900	TR	2SD1938F S, T	1900	UCRTKABGEL	トランジスタ	01
Q4001	VD303700	TR	2SC3326 A, B	1900	JCRTKABGEL	トランジスタ	01
Q4002	iC181510	TR	2SC1815 Y	1900	JCRTKABGEL	トランジスタ	01
Q4003	VD303700	TR	2SC3326 A, B	1900	BGE	トランジスタ	01
Q4004	VD303700	TR	2SC3326 A, B	1900		トランジスタ	01
Q4005	WD974200	TR	2SA1036KT146 P, Q, R	1900		トランジスタ	01
Q4006	VV556500	TR	2SA1037K Q, R, S	1900		トランジスタ	01
Q4007-4008	VD303700	TR	2SC3326 A, B	1900		トランジスタ	01
Q4009	iC287820	TR	2SC2878 A, B	1900		トランジスタ	01
Q4010	WF767900	FET	5HP01C-TB-E	1900	UCRTKABGEL	F E T	01
Q4011	WF767900	FET	5HP01C-TB-E	1900	UCRTKABGEL	F E T	01
Q4012-4016	WF767900	FET	5HP01C-TB-E	1900		F E T	01
Q4021	VV556400	TR	2SC2412K Q, R, S	1900	UC	トランジスタ	01
R3102	HF355680	R. CAR	680 Ω 1/2W	1900		カーボン抵抗	
R3136-3137	WQ072300	R. MTL. OXD	2.2 Ω 1W	1900		酸化金属被膜抵抗	
R3138	HV753470	R. CAR. FP	4.7 Ω 1/4W	1900		不燃化カーボン抵抗	01
R3508	HF355470	R. CAR	470 Ω 1/2W	1900	UCRTKABGEL	カーボン抵抗	
R3509	HF355470	R. CAR	470 Ω 1/2W	1900	UCRTKABGEL	カーボン抵抗	
R3510	HF355470	R. CAR	470 Ω 1/2W	1900	UCRTKABGEL	カーボン抵抗	
R3511	HF355470	R. CAR	470 Ω 1/2W	1900	UCRTKABGEL	カーボン抵抗	
R3526-3533	HF354470	R. CAR	47 Ω 1/2W	1900		カーボン抵抗	
* R3597-3598	WQ835800	R. MTL. OXD	100 Ω 1W	1900	JBGE	酸化金属被膜抵抗	
R3597-3598	HV755100	R. CAR. FP	100 Ω 1/4W	1900	UCRTKAL	不燃化カーボン抵抗	01
R4065	V8070300	R. MTL. FLM	10 Ω 1W	1900		金属被膜抵抗	
ST300	V4040500	SCR. TERM	M3	1900		スクリュー／ターミナル	01
ST401	V4040500	SCR. TERM	M3	1900		スクリュー／ターミナル	01
ST402	WK497300	SCR. TERM	M3 3P	1900		スクリューターミナル	02
ST403	V4040500	SCR. TERM	M3	1900		スクリュー／ターミナル	01
U4001	V8210200	L. DTCT	GP1UD271XK	1900	UCRTKABGEL	リモコン受光ユニット	03
* XL401	V7556000	RSNR. CRY	4.332MHz HC-49U	1900	BGE	水晶振動子	
XL402	WF997400	RSNR. CE	20MHz	1900		セラミック振動子	02
* * * * *	WP410000	P. C. B.	FUNCTION	6290	C	PCB FUNCTION	
* * * * *	WP410100	P. C. B.	FUNCTION	6290	G	PCB FUNCTION	
CB300	VQ048000	CN. BS. PIN	31P	6290		FFCコネクタ	02
CB301	V8809800	CN. JE	9P SE	6290		JEコネクタプラグ	01
CB302	V8875300	CN. JE	13P SE	6290		JEコネクタプラグ	01
CB303	VC166500	CN. BS. PIN	12P	6290		コネクタベースポスト	01
CB350	V8809800	CN. JE	9P SE	6290		JEコネクタプラグ	01
CB351	V7827000	CN	20P TE TUC SERIES	6290		コネクタプラグ	01
CB401	VM859600	CN. BS. PIN	15P	6290		FFCコネクタ	01
CB402-403	V8875300	CN. JE	13P SE	6290		JEコネクタプラグ	01
CB404	V8809800	CN. JE	9P SE	6290		JEコネクタプラグ	01
CB405	VB389600	CN. BS. PIN	11P	6290		コネクタベースポスト	01
CB406	VB858700	CN. BS. PIN	8P	6290		ベースピン	01
CB407	VB858800	CN. BS. PIN	9P	6290		ベースピン	01
CB408	VQ044200	CN. BS. PIN	6P	6290		FFCコネクタ	01

* New Parts * 新規部品

HTR-6290

P.C.B. FUNCTION

Ref No.	Part No.	Description	Remarks	Markets	部 品 名	ランク
CB409	VF982200	CN. BS. PIN	14P	6290	コネクタ	02
CB410	VM859500	CN. BS. PIN	11P	6290	F F Cコネクタ	01
CB411	VQ044300	CN. BS. PIN	7P	6290	F F Cコネクタ	01
CB412-414	V9356900	CN. JE	19P SE	6290	J Eコネクタプラグ	
CB416	V8809800	CN. JE	9P SE	6290	J Eコネクタプラグ	01
CB453	V7828700	SOCKET	20P SE TUC SERIES	6290	コネクタソケット	01
C3000-3001	UR237100	C. EL	10uF 16V	6290	ケミコン	
C3002	US135220	C. CE. CHP	0. 22uF 16V	6290	チップセラコン	01
C3003-3004	US135100	C. CE. CHP	0. 1uF 16V	6290	チップセラコン	01
C3005-3006	UR267470	C. EL	47uF 50V	6290	ケミコン	01
C3007-3008	UR267100	C. EL	10uF 50V	6290	ケミコン	
C3009	US135100	C. CE. CHP	0. 1uF 16V	6290	チップセラコン	01
C3010-3011	UR267100	C. EL	10uF 50V	6290	ケミコン	
C3013-3016	UR267100	C. EL	10uF 50V	6290	ケミコン	
C3017-3018	UR238100	C. EL	100uF 16V	6290	ケミコン	
C3020-3023	UR238100	C. EL	100uF 16V	6290	ケミコン	
C3024-3025	US062100	C. CE. CHP	100pF 50V B	6290	チップセラコン	01
C3026-3027	WP420700	C. PP	100pF 100V	6290	P Pコン	
C3029	US135100	C. CE. CHP	0. 1uF 16V	6290	チップセラコン	01
C3030-3033	US062100	C. CE. CHP	100pF 50V B	6290	チップセラコン	01
C3035	UR266470	C. EL	4. 7uF 50V	6290	ケミコン	
C3036-3037	UR267470	C. EL	47uF 50V	6290	ケミコン	01
C3038-3039	UR266470	C. EL	4. 7uF 50V	6290	ケミコン	
C3040	UR237100	C. EL	10uF 16V	6290	ケミコン	
C3041-3042	UR266470	C. EL	4. 7uF 50V	6290	ケミコン	
C3043-3044	UR266330	C. EL	3. 3uF 50V	6290	ケミコン	
C3045-3050	US135100	C. CE. CHP	0. 1uF 16V	6290	チップセラコン	01
C3051	UR267470	C. EL	47uF 50V	6290	ケミコン	01
C3052	US135100	C. CE. CHP	0. 1uF 16V	6290	チップセラコン	01
C3053	UR247330	C. EL	33uF 25V	6290	ケミコン	01
C3054	UR267470	C. EL	47uF 50V	6290	ケミコン	01
C3055	UR267100	C. EL	10uF 50V	6290	ケミコン	
C3056	UR247330	C. EL	33uF 25V	6290	ケミコン	01
C3057	UR267470	C. EL	47uF 50V	6290	ケミコン	01
C3058	UR247330	C. EL	33uF 25V	6290	ケミコン	01
C3059	UR237100	C. EL	10uF 16V	6290	ケミコン	
C3060	UR247330	C. EL	33uF 25V	6290	ケミコン	01
C3061	UR267470	C. EL	47uF 50V	6290	ケミコン	01
C3062-3064	UR247330	C. EL	33uF 25V	6290	ケミコン	01
C3065	US135100	C. CE. CHP	0. 1uF 16V	6290	チップセラコン	01
C3066-3067	UR267100	C. EL	10uF 50V	6290	ケミコン	
C3068	US062100	C. CE. CHP	100pF 50V B	6290	チップセラコン	01
C3071-3076	UR267100	C. EL	10uF 50V	6290	ケミコン	
C3077-3078	UR267470	C. EL	47uF 50V	6290	ケミコン	01
C3079	UR237220	C. EL	22uF 16V	6290	ケミコン	
C3080-3081	UR267100	C. EL	10uF 50V	6290	ケミコン	
C3082	UR237220	C. EL	22uF 16V	6290	ケミコン	
C3083-3084	UR267470	C. EL	47uF 50V	6290	ケミコン	01
C3086	US135100	C. CE. CHP	0. 1uF 16V	6290	チップセラコン	01
C3088	US135100	C. CE. CHP	0. 1uF 16V	6290	チップセラコン	01
C3100-3101	UR237100	C. EL	10uF 16V	6290	ケミコン	
C3500-3501	US135100	C. CE. CHP	0. 1uF 16V	6290	チップセラコン	01
C3503-3504	US062220	C. CE. CHP	220pF 50V B	6290	チップセラコン	01
C3506-3509	US062470	C. CE. CHP	470pF 50V B	6290	チップセラコン	01
C3510-3511	US062220	C. CE. CHP	220pF 50V B	6290	チップセラコン	01

* New Parts * 新規部品

HTR-6290

P.C.B. FUNCTION

Ref No.	Part No.	Description	Remarks	Markets	部 品 名	ランク
C3512-3513	WJ603100	C. MYLAR	220pF 50V	6290	マイラーコン	01
C3514-3515	US062220	C. CE. CHP	220pF 50V B	6290	チップセラコン	01
C3518	WJ603100	C. MYLAR	220pF 50V	6290	マイラーコン	01
C3519	WJ603300	C. MYLAR	470pF 50V J	6290	マイラーコン	01
C3520-3523	WJ603100	C. MYLAR	220pF 50V	6290	マイラーコン	01
C3526	WJ603300	C. MYLAR	470pF 50V J	6290	マイラーコン	01
C3527	VR169200	C. MYLAR	0. 47uF 50V	6290	マイラーコン	01
C3528-3533	WJ603300	C. MYLAR	470pF 50V J	6290	マイラーコン	01
C3536-3537	UR266220	C. EL	2. 2uF 50V	6290	ケミコン	
C3540-3541	UR218220	C. EL	220uF 6. 3V	6290	ケミコン	
* C3542-3543	WJ605600	C. MYLAR	0. 033uF 50V	6290	マイラーコン	
* C3544-3545	WJ604900	C. MYLAR	9100pF 50V	6290	マイラーコン	
C3546-3548	UR237100	C. EL	10uF 16V	6290	ケミコン	
C3550-3551	UR867100	C. EL	10uF 50V	6290	ケミコン	01
C3552	UR237100	C. EL	10uF 16V	6290	ケミコン	
C3554	UR867100	C. EL	10uF 50V	6290	ケミコン	01
C3557	UR867100	C. EL	10uF 50V	6290	ケミコン	01
C3558	UR237100	C. EL	10uF 16V	6290	ケミコン	
C3559-3560	UR267470	C. EL	47uF 50V	6290	ケミコン	01
C3561-3562	WJ603700	C. MYLAR	1000pF 50V	6290	マイラーコン	
C3563	UR237100	C. EL	10uF 16V	6290	ケミコン	
C3566	UR248100	C. EL	100uF 25V	6290	ケミコン	
C3569-3570	UR248100	C. EL	100uF 25V	6290	ケミコン	
C3571	UR266100	C. EL	1uF 50V	6290	ケミコン	01
C3572	UR248100	C. EL	100uF 25V	6290	ケミコン	
C3573	UR266100	C. EL	1uF 50V	6290	ケミコン	01
C3574-3575	UR267470	C. EL	47uF 50V	6290	ケミコン	01
C3576	UR247100	C. EL	10uF 25V	6290	ケミコン	
C3577-3578	VR168300	C. MYLAR	0. 1uF 50V	6290	マイラーコン	01
C3579-3580	UR247100	C. EL	10uF 25V	6290	ケミコン	
C3581-3582	VR168300	C. MYLAR	0. 1uF 50V	6290	マイラーコン	01
C3583	UR247100	C. EL	10uF 25V	6290	ケミコン	
C3584-3587	WJ604100	C. MYLAR	2200pF 50V	6290	マイラーコン	
C3588-3591	UR247100	C. EL	10uF 25V	6290	ケミコン	
C3592-3595	UR847100	C. EL	10uF 25V	6290	ケミコン	01
C3597	US135100	C. CE. CHP	0. 1uF 16V	6290	チップセラコン	01
C3598	UR237100	C. EL	10uF 16V	6290	ケミコン	
C3600	US135100	C. CE. CHP	0. 1uF 16V	6290	チップセラコン	01
C3601	UR237100	C. EL	10uF 16V	6290	ケミコン	
C3602	US135100	C. CE. CHP	0. 1uF 16V	6290	チップセラコン	01
C3603	UR237470	C. EL	47uF 16V	6290	ケミコン	01
C3604	UR237100	C. EL	10uF 16V	6290	ケミコン	
C3605-3606	UR237470	C. EL	47uF 16V	6290	ケミコン	01
C3609	US135100	C. CE. CHP	0. 1uF 16V	6290	チップセラコン	01
C3610	UR237100	C. EL	10uF 16V	6290	ケミコン	
C3615	UR837100	C. EL	10uF 16V	6290	ケミコン	01
C3616	UR237470	C. EL	47uF 16V	6290	ケミコン	01
C3617	UR837100	C. EL	10uF 16V	6290	ケミコン	01
C3619	US135100	C. CE. CHP	0. 1uF 16V	6290	チップセラコン	01
C3622-3623	UR237100	C. EL	10uF 16V	6290	ケミコン	
C3632-3639	US135100	C. CE. CHP	0. 1uF 16V	6290	チップセラコン	01
C4018	US064100	C. CE. CHP	0. 01uF 50V B	6290	チップセラコン	01
C4019	UR266220	C. EL	2. 2uF 50V	6290	ケミコン	
C4020	UU238100	C. EL	100uF 16V	6290	ケミコン	01
C4021	US135100	C. CE. CHP	0. 1uF 16V	6290	G チップセラコン	01

* New Parts * 新規部品

HTR-6290

P.C.B. FUNCTION

Ref No.	Part No.	Description	Remarks	Markets	部 品 名	ランク	
C4022-4023	US062330	C. CE. CHP	330pF 50V B	6290	G	チップセラコン	01
C4024	US062560	C. CE. CHP	560pF 50V B	6290	G	チップセラコン	01
C4025-4026	UR237470	C. EL	47uF 16V	6290	G	ケミコン	01
C4027-4028	US061270	C. CE. CHP	27pF 50V B	6290	G	チップセラコン	01
C4029	UR237470	C. EL	47uF 16V	6290	G	ケミコン	01
C4030	US135100	C. CE. CHP	0. 1uF 16V	6290	G	チップセラコン	01
C4031-4034	US135100	C. CE. CHP	0. 1uF 16V	6290		チップセラコン	01
C4036-4039	US135100	C. CE. CHP	0. 1uF 16V	6290		チップセラコン	01
C4040	UR239100	C. EL	1000uF 16V	6290		ケミコン	
C4041-4044	US135100	C. CE. CHP	0. 1uF 16V	6290		チップセラコン	01
C4045	US063100	C. CE. CHP	1000pF 50V B	6290		チップセラコン	01
C4046	US135100	C. CE. CHP	0. 1uF 16V	6290		チップセラコン	01
C4048-4049	US135100	C. CE. CHP	0. 1uF 16V	6290		チップセラコン	01
C4050	UR267100	C. EL	10uF 50V	6290		ケミコン	
C4051	US135100	C. CE. CHP	0. 1uF 16V	6290		チップセラコン	01
C4052	WB165500	C. EL	0. 33F 5. 5V	6290		ゴールドキャパシタ	04
C4053-4055	UR219100	C. EL	1000uF 6. 3V	6290		ケミコン	
C4056-4061	US135100	C. CE. CHP	0. 1uF 16V	6290		チップセラコン	01
C4062	US064100	C. CE. CHP	0. 01uF 50V B	6290		チップセラコン	01
C4063	US135100	C. CE. CHP	0. 1uF 16V	6290		チップセラコン	01
C4064-4070	UR266220	C. EL	2. 2uF 50V	6290		ケミコン	
C4071	UR239100	C. EL	1000uF 16V	6290		ケミコン	
C4072	US135100	C. CE. CHP	0. 1uF 16V	6290		チップセラコン	01
C4073	UR218100	C. EL	100uF 6. 3V	6290		ケミコン	
C4074-4075	US063100	C. CE. CHP	1000pF 50V B	6290		チップセラコン	01
C4076-4077	US135100	C. CE. CHP	0. 1uF 16V	6290		チップセラコン	01
C4081	US063100	C. CE. CHP	1000pF 50V B	6290		チップセラコン	01
C4082-4087	US062100	C. CE. CHP	100pF 50V B	6290		チップセラコン	01
C4089	US062100	C. CE. CHP	100pF 50V B	6290		チップセラコン	01
C4098-4103	US062100	C. CE. CHP	100pF 50V B	6290		チップセラコン	01
C4114	US062100	C. CE. CHP	100pF 50V B	6290		チップセラコン	01
C4115	US135100	C. CE. CHP	0. 1uF 16V	6290		チップセラコン	01
C4131	US135100	C. CE. CHP	0. 1uF 16V	6290		チップセラコン	01
C4134	US061470	C. CE. CHP	47pF 50V B	6290		チップセラコン	01
C4500-4505	US062220	C. CE. CHP	220pF 50V B	6290		チップセラコン	01
C4506-4507	US062100	C. CE. CHP	100pF 50V B	6290		チップセラコン	01
C4508-4509	WJ603100	C. MYLAR	220pF 50V	6290		マイラーコン	01
C4510-4511	US062220	C. CE. CHP	220pF 50V B	6290		チップセラコン	01
C4512-4513	US062100	C. CE. CHP	100pF 50V B	6290		チップセラコン	01
C4514-4515	US062220	C. CE. CHP	220pF 50V B	6290		チップセラコン	01
C4516-4517	US062100	C. CE. CHP	100pF 50V B	6290		チップセラコン	01
C4518-4529	UR237100	C. EL	10uF 16V	6290		ケミコン	
C4530-4531	UR237470	C. EL	47uF 16V	6290		ケミコン	01
C4536-4539	US135100	C. CE. CHP	0. 1uF 16V	6290		チップセラコン	01
D3000-3003	VT332900	DIODE	1SS355	6290		ダイオード	01
D3004-3005	VU993800	DIODE. ZENR	MA8068-M 6. 8V	6290		ツェナーダイオード	01
D3500-3501	VU992100	DIODE. ZENR	MA8047-L 4. 6V	6290		ツェナーダイオード	01
D3502-3503	VT332900	DIODE	1SS355	6290		ダイオード	01
D4001	VU172000	DIODE. ZENR	UDZS5. 6BTE-17 5. 6V	6290		ツェナーダイオード	01
D4002-4007	VT332900	DIODE	1SS355	6290		ダイオード	01
D4008	VV833200	DIODE	1SS380	6290		ダイオード	01
D4009	VT332900	DIODE	1SS355	6290		ダイオード	01
D4010	VU992600	DIODE. ZENR	MA8051-M 5. 1V	6290		ツェナーダイオード	01
D4011-4013	VT332900	DIODE	1SS355	6290		ダイオード	01
D4014	V2598200	LED	SIR-505ST	6290		LED	01

* New Parts * 新規部品

HTR-6290

P.C.B. FUNCTION

Ref No.	Part No.	Description	Remarks	Markets	部 品 名	ランク	
D4016	VT332900	DIODE	1SS355	6290		ダイオード	01
IC300	X5045A00	IC	NJU7312AM	6290		アナログ I C	05
IC301	X5044A00	IC	NJU7311AM	6290		アナログ I C	05
IC302	X7378A00	IC	NJM4565M (TE1)	6290		アンプ I C	01
IC304-306	X7378A00	IC	NJM4565M (TE1)	6290		アンプ I C	01
IC307	X5574A00	IC	YAC526-EZE2	6290		I C アナログ	05
IC308	X4325A00	IC	YAC523-EVR2	6290		I C, アナログ	06
IC309	X7378A00	IC	NJM4565M (TE1)	6290		アンプ I C	01
IC310-311	X7378A00	IC	NJM4565M (TE1)	6290	G	アンプ I C	01
IC312	X7378A00	IC	NJM4565M (TE1)	6290		アンプ I C	01
IC313	X5043A00	IC	NJU7313AM	6290		アナログ I C	05
IC350	X3505A00	IC	NJM2068MD-TE2	6290		アンプ I C	02
IC351	X7378A00	IC	NJM4565M (TE1)	6290		アンプ I C	01
IC355-356	X3547A00	IC	BD3841FS	6290		I C	06
IC357-358	X5574A00	IC	YAC526-EZE2	6290		I C アナログ	05
* IC359-360	X7785B00	IC	NJW1119AV (TE1)	6290		トーンコントロール I C	
IC401	X0082A00	IC	LC72722PM	6290	G	I C	
* IC402	YA395A00	IC. CPU	M3087BFLBGP CPU	written	C	I C CPU	
* IC402	YA018A00	IC. CPU	M3087BFLBGP CPU	written	G	I C CPU	
IC403	X7779A00	IC	LC709004A-TLM-E	6290		ロジック I C	04
IC404	XW814A00	IC	TC7SET32FU	6290		ロジック I C	01
IC405	X3833A00	IC	SN74AHC1G08DCKR	6290		ロジック I C	01
IC406	XW814A00	IC	TC7SET32FU	6290		ロジック I C	01
IC407	X5886A00	IC	RH5RE58AA-T1-FA	6290		電源 I C	04
IC450-451	X3547A00	IC	BD3841FS	6290		I C	06
JK401-402	V9435700	JACK. MNI	MSJ-035-12APC	6290		モノラル ミニジャック	01
PJ350	V5478700	JACK. PIN	4P RJ-1073F-09	6290		ピンジャック	
PJ352	V5478900	JACK. PIN	RJ-1074-84-0353A	6290		ピンジャック 6 P	03
PJ353	VV325400	JACK. PIN	6P	6290		ピンジャック	05
PJ354	VV306900	JACK. PIN	4P	6290		ピンジャック	02
* PJ355	WQ364800	JACK. PIN	2P	6290		ピンジャック	
* PJ356	WQ354100	JACK. PIN	2P	6290		ピンジャック	
PJ450	VV306900	JACK. PIN	4P	6290		ピンジャック	02
PJ451	VV325400	JACK. PIN	6P	6290		ピンジャック	05
PJ452-453	VV306900	JACK. PIN	4P	6290		ピンジャック	02
PN301-302	V9637500	PIN	L=70 #18	6290		スタイルピン	
PN450	V9637500	PIN	L=70 #18	6290		スタイルピン	
Q3000	WG408900	TR	2SC5291 S, T	6290		トランジスタ	03
Q3001	WG408800	TR	2SA2168 S, T	6290		トランジスタ	03
Q3002-3017	VZ725900	TR	2SD1938F S, T	6290		トランジスタ	01
Q3500-3507	VZ725900	TR	2SD1938F S, T	6290		トランジスタ	01
Q4001	VD303700	TR	2SC3326 A, B	6290		トランジスタ	01
Q4002	iC181510	TR	2SC1815 Y	6290		トランジスタ	01
Q4003	VD303700	TR	2SC3326 A, B	6290	G	トランジスタ	01
Q4004	VD303700	TR	2SC3326 A, B	6290		トランジスタ	01
Q4005	WD974200	TR	2SA1036KT146 P, Q, R	6290		トランジスタ	01
Q4006	VV556500	TR	2SA1037K Q, R, S	6290		トランジスタ	01
Q4007-4008	VD303700	TR	2SC3326 A, B	6290		トランジスタ	01
Q4009	iC287820	TR	2SC2878 A, B	6290		トランジスタ	01
Q4010-4016	WF767900	FET	5HP01C-TB-E	6290		F E T	01
Q4021	VV556400	TR	2SC2412K Q, R, S	6290	C	トランジスタ	01
R3102	HF355680	R. CAR	680 Ω 1/2W	6290		カーボン抵抗	
R3136-3137	WQ072300	R. MTL. OXD	2. 2 Ω 1W	6290		酸化金属被膜抵抗	
R3138	HV753470	R. CAR. FP	4. 7 Ω 1/4W	6290		不燃化カーボン抵抗	01
R3508-3511	HF355470	R. CAR	470 Ω 1/2W	6290		カーボン抵抗	

* New Parts * 新規部品

HTR-6290

P.C.B. FUNCTION and P.C.B. OPERATION

Ref No.	Part No.	Description	Remarks	Markets	部 品 名	ランク
R3526-3533	HF354470	R. CAR	47 Ω 1/2W	6290		カーボン抵抗
R3597-3598	HV755100	R. CAR. FP	100 Ω 1/4W	6290	C	不燃化カーボン抵抗
R3597-3598	WQ835800	R. MTL. OXD	100 Ω 1W	1900	G	酸化金属被膜抵抗
R4065	V8070300	R. MTL. FLM	10 Ω 1W	6290		金属被膜抵抗
ST300	V4040500	SCR. TERM	M3	6290		スクリューターミナル
ST401	V4040500	SCR. TERM	M3	6290		スクリューターミナル
ST402	WK497300	SCR. TERM	M3 3P	6290		スクリューターミナル
ST403	V4040500	SCR. TERM	M3	6290		スクリューターミナル
U4001	V8210200	L. DTCT	GP1UD271XK	6290		リモコン受光ユニット
XL401	V7556000	RSNR. CRY5	4. 332MHz HC-49U	6290	G	水晶振動子
XL402	WF997400	RSNR. CE	20MHz	6290		セラミック振動子
	WH567400	P. C. B.	OPERATION		J	P C B オペレーション
	WH567300	P. C. B.	OPERATION		UC	P C B オペレーション
	WH567500	P. C. B.	OPERATION		RTKABGEL	P C B オペレーション
CB801	VB858500	CN. BS. PIN	6P			ベースピン
CB802	VQ047200	CN. BS. PIN	9P			F F Cコネクター
CB803	VM929900	CN. BS. PIN	15P			F P Cコネクター
CB804	V7825400	CN	4P TE TUC SERIES			コネクタープラグ
CB805	VB389900	CN. BS. PIN	3P			ベースピン
CB806	VB390500	CN. BS. PIN	9P			コネクターベースポスト
CB807	VB390100	CN. BS. PIN	5P			ベースピン
CB809	VB389800	CN. BS. PIN	2P			ベースピン
CB810	V7827100	SOCKET	4P TE TUC SERIES			コネクターソケット
CB811	WG668100	CN. USB	USB 4P SE			USBコネクター
CB812	VB858600	CN. BS. PIN	7P			ベースピン
CB813	V7827200	SOCKET	5P TE TUC SERIES			コネクターソケット
CB814	VB858500	CN. BS. PIN	6P			ベースピン
CB815	V7825500	CN	5P TE TUC SERIES			コネクタープラグ
C8001	US135100	C. CE. CHP	0. 1uF 16V			チップセラコン
C8002	US063100	C. CE. CHP	1000pF 50V B			チップセラコン
C8004	US063100	C. CE. CHP	1000pF 50V B			チップセラコン
C8005-8007	US061220	C. CE. CHP	22pF 50V B			チップセラコン
C8008	US135100	C. CE. CHP	0. 1uF 16V			チップセラコン
C8009-8012	US061220	C. CE. CHP	22pF 50V B			チップセラコン
C8013-8014	US063100	C. CE. CHP	1000pF 50V B			チップセラコン
C8015	US135100	C. CE. CHP	0. 1uF 16V			チップセラコン
C8016-8017	UM397220	C. EL	22uF 25V			ケミコン
C8018	US135100	C. CE. CHP	0. 1uF 16V			チップセラコン
C8020	WJ604300	C. MYLAR	3300pF 50V			マイラーコン
C8021	UR237100	C. EL	10uF 16V			ケミコン
C8022	US062100	C. CE. CHP	100pF 50V B			チップセラコン
C8024	US064100	C. CE. CHP	0. 01uF 50V B			チップセラコン
C8025	WJ604300	C. MYLAR	3300pF 50V			マイラーコン
C8026-8027	UR237100	C. EL	10uF 16V			ケミコン
C8030	US061330	C. CE. CHP	33pF 50V B			チップセラコン
C8031	US063100	C. CE. CHP	1000pF 50V B			チップセラコン
C8032	US135100	C. CE. CHP	0. 1uF 16V			チップセラコン
C8033	UR237470	C. EL	47uF 16V			ケミコン
C8034-8035	US062470	C. CE. CHP	470pF 50V B			チップセラコン
C8036-8037	US062100	C. CE. CHP	100pF 50V B			チップセラコン
C8038	UR237470	C. EL	47uF 16V			ケミコン
C8039	US135100	C. CE. CHP	0. 1uF 16V		J	チップセラコン

* New Parts * 新規部品

P.C.B. OPERATION and P.C.B. MAIN

Ref No.	Part No.	Description	Remarks	Markets	部 品 名	ランク
C8040-8042	US062100	C. CE. CHP	100pF 50V B		チップセラコン	01
C8043	US135100	C. CE. CHP	0. 1uF 16V		チップセラコン	01
C8044	US063100	C. CE. CHP	1000pF 50V B		チップセラコン	01
C8045-8046	US135100	C. CE. CHP	0. 1uF 16V		チップセラコン	01
C8047	UM397220	C. EL	22uF 25V		ケミコン	01
C8048-8049	UR237100	C. EL	10uF 16V		ケミコン	
C8050	US063100	C. CE. CHP	1000pF 50V B		チップセラコン	01
C8051	US062100	C. CE. CHP	100pF 50V B		チップセラコン	01
C8052	US135100	C. CE. CHP	0. 1uF 16V		チップセラコン	01
C8053	US063100	C. CE. CHP	1000pF 50V B		チップセラコン	01
C8054-8055	US061100	C. CE. CHP	10pF 50V B		チップセラコン	01
C8056	US135100	C. CE. CHP	0. 1uF 16V		チップセラコン	01
C8057	UR237100	C. EL	10uF 16V		ケミコン	
C8058-8059	WB553000	C. EL	1000uF 16V		ケミコン VK	
C8060-8062	US063100	C. CE. CHP	1000pF 50V B		チップセラコン	01
C8063-8064	US135100	C. CE. CHP	0. 1uF 16V		チップセラコン	01
D8001	WG760400	LED	SELK6E10C BLUE		L E D	04
D8004-8008	VT332900	DIODE	1SS355		ダイオード	01
D8009	VU992600	DIODE. ZENR	MA8051-M 5. 1V		ツェナーダイオード	01
D8010	VT332900	DIODE	1SS355		ダイオード	01
D8011	VV307700	DIODE	1N4002S		ダイオード	01
D8013	VV307700	DIODE	1N4002S		ダイオード	01
IC801	X7378A00	IC	NJM4565M (TE1)		アンプ I C	01
IC802	X2080A00	IC	SN74AHCT1G32DCKR		ロジック I C	01
IC805	XS377A00	IC	BA15218F OP AMP		アンプ I C	01
JK801	V2589500	CN. DIN	1P		ミニ D I Nコネクタ	02
JK802	V9408200	JACK. PHONE	MSJ-064-05B GR		ホーンジャック	03
JK803	WE260000	JACK. MNI	LGY6501-0900FC		モノラルミニジャック	02
PJ801	V6222800	JACK. PIN	3P		ピンジャック	04
PN801-802	V9637500	PIN	L=70 #18		スタイルピン	
Q8001	WC529400	TR	KTC3875S Y GR RTK		トランジスタ	01
Q8002-8003	VZ725900	TR	2SD1938F S, T		トランジスタ	01
R8026	HF355100	R. CAR	100 Ω 1/2W		カーボン抵抗	
R8030	HF355100	R. CAR	100 Ω 1/2W		カーボン抵抗	
R8044-8045	HL005220	R. MTL. OXD	220 Ω 1/2W		酸化金属被膜抵抗	
SW801-802	V4757100	SW. TACT	EVQ11A		タクトSW	01
SW803	V9281200	SW. RT. ENC	EVEGC1F2512B		ロータリーエンコーダ	02
SW805	V4757100	SW. TACT	EVQ11A		タクトSW	01
SW806	V6578000	SW. RT. ENC	RB161PVB20FHINA		ロータリーエンコーダ	04
SW807	V9281200	SW. RT. ENC	EVEGC1F2512B		ロータリーエンコーダ	02
SW808	V9661700	SW. PUSH	SY16-32-4 (U99S2) /T		プッシュSW	03
U8001	WB547900	CN. PHOTO. R	1P GP1FA513RZOF		光ファイバー受信器	03
*	WP410200	P. C. B.	MAIN	J	P C B M A I N	
*	WP410300	P. C. B.	MAIN	UC	P C B M A I N	
*	WP410400	P. C. B.	MAIN	RTA	P C B M A I N	
*	WP410500	P. C. B.	MAIN	KBGEL	P C B M A I N	
CB252	WB127100	CN. BS. PIN	3P		ベース付ポスト	
CB253	LB932080	CN	8P		ベースポスト	01
C250-256	WK041800	C. EL	10uF 16V		ケミコン	01
C257	UR297220	C. EL	22uF 100V	JUC	ケミコン	
C257	UR297470	C. EL	47uF 100V	RTKABGEL	ケミコン	01
C258	UR297220	C. EL	22uF 100V		ケミコン	

* New Parts * 新規部品

P.C.B. MAIN

Ref No.	Part No.	Description	Remarks	Markets	部 品 名	ランク	
C259	WE100400	C. PP	47pF	630V		PPコン	
C260	WE100900	C. PP	220pF	630V		PPコン	02
C261	UR297220	C. EL	22uF	100V		ケミコン	
C262	WE100400	C. PP	47pF	630V		PPコン	
C263	WE100900	C. PP	220pF	630V		PPコン	02
C264	UR297220	C. EL	22uF	100V		ケミコン	
C265	WE100400	C. PP	47pF	630V		PPコン	
C266-267	WE100900	C. PP	220pF	630V		PPコン	02
C268	WE100400	C. PP	47pF	630V		PPコン	
C269	WE100900	C. PP	220pF	630V		PPコン	02
C271	WE100400	C. PP	47pF	630V		PPコン	
C272	WE100900	C. PP	220pF	630V		PPコン	02
C274	WE100400	C. PP	47pF	630V		PPコン	
C275	WE100900	C. PP	220pF	630V		PPコン	02
C277	WE100400	C. PP	47pF	630V		PPコン	
C278	WE100900	C. PP	220pF	630V		PPコン	02
C280-286	UR068100	C. EL	100uF	50V		ケミコン	01
C287-293	WE100100	C. PP	15pF	630V		PPコン	
C294-300	WE102500	C. PP	4700pF	100V		PPコン	01
C303	UR267470	C. EL	47uF	50V		ケミコン	01
C304-305	UR297220	C. EL	22uF	100V		ケミコン	
C306	WP420700	C. PP	100pF	100V		PPコン	
△ C307	UR397100	C. EL	10uF	100V		ケミコン	03
C308-309	WP420700	C. PP	100pF	100V		PPコン	
△ C310	UR397100	C. EL	10uF	100V		ケミコン	03
C311-312	WP420700	C. PP	100pF	100V		PPコン	
△ C313	UR397100	C. EL	10uF	100V		ケミコン	03
C314-315	WP420700	C. PP	100pF	100V		PPコン	
△ C316	UR397100	C. EL	10uF	100V		ケミコン	03
C317-318	WP420700	C. PP	100pF	100V		PPコン	
△ C319	UR397100	C. EL	10uF	100V		ケミコン	03
C320-321	WP420700	C. PP	100pF	100V		PPコン	
△ C322	UR397100	C. EL	10uF	100V		ケミコン	03
C323-324	WP420700	C. PP	100pF	100V		PPコン	
△ C325	UR397100	C. EL	10uF	100V		ケミコン	03
C326	WP420700	C. PP	100pF	100V		PPコン	
* C327-333	WP421000	C. PP	0.047uF	100V		PPコン	
* C334-340	WP476300	C. MYLAR	0.39uF	50V		マイラーコン	
C341	UR296470	C. EL	4.7uF	100V		ケミコン	01
C342	UR218220	C. EL	220uF	6.3V		ケミコン	
C343	UR067470	C. EL	47uF	50V		ケミコン	01
C346-347	UR397100	C. EL	10uF	100V		ケミコン	03
C350-351	UR397100	C. EL	10uF	100V		ケミコン	03
C354-355	UR397100	C. EL	10uF	100V		ケミコン	03
C359	WJ788600	C. EL	12000uF	71V		ケミコン	08
* C360	WP421000	C. PP	0.047uF	100V		PPコン	
C363	WJ788600	C. EL	12000uF	71V		ケミコン	08
* C364	WP421000	C. PP	0.047uF	100V		PPコン	
C368	WJ605400	C. MYLAR	0.022uF	50V J		マイラーコン	01
C369	WJ605000	C. MYLAR	0.01uF	50V J		マイラーコン	01
C371-374	WJ605000	C. MYLAR	0.01uF	50V J		マイラーコン	01
C376	WJ605400	C. MYLAR	0.022uF	50V J		マイラーコン	01
C377	WJ605000	C. MYLAR	0.01uF	50V J		マイラーコン	01
C378	WJ605400	C. MYLAR	0.022uF	50V J		マイラーコン	01
C379	UR067470	C. EL	47uF	50V		ケミコン	01

* New Parts * 新規部品

P.C.B. MAIN

Ref No.	Part No.	Description	Remarks	Markets	部 品 名	ランク
C382	UR296470	C. EL	4. 7uF 100V		ケミコン	01
C383-384	WJ605400	C. MYLAR	0. 022uF 50V J		マイラーコン	01
C385-386	WJ605000	C. MYLAR	0. 01uF 50V J		マイラーコン	01
C389-393	WJ605000	C. MYLAR	0. 01uF 50V J		マイラーコン	01
C394-395	WJ605400	C. MYLAR	0. 022uF 50V J		マイラーコン	01
C396	WJ605000	C. MYLAR	0. 01uF 50V J		マイラーコン	01
C397	WJ605400	C. MYLAR	0. 022uF 50V J		マイラーコン	01
C398	WJ605400	C. MYLAR	0. 022uF 50V J	UCRTKABGEL	マイラーコン	01
C399	WJ605000	C. MYLAR	0. 01uF 50V J	UCRTKABGEL	マイラーコン	01
C400	WJ605000	C. MYLAR	0. 01uF 50V J	UCRTKABGEL	マイラーコン	01
C401	WJ605000	C. MYLAR	0. 01uF 50V J		マイラーコン	01
C402	WJ605400	C. MYLAR	0. 022uF 50V J		マイラーコン	01
C403	WJ605000	C. MYLAR	0. 01uF 50V J	UCRTKABGEL	マイラーコン	01
C404	WJ605400	C. MYLAR	0. 022uF 50V J	UCRTKABGEL	マイラーコン	01
D250-251	VH282500	DIODE	RLS245		ダイオード	01
D252-258	VT332900	DIODE	1SS355		ダイオード	01
D259-262	VH282500	DIODE	RLS245		ダイオード	01
D264	VU992600	DIODE. ZENR	MA8051-M 5. 1V		ツェナーダイオード	01
D265-278	VT332900	DIODE	1SS355		ダイオード	01
△ D279-285	VG437500	DIODE. ZENR	MTZJ5. 1C 5. 1V		ツェナーダイオード	01
D286-299	VH282500	DIODE	RLS245		ダイオード	01
D300	VU992000	DIODE. ZENR	MA8047 4. 7V		ツェナーダイオード	01
△ D301	WD890200	DIODE. BRG	D15XBN20 30A 200V		ダイオードブリッジ	06
D302	VM976300	DIODE. ZENR	HZS242TD 24V		ツェナーダイオード	01
D304	VM976300	DIODE. ZENR	HZS242TD 24V	UCRTKABGEL	ツェナーダイオード	01
D305-307	VM976300	DIODE. ZENR	HZS242TD 24V		ツェナーダイオード	01
D309	VU999800	DIODE. ZENR	MA8300-L 29V		ツェナーダイオード	01
D313	VM976300	DIODE. ZENR	HZS242TD 24V	UCRTKABGEL	ツェナーダイオード	01
D314	VM976300	DIODE. ZENR	HZS242TD 24V		ツェナーダイオード	01
G250	V5995800	PLATE. GND			アースプレート	
PN250-253	V9637500	PIN	L=70 #18		スタイルピン	
Q250-256	WH199400	IC	HN4C06J		トランジスタアレイ	01
Q257-263	WH372100	TR	KTA1517S GR TP		トランジスタ	01
Q264	WC139600	TR	KTC3911S GR BL		トランジスタ	01
Q265	WH372100	TR	KTA1517S GR TP		トランジスタ	01
△ Q266	VC938500	TR	2SC3852		トランジスタ	02
△ Q267	VC614000	TR	2SB1274 Q, R, S		トランジスタ	02
Q268	WH372100	TR	KTA1517S GR TP		トランジスタ	01
Q269-277	WC139600	TR	KTC3911S GR BL		トランジスタ	01
Q278-284	V3966800	TR	2SA949 O, Y		トランジスタ	02
△ Q286-292	VR325600	TR	2SC2229 O, Y		トランジスタ	01
△ Q293-299	VK432900	TR	2SD1915F S, T		トランジスタ	01
△ Q307-313	WD281200	TR. PAIR	A2151/C6011 O, P, Y		ペアトランジスタ	07
Q314-320	WC139600	TR	KTC3911S GR BL		トランジスタ	01
Q321	WH372100	TR	KTA1517S GR TP		トランジスタ	01
△ Q322	VC614000	TR	2SB1274 Q, R, S		トランジスタ	02
Q339	VR043100	FET	2SK208 Y		チップFET	01
Q340-346	WC139600	TR	KTC3911S GR BL		トランジスタ	01
△ Q360	WG408900	TR	2SC5291 S, T		トランジスタ	03
△ Q361	WG408800	TR	2SA2168 S, T		トランジスタ	03
△ Q362	WG408900	TR	2SC5291 S, T		トランジスタ	03
△ Q363	WG408800	TR	2SA2168 S, T		トランジスタ	03
△ Q364	WG408900	TR	2SC5291 S, T		トランジスタ	03
△ Q365	WG408800	TR	2SA2168 S, T		トランジスタ	03
△ Q366	WG408900	TR	2SC5291 S, T		トランジスタ	03

* New Parts * 新規部品

P.C.B. MAIN

Ref No.	Part No.	Description	Remarks	Markets	部 品 名	ランク
△ Q367	WG408800	TR 2SA2168 S, T			トランジスタ	03
△ Q368	WG408900	TR 2SC5291 S, T			トランジスタ	03
△ Q369	WG408800	TR 2SA2168 S, T			トランジスタ	03
△ Q370	WG408900	TR 2SC5291 S, T			トランジスタ	03
△ Q371	WG408800	TR 2SA2168 S, T			トランジスタ	03
△ Q372	WG408900	TR 2SC5291 S, T			トランジスタ	03
△ Q373	WG408800	TR 2SA2168 S, T			トランジスタ	03
R271-272	HV757270	R. CAR. FP 27K Ω 1/4W			不燃化カーボン抵抗	01
△ R307	V8071400	R. MTL. FLM 560 Ω 1W			金属被膜抵抗	
△ R311	V8071400	R. MTL. FLM 560 Ω 1W			金属被膜抵抗	
△ R313	V8071400	R. MTL. FLM 560 Ω 1W			金属被膜抵抗	
△ R315	V8071400	R. MTL. FLM 560 Ω 1W		UCRTKABGEL	金属被膜抵抗	
△ R317	V8071400	R. MTL. FLM 560 Ω 1W			金属被膜抵抗	
△ R341	V8071400	R. MTL. FLM 560 Ω 1W			金属被膜抵抗	
R355-358	HV757270	R. CAR. FP 27K Ω 1/4W			不燃化カーボン抵抗	01
R366	HV757100	R. CAR. FP 10K Ω 1/4W			不燃化カーボン抵抗	01
R367	HV757160	R. CAR. FP 16K Ω 1/4W			不燃化カーボン抵抗	01
R368	HV757200	R. CAR. FP 20K Ω 1/4W			不燃化カーボン抵抗	01
R379	V8070900	R. MTL. FLM 100 Ω 1W			金属被膜抵抗	01
R381	V8070900	R. MTL. FLM 100 Ω 1W			金属被膜抵抗	01
R383	V8070900	R. MTL. FLM 100 Ω 1W			金属被膜抵抗	01
R385	V8070900	R. MTL. FLM 100 Ω 1W			金属被膜抵抗	01
R387	V8070900	R. MTL. FLM 100 Ω 1W			金属被膜抵抗	01
R389	V8070900	R. MTL. FLM 100 Ω 1W			金属被膜抵抗	01
R391	V8070900	R. MTL. FLM 100 Ω 1W			金属被膜抵抗	01
△ R401	HV754100	R. CAR. FP 10 Ω 1/4W			不燃化カーボン抵抗	01
△ R403	HV754100	R. CAR. FP 10 Ω 1/4W			不燃化カーボン抵抗	01
R404	V3946100	R. MTL. OXD 2.7K Ω 1/2W			酸化金属被膜抵抗	01
R405	V3945100	R. MTL. OXD 390 Ω 1/2W			酸化金属被膜抵抗	
R406	V3945500	R. MTL. OXD 820 Ω 1/2W			酸化金属被膜抵抗	
△ R407	HV755120	R. CAR. FP 120 Ω 1/4W			不燃化カーボン抵抗	01
R408	V3946100	R. MTL. OXD 2.7K Ω 1/2W			酸化金属被膜抵抗	01
R409	V3945100	R. MTL. OXD 390 Ω 1/2W			酸化金属被膜抵抗	
R410	V3945500	R. MTL. OXD 820 Ω 1/2W			酸化金属被膜抵抗	
△ R411	HV755120	R. CAR. FP 120 Ω 1/4W			不燃化カーボン抵抗	01
R412	V3946100	R. MTL. OXD 2.7K Ω 1/2W			酸化金属被膜抵抗	01
R413	V3945100	R. MTL. OXD 390 Ω 1/2W			酸化金属被膜抵抗	
R414	V3945500	R. MTL. OXD 820 Ω 1/2W			酸化金属被膜抵抗	
△ R415	HV755120	R. CAR. FP 120 Ω 1/4W			不燃化カーボン抵抗	01
R416	V3946100	R. MTL. OXD 2.7K Ω 1/2W			酸化金属被膜抵抗	01
R417	V3945100	R. MTL. OXD 390 Ω 1/2W			酸化金属被膜抵抗	
R418	V3945500	R. MTL. OXD 820 Ω 1/2W			酸化金属被膜抵抗	
△ R419	HV755120	R. CAR. FP 120 Ω 1/4W			不燃化カーボン抵抗	01
R420	V3946100	R. MTL. OXD 2.7K Ω 1/2W			酸化金属被膜抵抗	01
R421	V3945100	R. MTL. OXD 390 Ω 1/2W			酸化金属被膜抵抗	
R422	V3945500	R. MTL. OXD 820 Ω 1/2W			酸化金属被膜抵抗	
△ R423	HV755120	R. CAR. FP 120 Ω 1/4W			不燃化カーボン抵抗	01
R424	V3946100	R. MTL. OXD 2.7K Ω 1/2W			酸化金属被膜抵抗	01
R425	V3945100	R. MTL. OXD 390 Ω 1/2W			酸化金属被膜抵抗	
R426	V3945500	R. MTL. OXD 820 Ω 1/2W			酸化金属被膜抵抗	
△ R427	HV755120	R. CAR. FP 120 Ω 1/4W			不燃化カーボン抵抗	01
R428	V3946100	R. MTL. OXD 2.7K Ω 1/2W			酸化金属被膜抵抗	01
R429	V3945100	R. MTL. OXD 390 Ω 1/2W			酸化金属被膜抵抗	
R430	V3945500	R. MTL. OXD 820 Ω 1/2W			酸化金属被膜抵抗	
△ R431	HV755120	R. CAR. FP 120 Ω 1/4W			不燃化カーボン抵抗	01

* New Parts * 新規部品

RX-V1900/HTR-6290/
DSP-AX1900

P.C.B. MAIN and P.C.B. POWER

Ref No.	Part No.	Description	Remarks	Markets	部 品 名	ランク	
	R432-438	V3945600 R. MTL. OXD	1K Ω 1/2W			酸化金属被膜抵抗	
△	R439-445	HV753470 R. CAR. FP	4.7 Ω 1/4W			不燃化カーボン抵抗	01
△	R446-452	HV755220 R. CAR. FP	220 Ω 1/4W			不燃化カーボン抵抗	01
△	R453-466	HV753470 R. CAR. FP	4.7 Ω 1/4W			不燃化カーボン抵抗	01
△	R467-473	WG471300 R. WW	0.22 Ω x2 5W	RF-5EGKR22		セメント抵抗	01
△	R496-502	V8070200 R. MTL. FLM	4.7 Ω 1W			金属被膜抵抗	
△	R519-525	HV754100 R. CAR. FP	10 Ω 1/4W			不燃化カーボン抵抗	01
△	R550	V8070000 R. MTL. FLM	1 Ω 1W			金属被膜抵抗	01
△	R552	V8070000 R. MTL. FLM	1 Ω 1W			金属被膜抵抗	01
△	R554	V8070000 R. MTL. FLM	1 Ω 1W			金属被膜抵抗	01
△	R571-573	HV753470 R. CAR. FP	4.7 Ω 1/4W			不燃化カーボン抵抗	01
△	R575	HV755100 R. CAR. FP	100 Ω 1/4W			不燃化カーボン抵抗	01
△	R581	HV753470 R. CAR. FP	4.7 Ω 1/4W			不燃化カーボン抵抗	01
△	R583	HV753470 R. CAR. FP	4.7 Ω 1/4W			不燃化カーボン抵抗	01
△	R585-586	HV753470 R. CAR. FP	4.7 Ω 1/4W			不燃化カーボン抵抗	01
△	R593	HV753470 R. CAR. FP	4.7 Ω 1/4W			不燃化カーボン抵抗	01
△	R595	HV753470 R. CAR. FP	4.7 Ω 1/4W		UCRTKABGEL	不燃化カーボン抵抗	01
△	R596	HV753470 R. CAR. FP	4.7 Ω 1/4W		UCRTKABGEL	不燃化カーボン抵抗	01
△	R597	HV755100 R. CAR. FP	100 Ω 1/4W			不燃化カーボン抵抗	01
	RY250	WE648700 RELAY	DC DH24D2-0-Q		UCRTKABGEL	リレー 24V	06
	RY251	WE648700 RELAY	DC DH24D2-0-Q			リレー 24V	06
	RY252-253	V6322600 RELAY	DC DH24D2-0T (M)-SL			リレー 24V	04
	RY254	WM959000 RELAY	DC24V G5PA-28-MC		UCRTKABGEL	リレー 24V	
	RY255-257	V6322600 RELAY	DC DH24D2-0T (M)-SL			リレー 24V	04
	TE250	WD756900 TERM. SP	LTS3210-1004FM		JUCRTA	スピーカーターミナル	04
	TE250	WK434500 TERM. SP	2P LTS3210-1010FM		KBGEL	スピーカーターミナル	
	TE251	WD477700 TERM. SP	LTS0810-1019FM		JUCRTA	スピーカーターミナル	06
	TE251	WK466600 TERM. SP	8P LTS0810-1024FM		KBGEL	スピーカーターミナル	
	TE252	WD477700 TERM. SP	LTS0810-1019FM		JUCRTA	スピーカーターミナル	06
	TE252	WK466600 TERM. SP	8P LTS0810-1024FM		KBGEL	スピーカーターミナル	
	TE253	WD039300 TERM. SP	4P LQR2411-0001FM		UCRTA	スピーカーターミナル	04
	TE253	WD039400 TERM. SP	4P LQR2411-0003FM		KBGEL	スピーカーターミナル	
		VT669300 SCR. PW. HD	3x8-8 MFC2			PWヘッドBタイトネジ	01
*		WP416600 P. C. B.	POWER		J	PCB POWER	
*		WP416700 P. C. B.	POWER		UC	PCB POWER	
*		WP416800 P. C. B.	POWER		R	PCB POWER	
*		WP416900 P. C. B.	POWER		T	PCB POWER	
*		WP417000 P. C. B.	POWER		K	PCB POWER	
*		WP417100 P. C. B.	POWER		A	PCB POWER	
*		WP417200 P. C. B.	POWER		B	PCB POWER	
*		WP417300 P. C. B.	POWER		GE	PCB POWER	
*		WP417400 P. C. B.	POWER		L	PCB POWER	
	CB1	WN103000 CLIP. FUSE	TP00351-31		UC	ヒューズクリップ	01
	CB1-2	WN077700 CLIP. FUSE	CLIP PFC5000-0202F		TGE	ヒューズクリップ	
	CB2	WN077700 CLIP. FUSE	CLIP PFC5000-0202F		TGE	ヒューズクリップ	
	CB3	WN103000 CLIP. FUSE	TP00351-31		JUCRL	ヒューズクリップ	01
	CB3	WN077700 CLIP. FUSE	CLIP PFC5000-0202F		TKABGE	ヒューズクリップ	
	CB4	WN103000 CLIP. FUSE	TP00351-31		JUCRL	ヒューズクリップ	01
	CB4	WN077700 CLIP. FUSE	CLIP PFC5000-0202F		TKABGE	ヒューズクリップ	
	CB6	VG879900 CN. BS. PIN	2P			ベースピン	01
	CB7	V9377900 CN. BS. PIN	4P		RL	ベース付ポスト	
	CB8	V9377800 CN. BS. PIN	3P		RL	ベース付ポスト	

* New Parts * 新規部品

RX-V1900/HTR-6290/DSP-AX1900

P.C.B. POWER

Ref No.	Part No.	Description	Remarks	Markets	部 品 名	ランク	
CB9	WN077700	CLIP. FUSE	CLIP PFC5000-0202F		RL	ヒューズクリップ	
CB10	WN077700	CLIP. FUSE	CLIP PFC5000-0202F		RL	ヒューズクリップ	
CB11	LB919110	CN. BS. PIN	11P SE			ベースツキポスト	01
CB12	VB858400	CN. BS. PIN	5P			ベースピン	01
CB15	LB918060	CN. BS. PIN	6P			ベース付ポスト	01
CB16	LB918100	CN. BS. PIN	10P			ベース付ポスト	02
CB17	LB918060	CN. BS. PIN	6P			ベース付ポスト	01
CB18	VN394900	CN. BS. PIN	14P			FFCコネクタ	01
CB19	VB389900	CN. BS. PIN	3P			ベースピン	01
CB20	LB918040	CN. BS. PIN	4P			ベース付ポスト	01
CB21	VF283100	CN. BS. PIN	13P			コネクタベースポスト	01
CB23	VB390000	CN. BS. PIN	4P			ベースピン	01
C1	UU266220	C. EL	2. 2uF 50V			ケミコン FW	01
C2	UR266220	C. EL	2. 2uF 50V			ケミコン	
C3	WJ605000	C. MYLAR	0. 01uF 50V J			マイラーコン	01
△ C4	WB687100	C. POL. MTL	0. 047uF 400V	JUC		メタライズドポリコン	01
△ C4	WD054200	C. POL. MTL	0. 047uF 630V	RL		メタライズドポリコン	02
△ C4	WC041600	C. POL. MTL	0. 022uF 630V	TKABGE		メタライズドポリコン	01
C5	UU266100	C. EL	1uF 50V			ケミコン	01
* C6	WJ604500	C. MYLAR	4700pF 50V			マイラーコン	
C7	WB696300	C. POL. MTL	0. 1uF 400V	JUC		メタライズドポリコン	
C7	WF081500	C. PP	0. 047uF 630V J	RTKABGEL		PPコン	
△ C8	V6185300	C. CE. SAFTY	0. 01uF 275V			規格認定コンデンサ	01
C9	WE102900	C. PP	0. 01uF 100V			PPコン	
C10	UU249330	C. EL	3300uF 25V			ケミコン FW	04
C10	UU249330	C. EL	3300uF 25V	JUCTKABGE		ケミコン FW	04
C10	WD047300	C. EL	3300uF 50V	RL		ケミコン KMQ	
C11-12	WN165300	C. PP	0. 01uF 100V			PPコン	01
C13-14	VR324900	C. MYLAR	0. 1uF 100V			マイラーコン	01
C15	WN165300	C. PP	0. 01uF 100V			PPコン	01
△ C17	URO49680	C. EL	6800uF 25V			ケミコン	
C18	URO3A150	C. EL	15000uF 16V			ケミコン	05
C19	URO3A100	C. EL	10000uF 16V			ケミコン	
△ C20-21	URO49680	C. EL	6800uF 25V			ケミコン	
△ C22-23	WH776000	C. EL	1000uF 25V			ケミコン	01
C24-25	WJ611400	C. MYLAR	0. 1uF 100V J			マイラーコン	01
C26-27	V7720300	C. CE. M. CHP	1uF 25V			チップ積層セラコン	
C28-29	US064100	C. CE. CHP	0. 01uF 50V B			チップセラコン	01
C31	WH772100	C. EL	1000uF 10V			ケミコン	04
C33	WH772100	C. EL	1000uF 10V			ケミコン	04
C34-35	V7720300	C. CE. M. CHP	1uF 25V			チップ積層セラコン	
C36-37	US065100	C. CE. CHP	0. 1uF 50V B			チップセラコン	01
C40-41	WN165500	C. PP	0. 022uF 100V			PPコン	01
C42	VR324900	C. MYLAR	0. 1uF 100V			マイラーコン	01
C43	WJ611400	C. MYLAR	0. 1uF 100V J			マイラーコン	01
C44	US035100	C. CE. CHP	0. 1uF 16V B			チップセラコン	01
C45	UR266100	C. EL	1uF 50V	JUCRTKABGE		ケミコン	01
C45	V7887800	C. EL	1uF 50V	L		ケミコン	
C46	UR266100	C. EL	1uF 50V	JUCRTKABGE		ケミコン	01
C46	V7887800	C. EL	1uF 50V	L		ケミコン	
C47	UU266100	C. EL	1uF 50V			ケミコン	01
C48	UR267100	C. EL	10uF 50V			ケミコン	
C49	UU266100	C. EL	1uF 50V	JRTKABGEL		ケミコン	01
C50	URO3A150	C. EL	15000uF 16V			ケミコン	05
C51	UR266220	C. EL	2. 2uF 50V			ケミコン	

* New Parts * 新規部品

P.C.B. POWER

	Ref No.	Part No.	Description	Remarks	Markets	部 品 名	ランク
*	C51	WJ335500	C. EL 2. 2uF 50V		L	ケミコン	
	C52	UR266220	C. EL 2. 2uF 50V		JUCRTKABGE	ケミコン	
*	C52	WJ335500	C. EL 2. 2uF 50V		L	ケミコン	
	C53	WH771300	C. EL 100uF 10V		JRTKABGEL	ケミコン	01
	C54	UR049680	C. EL 6800uF 25V			ケミコン	
	C55	UR266100	C. EL 1uF 50V			ケミコン	01
	C56-58	WH771300	C. EL 100uF 10V			ケミコン	01
	C59-60	UR049680	C. EL 6800uF 25V			ケミコン	
	C61	UR266100	C. EL 1uF 50V		JUCRTKABGE	ケミコン	01
	C61	V7887800	C. EL 1uF 50V		L	ケミコン	
	C62	UR266100	C. EL 1uF 50V		JUCRTKABGE	ケミコン	01
	C62	V7887800	C. EL 1uF 50V		L	ケミコン	
	C63	UR238100	C. EL 100uF 16V			ケミコン	
	C64	WH771300	C. EL 100uF 10V			ケミコン	01
	C65-67	US065100	C. CE. CHP 0. 1uF 50V B			チップセラコン	01
	C68-70	UR267100	C. EL 10uF 50V			ケミコン	
	C72	UR238100	C. EL 100uF 16V			ケミコン	
	C73-74	WK041800	C. EL 10uF 16V			ケミコン	01
	C75	WJ605000	C. MYLAR 0. 01uF 50V J			マイラーコン	01
	C76	WH772100	C. EL 1000uF 10V			ケミコン	04
	C78	WH772100	C. EL 1000uF 10V			ケミコン	04
	C82-83	V7720300	C. CE. M. CHP 1uF 25V			チップ積層セラコン	
	C84	UR238100	C. EL 100uF 16V			ケミコン	
	C85	UU238220	C. EL 220uF 16V			ケミコン FW	01
	C91-92	US065100	C. CE. CHP 0. 1uF 50V B			チップセラコン	01
	C93-94	US063680	C. CE. CHP 6800pF 50V B			チップセラコン	01
	C95	UR068220	C. EL 220uF 50V		JUC	ケミコン	01
	C95	UR068100	C. EL 100uF 50V		RTKABGEL	ケミコン	01
	D1-4	VT332900	DIODE 1SS355			ダイオード	01
	D5	VU990500	DIODE. ZENR MA8030-L 2. 9V			ツェナーダイオード	01
	D6	VG438300	DIODE. ZENR MTZJ6. 8B 6. 8V			ツェナーダイオード	01
	D7	VG439500	DIODE. ZENR MTZJ10B 10V			ツェナーダイオード	01
	D8	VD631600	DIODE 1SS133, 176			ダイオード	01
	D9	VU994200	DIODE. ZENR MA8075-M 7. 5V			ツェナーダイオード	01
△	D10-11	WH471700	DIODE. BRG DB105 1A 600V			ダイオードブリッジ	02
*	△ D12-13	WH487100	DIODE. BRG KRS440M-B-C-J80			ダイオードブリッジ	
△	D14	WH487300	DIODE. BRG RS203M 2. 0A 200V			ダイオードブリッジ	02
	D17-18	V6267600	DIODE RB051L-40			ダイオード	01
△	D19-20	WH487300	DIODE. BRG RS203M 2. 0A 200V			ダイオードブリッジ	02
	D21	VT332900	DIODE 1SS355			ダイオード	01
	D29	VU991700	DIODE. ZENR MA8043-L 4. 1V			ツェナーダイオード	01
	D30	VT332900	DIODE 1SS355			ダイオード	01
	D36	VU993400	DIODE. ZENR MA8062-M 6. 2V			ツェナーダイオード	01
	D37-38	VU996600	DIODE. ZENR MA8130-M 13V			ツェナーダイオード	01
	D40-41	V6267600	DIODE RB051L-40			ダイオード	01
	D43	VU999100	DIODE. ZENR MA8240-M 24V		RL	ツェナーダイオード	01
*	△ F1	WQ211200	FUSE 10A 125V		J	ヒューズ	
△	F1	WG410800	FUSE 10A 125V		UCRL	ヒューズ	01
△	F1	WB760600	FUSE T6. 3A 250V		TKABGE	ヒューズ	01
△	F2	WG410800	FUSE 10A 125V		UC	ヒューズ	01
△	F2	VT942900	FUSE T2. 5A 250V		TGE	ヒューズ	01
△	F3	WB760600	FUSE T6. 3A 250V		RL	ヒューズ	01
△	IC1-2	WJ688100	PHOT. CPL EL816 (B)			フォトカプラ	01
△	IC3	iG001180	IC TC4013BP FF			ロジック I C	05
△	IC4	X8035A00	IC BA00JC5WT-V5		JRTKABGEL	電源 I C	04

* New Parts * 新規部品

P.C.B. POWER

	Ref No.	Part No.	Description	Remarks	Markets	部 品 名	ランク
△	IC5	X7974A00	IC	KIA7809API-U/P		電源 I C	02
△	IC6	X7973A00	IC	KIA79M05PI-U		電源 I C	02
△	IC7-8	X7851A00	IC	SI-8008HFE 0.8-24		電源 I C	07
△	IC9-12	X8035A00	IC	BA00JC5WT-V5		電源 I C	04
*	IC13-14	X0515B00	IC	LM61CIZ THERMAL		電源 I C	03
	PN1-6	V9637500	PIN	L=70 #18		スタイルピン	
	Q1	WC435100	TR. DGT	KRC104S-RTK		デジタルトランジスタ	01
	Q2-3	WC529400	TR	KTC3875S Y GR RTK		トランジスタ	01
	Q4	WC435100	TR. DGT	KRC104S-RTK		デジタルトランジスタ	01
△	Q6	WC741200	FET	2SK3850		F E T	03
	Q8	WC435100	TR. DGT	KRC104S-RTK		デジタルトランジスタ	01
	Q9	WC435000	TR. DGT	KRC102S-RTK		デジタルトランジスタ	01
△	Q10	VP872600	TR	2SA1708 S, T		トランジスタ	01
	Q11	WC434800	TR. DGT	KRA102S-RTK/P		デジタルトランジスタ	01
	Q12	WC529500	TR	KTA1504S Y GR RTK		トランジスタ	
	Q13	WC529400	TR	KTC3875S Y GR RTK		トランジスタ	01
△	Q14	VP872700	TR	2SC4488 S, T		トランジスタ	01
	Q15	VR043100	FET	2SK208 Y		チップ F E T	01
△	Q16	WF691400	TR	2SD2014		トランジスタ	03
	Q17-19	VR043100	FET	2SK208 Y		チップ F E T	01
△	Q20-21	WF691400	TR	2SD2014		トランジスタ	03
△	Q22	WF691300	TR	2SB1257		トランジスタ	03
	Q23-25	WC434900	TR. DGT	KRA104S-RTK		デジタルトランジスタ	01
	Q26	WC435100	TR. DGT	KRC104S-RTK		デジタルトランジスタ	01
	Q27-28	WC434900	TR. DGT	KRA104S-RTK		デジタルトランジスタ	01
	Q29	WC435100	TR. DGT	KRC104S-RTK	UCRTKABGEL	デジタルトランジスタ	01
	Q30	WC435100	TR. DGT	KRC104S-RTK		デジタルトランジスタ	01
	Q31	WC434900	TR. DGT	KRA104S-RTK	UCRTKABGEL	デジタルトランジスタ	01
	Q32	WC434900	TR. DGT	KRA104S-RTK		デジタルトランジスタ	01
	Q33	WC435100	TR. DGT	KRC104S-RTK		デジタルトランジスタ	01
	Q34	WC435100	TR. DGT	KRC104S-RTK	UCRTKABGEL	デジタルトランジスタ	01
	Q35	WC434900	TR. DGT	KRA104S-RTK		デジタルトランジスタ	01
	Q36	WC434900	TR. DGT	KRA104S-RTK	UCRTKABGEL	デジタルトランジスタ	01
	Q37-38	WC435100	TR. DGT	KRC104S-RTK		デジタルトランジスタ	01
	Q39-40	WC434900	TR. DGT	KRA104S-RTK		デジタルトランジスタ	01
	Q41	WC529500	TR	KTA1504S Y GR RTK		トランジスタ	
	Q42	WC529400	TR	KTC3875S Y GR RTK		トランジスタ	01
	Q43	WC529500	TR	KTA1504S Y GR RTK		トランジスタ	
	Q44	WC435000	TR. DGT	KRC102S-RTK		デジタルトランジスタ	01
	R18	V6730000	R. CAR.	2. 2M Ω 1/2W	UC	放電抵抗	01
	R22	V8071400	R. MTL. FLM	560 Ω 1W		金属被膜抵抗	
	R31	V8071400	R. MTL. FLM	560 Ω 1W	UCRTKABGEL	金属被膜抵抗	
△	R33	WH819500	R. FUSE	0. 47 Ω 1W		ヒューズ抵抗	01
△	R37	WH819500	R. FUSE	0. 47 Ω 1W		ヒューズ抵抗	01
	R43	V8070000	R. MTL. FLM	1 Ω 1W		金属被膜抵抗	01
△	R48-49	V8070000	R. MTL. FLM	1 Ω 1W		金属被膜抵抗	01
△	R55	HV753470	R. CAR. FP	4. 7 Ω 1/4W		不燃化カーボン抵抗	01
△	R57	HV755100	R. CAR. FP	100 Ω 1/4W		不燃化カーボン抵抗	01
△	R65-67	HV753470	R. CAR. FP	4. 7 Ω 1/4W		不燃化カーボン抵抗	01
△	R71-73	HV755100	R. CAR. FP	100 Ω 1/4W		不燃化カーボン抵抗	01
	R92	HV755100	R. CAR. FP	100 Ω 1/4W		不燃化カーボン抵抗	01
	R93	HV753100	R. CAR. FP	1 Ω 1/4W		不燃化カーボン抵抗	01
△	RY1	V9366900	RELAY	DLS9D1-0 (M) 0. 25W		リレー 9V T V - 8	05
	ST1-3	WG095100	SCR. TERM	M3		スクリューターミナル	01
	ST4-5	WA246200	SCR. TERM	3. 5		スクリューターミナル	

* New Parts * 新規部品

P.C.B. POWER and P.C.B. A-VIDEO

Ref No.	Part No.	Description	Remarks	Markets	部 品 名	ランク	
△ SW1	WB493700	VOLT. SELCT	R8140246		RL	電圧切替器	
△ T1	X7032A00	TRANS. PWR			J	電源トランス	05
△ T1	X7033A00	TRANS. PWR			UC	電源トランス	
△ T1	X7034A00	TRANS. PWR			RL	電源トランス	
△ T1	X7035A00	TRANS. PWR			TKABGE	電源トランス	
△ TE1	VU543100	OUTLET. AC	2P		JUC	A Cアウトレット	03
△ TE1	V5867400	OUTLET. AC	2P		RT	A Cアウトレット	03
△ TE1	VT915000	OUTLET. AC	1P		A	A Cアウトレット	06
△ TE1	VU543300	OUTLET. AC	1P		B	A Cアウトレット	05
△ TE1	VU543400	OUTLET. AC	2P		GEL	A Cアウトレット	05
△ TE2	WB782600	AC INLET	R-30190 (26)			A Cインレット 2 P	
	WE774300	SCR. BND. HD	3x8 MFZN2W3			バインドBタイトネジ	01
	WH565200	P. C. B.	A-VIDEO		J	P C B Aビデオ	23
*	WH565300	P. C. B.	A-VIDEO		UC	P C B Aビデオ	
*	WH565400	P. C. B.	A-VIDEO		RK	P C B Aビデオ	
*	WH565500	P. C. B.	A-VIDEO		TABGEL	P C B Aビデオ	
CB201-202	V8875300	CN. JE	13P SE			J Eコネクタープラグ	01
CB203	VQ044500	CN. BS. PIN	11P			F F Cコネクター	01
CB204	VP113500	CN. BS. PIN	10P			F F Cコネクター	01
G2001-2009	US064100	C. CE. CHP	0. 01uF 50V B		J	チップセラコン	01
G2010-2011	US135100	C. CE. CHP	0. 1uF 16V		J	チップセラコン	01
G2021-2023	US060800	C. CE. CHP	8pF 50V B		J	チップセラコン	01
G2024-2026	US064100	C. CE. CHP	0. 01uF 50V B		J	チップセラコン	01
G2027-2029	US060800	C. CE. CHP	8pF 50V B			チップセラコン	01
G2031	US135100	C. CE. CHP	0. 1uF 16V			チップセラコン	01
G2032	UR237470	C. EL	47uF 16V			ケミコン	01
G2033	US135100	C. CE. CHP	0. 1uF 16V			チップセラコン	01
G2034	UR237470	C. EL	47uF 16V			ケミコン	01
G2035	US135100	C. CE. CHP	0. 1uF 16V			チップセラコン	01
G2036-2037	UR237470	C. EL	47uF 16V			ケミコン	01
G2038	US135100	C. CE. CHP	0. 1uF 16V			チップセラコン	01
G2041	US135100	C. CE. CHP	0. 1uF 16V			チップセラコン	01
G2042	UR237470	C. EL	47uF 16V			ケミコン	01
G2043	US135100	C. CE. CHP	0. 1uF 16V			チップセラコン	01
G2044	UR237470	C. EL	47uF 16V			ケミコン	01
G2045	US135100	C. CE. CHP	0. 1uF 16V			チップセラコン	01
G2046-2047	UR237470	C. EL	47uF 16V			ケミコン	01
G2048	US135100	C. CE. CHP	0. 1uF 16V			チップセラコン	01
G2051	US135100	C. CE. CHP	0. 1uF 16V			チップセラコン	01
G2052	UR237470	C. EL	47uF 16V			ケミコン	01
G2053	US135100	C. CE. CHP	0. 1uF 16V			チップセラコン	01
G2054	UR237470	C. EL	47uF 16V			ケミコン	01
G2055	US135100	C. CE. CHP	0. 1uF 16V			チップセラコン	01
G2056-2057	UR237470	C. EL	47uF 16V			ケミコン	01
G2058	US135100	C. CE. CHP	0. 1uF 16V			チップセラコン	01
G2061	US135100	C. CE. CHP	0. 1uF 16V			チップセラコン	01
G2062	UR237470	C. EL	47uF 16V			ケミコン	01
G2063	US135100	C. CE. CHP	0. 1uF 16V			チップセラコン	01
G2064	UR237470	C. EL	47uF 16V			ケミコン	01
G2065	US135100	C. CE. CHP	0. 1uF 16V			チップセラコン	01
G2066	UR237470	C. EL	47uF 16V			ケミコン	01
G2067	UR238330	C. EL	330uF 16V			ケミコン	01

* New Parts * 新規部品

P.C.B. A-VIDEO

Ref No.	Part No.	Description	Remarks	Markets	部 品 名	ランク
C2068-2069	US135100	C. CE. CHP	0. 1uF 16V		チップセラコン	01
C2070-2071	UR238330	C. EL	330uF 16V		ケミコン	01
C2072	US135100	C. CE. CHP	0. 1uF 16V		チップセラコン	01
C2073	UR266100	C. EL	1uF 50V		ケミコン	01
C2075-2077	US060300	C. CE. CHP	3pF 50V B		チップセラコン	01
C2081	UR266220	C. EL	2. 2uF 50V		ケミコン	
C2082	UR238100	C. EL	100uF 16V		ケミコン	
C2083	US135100	C. CE. CHP	0. 1uF 16V		チップセラコン	01
C2084	US064100	C. CE. CHP	0. 01uF 50V B		チップセラコン	01
C2086	US126100	C. CE. CHP	1uF 10V		チップセラコン	01
C2091	UR237470	C. EL	47uF 16V		ケミコン	01
C2092-2094	US135100	C. CE. CHP	0. 1uF 16V		チップセラコン	01
C2101-2102	US135100	C. CE. CHP	0. 1uF 16V		チップセラコン	01
C2107	US135100	C. CE. CHP	0. 1uF 16V		チップセラコン	01
C2108	UR238470	C. EL	470uF 16V		ケミコン	
C2109	UR238100	C. EL	100uF 16V		ケミコン	
C2110	US135100	C. CE. CHP	0. 1uF 16V		チップセラコン	01
C2131	US135100	C. CE. CHP	0. 1uF 16V		チップセラコン	01
C2132	US126100	C. CE. CHP	1uF 10V		チップセラコン	01
C2133	US135100	C. CE. CHP	0. 1uF 16V		チップセラコン	01
C2501-2505	US135100	C. CE. CHP	0. 1uF 16V	J	チップセラコン	01
C2521-2523	US062100	C. CE. CHP	100pF 50V B		チップセラコン	01
C2524	US135100	C. CE. CHP	0. 1uF 16V		チップセラコン	01
C2525-2527	US062100	C. CE. CHP	100pF 50V B		チップセラコン	01
C2528	US135100	C. CE. CHP	0. 1uF 16V		チップセラコン	01
C2531-2533	US062270	C. CE. CHP	270pF 50V B		チップセラコン	01
C2534	US135100	C. CE. CHP	0. 1uF 16V		チップセラコン	01
C2541-2546	US135100	C. CE. CHP	0. 1uF 16V		チップセラコン	01
C2547-2548	UR238220	C. EL	220uF 16V		ケミコン	01
C2549	US135100	C. CE. CHP	0. 1uF 16V		チップセラコン	01
C2551-2552	US135100	C. CE. CHP	0. 1uF 16V		チップセラコン	01
C2553-2554	UR238220	C. EL	220uF 16V		ケミコン	01
C2555	US135100	C. CE. CHP	0. 1uF 16V		チップセラコン	01
C2561-2564	UR237470	C. EL	47uF 16V		ケミコン	01
C2571-2572	UR238100	C. EL	100uF 16V		ケミコン	
C2573-2574	US135100	C. CE. CHP	0. 1uF 16V		チップセラコン	01
C2581-2582	UR237470	C. EL	47uF 16V		ケミコン	01
C2583	US062220	C. CE. CHP	220pF 50V B		チップセラコン	01
C2585	US062220	C. CE. CHP	220pF 50V B		チップセラコン	01
C2601-2602	UR237470	C. EL	47uF 16V		ケミコン	01
C2603	US135100	C. CE. CHP	0. 1uF 16V		チップセラコン	01
C2611	UR238470	C. EL	470uF 16V		ケミコン	
C2612	US064100	C. CE. CHP	0. 01uF 50V B		チップセラコン	01
C2613	US062120	C. CE. CHP	120pF 50V B		チップセラコン	01
C2614	US062220	C. CE. CHP	220pF 50V B		チップセラコン	01
C2615	UR237100	C. EL	10uF 16V		ケミコン	
C2616	UR237470	C. EL	47uF 16V		ケミコン	01
C2617	US135100	C. CE. CHP	0. 1uF 16V		チップセラコン	01
C2621-2622	US135100	C. CE. CHP	0. 1uF 16V		チップセラコン	01
C2631	UR237100	C. EL	10uF 16V		ケミコン	
C2632	UR266470	C. EL	4. 7uF 50V		ケミコン	
C2633	UR238100	C. EL	100uF 16V		ケミコン	
C2634	UR238330	C. EL	330uF 16V		ケミコン	01
C2641-2642	UR238100	C. EL	100uF 16V		ケミコン	
C2643	US135100	C. CE. CHP	0. 1uF 16V		チップセラコン	01

* New Parts * 新規部品

P.C.B. A-VIDEO

Ref No.	Part No.	Description	Remarks	Markets	部 品 名	ランク	
C2644	US061120	C. CE. CHP	12pF 50V B		JUCRK	チップセラコン	01
C2644	US060800	C. CE. CHP	8pF 50V B		TABGEL	チップセラコン	01
C2645	US061120	C. CE. CHP	12pF 50V B		JUCRK	チップセラコン	01
C2645	US060600	C. CE. CHP	6pF 50V B		TABGEL	チップセラコン	
C2646	US060800	C. CE. CHP	8pF 50V B		JUCRK	チップセラコン	01
C2646	US060600	C. CE. CHP	6pF 50V B		TABGEL	チップセラコン	
C2647-2648	US061240	C. CE. CHP	24pF 50V B			チップセラコン	01
C2649	UR266100	C. EL	1uF 50V			ケミコン	01
C2650	US062470	C. CE. CHP	470pF 50V B			チップセラコン	01
C2651	UR266100	C. EL	1uF 50V			ケミコン	01
C2652	US063120	C. CE. CHP	1200pF 50V B			チップセラコン	01
C2653	US135100	C. CE. CHP	0. 1uF 16V			チップセラコン	01
C2691-2692	US135100	C. CE. CHP	0. 1uF 16V			チップセラコン	01
C2695-2697	US061100	C. CE. CHP	10pF 50V B			チップセラコン	01
D2001-2009	VT332900	DIODE	1SS355		J	ダイオード	01
D2061-2062	VT332900	DIODE	1SS355			ダイオード	01
D2561	VT332900	DIODE	1SS355			ダイオード	01
D2563	VT332900	DIODE	1SS355			ダイオード	01
D2581-2582	VT332900	DIODE	1SS355			ダイオード	01
D2611-2612	VT332900	DIODE	1SS355			ダイオード	01
D2631-2634	VT332900	DIODE	1SS355			ダイオード	01
IC201	X6757A00	IC	NJW1321FP1			IC	08
IC202	X2484A00	IC	TA1318AF			IC	07
IC203	X2904A00	IC	NJM2581M VIDEO AMP			アンプ IC	06
IC204-205	XS790A00	IC	TC74HC4052AF MPX		J	ロジック IC	02
IC206	XY877A00	IC	MM74HC4053SJX			ロジック IC	01
IC207	X6758A00	IC	LA73054-TLM-E			アンプ IC	04
IC211	XY550A00	IC	MM74HC4051SJX			ロジック IC	01
IC213	XY550A00	IC	MM74HC4051SJX			ロジック IC	01
IC215	X4321A00	IC	CD4051BNSR			ロジック IC	01
IC218	X6742A00	IC	LA73050-TLM-E			アンプ IC	04
IC219	X6741A00	IC	LA7106M-TLM-E			アンプ IC	05
IC220	XW939A00	IC	TK15420M VIDEO AMP			アンプ IC	03
IC221	XY877A00	IC	MM74HC4053SJX			ロジック IC	01
IC222	X7779A00	IC	LC709004A-TLM-E			ロジック IC	04
IC223	XZ509A00	IC	TC74VHC04FT INVER			ロジック IC	01
IC224	XY877A00	IC	MM74HC4053SJX			ロジック IC	01
IC225	X7818A00	IC	LC74782JM-8A16-TLM			IC	07
JK201	WD396100	JACK. PIN	LAP5100-1801FC			ピンジャック + S	04
JK202-203	WD396300	JACK. PIN	LAP5100-1601FC			ピンジャック + S	04
PJ201-203	WD398400	CN. DIN	14P YKF45-3011		J	D I Nコネクタ	05
PJ204	WH382000	JACK. PIN	9P G, B, R			ピンジャック 9P	05
PJ205	WD398400	CN. DIN	14P YKF45-3011		J	D I Nコネクタ	05
PJ206	WH381800	JACK. PIN	3P G, B, R			ピンジャック 3P	03
PN201	V9637500	PIN	L=70 #18			スタイルピン	
Q2541-2543	VV655700	TR. DGT	DTC144EKA			デジタルトランジスタ	01
Q2601	VV556400	TR	2SC2412K Q, R, S			トランジスタ	01
Q2631	WF550000	TR	2SC3837K T146 N, P			トランジスタ	01
Q2632	VV556500	TR	2SA1037K Q, R, S			トランジスタ	01
Q2633	WF549900	TR	2SC3906K T146 R, S			トランジスタ	01
Q2634	VZ725900	TR	2SD1938F S, T			トランジスタ	01
Q2641-2642	VV556400	TR	2SC2412K Q, R, S			トランジスタ	01
R2010	HV753100	R. CAR. FP	1 Ω 1/4W		J	不燃化カーボン抵抗	01
R2020	HV753100	R. CAR. FP	1 Ω 1/4W		J	不燃化カーボン抵抗	01
R2068-2069	HV753100	R. CAR. FP	1 Ω 1/4W			不燃化カーボン抵抗	01

* New Parts * 新規部品

P.C.B. A-VIDEO and P.C.B. D-VIDEO

Ref No.	Part No.	Description	Remarks	Markets	部 品 名	ランク	
R2071	HV753100	R. CAR. FP	1 Ω	1/4W		不燃化カーボン抵抗	01
R2086	HV753100	R. CAR. FP	1 Ω	1/4W		不燃化カーボン抵抗	01
R2092	HV753100	R. CAR. FP	1 Ω	1/4W		不燃化カーボン抵抗	01
R2099	HV753100	R. CAR. FP	1 Ω	1/4W		不燃化カーボン抵抗	01
R2104	HV753100	R. CAR. FP	1 Ω	1/4W		不燃化カーボン抵抗	01
R2551-2552	HV753100	R. CAR. FP	1 Ω	1/4W		不燃化カーボン抵抗	01
R2571-2572	HV753100	R. CAR. FP	1 Ω	1/4W		不燃化カーボン抵抗	01
R2608	HV756470	R. CAR. FP	4. 7K Ω	1/4W		不燃化カーボン抵抗	01
R2611	HV753220	R. CAR. FP	2. 2 Ω	1/4W		不燃化カーボン抵抗	01
R2630	HV753220	R. CAR. FP	2. 2 Ω	1/4W		不燃化カーボン抵抗	01
R2635	HV755470	R. CAR. FP	470 Ω	1/4W		不燃化カーボン抵抗	01
R2637	HV755470	R. CAR. FP	470 Ω	1/4W		不燃化カーボン抵抗	01
R2639	HV755470	R. CAR. FP	470 Ω	1/4W		不燃化カーボン抵抗	01
R2641-2642	HV753100	R. CAR. FP	1 Ω	1/4W		不燃化カーボン抵抗	01
R2651	HV755470	R. CAR. FP	470 Ω	1/4W		不燃化カーボン抵抗	01
R2708	HV753100	R. CAR. FP	1 Ω	1/4W		不燃化カーボン抵抗	01
R2711-2712	HV753100	R. CAR. FP	1 Ω	1/4W		不燃化カーボン抵抗	01
ST201	V4040500	SCR. TERM	M3			スクリュー／ターミナル	01
XL201	V5345200	RSNR. CE	CSBLA503KECZF30-B0			セラミック振動子	01
XL202	WD280800	RSNR. CRY5	14. 31818MHz	JUCRK		水晶振動子	03
XL202	WD280900	RSNR. CRY5	17. 734475MHz	TABGEL		水晶振動子	03
	WK647200	P. C. B.	D-VIDEO			PCB DVIDEO	
CB101	WH641400	CN. HDMI	19P SE			HDMIコネクタ	03
CB102	WC197000	CN. FMN	20P TE			FMNコネクタ	04
CB103-106	WH641400	CN. HDMI	19P SE			HDMIコネクタ	03
CB121-122	V8875600	CN	13P TE			JEコネクタ	02
CB185	VM688900	CN. BS. PIN	10P			FFCコネクタ	01
CB186	WC196800	CN	18P TE	FMN		FMNコネクタ	04
CB188	LB919050	CN. BS. PIN	5P			ベース付ポスト	01
C1001	WD758300	C. CE. CHP	10uF	10V		チップセラコン	01
C1002-1004	US135100	C. CE. CHP	0. 1uF	16V		チップセラコン	01
C1005-1006	WD758300	C. CE. CHP	10uF	10V		チップセラコン	01
C1007	US063100	C. CE. CHP	1000pF	50V B		チップセラコン	01
C1008	WD758300	C. CE. CHP	10uF	10V		チップセラコン	01
C1009-1011	US135100	C. CE. CHP	0. 1uF	16V		チップセラコン	01
C1013-1017	US135100	C. CE. CHP	0. 1uF	16V		チップセラコン	01
C1018	WD758300	C. CE. CHP	10uF	10V		チップセラコン	01
C1019	US135100	C. CE. CHP	0. 1uF	16V		チップセラコン	01
C1020	WD758300	C. CE. CHP	10uF	10V		チップセラコン	01
C1021	US135100	C. CE. CHP	0. 1uF	16V		チップセラコン	01
C1022	WD758300	C. CE. CHP	10uF	10V		チップセラコン	01
C1023-1025	US135100	C. CE. CHP	0. 1uF	16V		チップセラコン	01
C1026	US061150	C. CE. CHP	15pF	50V B		チップセラコン	01
C1027	US061120	C. CE. CHP	12pF	50V B		チップセラコン	01
C1028-1038	US135100	C. CE. CHP	0. 1uF	16V		チップセラコン	01
C1039-1040	WD758300	C. CE. CHP	10uF	10V		チップセラコン	01
C1041	US063100	C. CE. CHP	1000pF	50V B		チップセラコン	01
C1042-1045	US135100	C. CE. CHP	0. 1uF	16V		チップセラコン	01
C1046	US063100	C. CE. CHP	1000pF	50V B		チップセラコン	01
C1047	US135100	C. CE. CHP	0. 1uF	16V		チップセラコン	01
C1048	US063100	C. CE. CHP	1000pF	50V B		チップセラコン	01
C1049-1053	US135100	C. CE. CHP	0. 1uF	16V		チップセラコン	01

*

* New Parts * 新規部品

P.C.B. D-VIDEO

Ref No.	Part No.	Description	Remarks	Markets	部 品 名	ランク
C1054	WD758300	C. CE. CHP 10uF 10V			チップセラコン	01
C1055-1059	US135100	C. CE. CHP 0. 1uF 16V			チップセラコン	01
C1060	US063100	C. CE. CHP 1000pF 50V B			チップセラコン	01
C1061-1064	US135100	C. CE. CHP 0. 1uF 16V			チップセラコン	01
C1065	US063100	C. CE. CHP 1000pF 50V B			チップセラコン	01
C1066-1068	WD758300	C. CE. CHP 10uF 10V			チップセラコン	01
C1069-1072	US135100	C. CE. CHP 0. 1uF 16V			チップセラコン	01
C1073	US064100	C. CE. CHP 0. 01uF 50V B			チップセラコン	01
C1074-1075	US135100	C. CE. CHP 0. 1uF 16V			チップセラコン	01
C1076	WD758300	C. CE. CHP 10uF 10V			チップセラコン	01
C1077	US135100	C. CE. CHP 0. 1uF 16V			チップセラコン	01
C1078	US063100	C. CE. CHP 1000pF 50V B			チップセラコン	01
C1079-1080	US135100	C. CE. CHP 0. 1uF 16V			チップセラコン	01
C1081	WD758300	C. CE. CHP 10uF 10V			チップセラコン	01
C1082-1084	US135100	C. CE. CHP 0. 1uF 16V			チップセラコン	01
C1087-1090	US135100	C. CE. CHP 0. 1uF 16V			チップセラコン	01
C1093	US064100	C. CE. CHP 0. 01uF 50V B			チップセラコン	01
C1094-1096	US135100	C. CE. CHP 0. 1uF 16V			チップセラコン	01
C1101-1105	US135100	C. CE. CHP 0. 1uF 16V			チップセラコン	01
C1106	US060700	C. CE. CHP 7pF 50V B			チップセラコン	01
C1201-1202	US135100	C. CE. CHP 0. 1uF 16V			チップセラコン	01
C1203-1206	WD758300	C. CE. CHP 10uF 10V			チップセラコン	01
C1207	US135100	C. CE. CHP 0. 1uF 16V			チップセラコン	01
C1208	US064100	C. CE. CHP 0. 01uF 50V B			チップセラコン	01
C1209	WD758300	C. CE. CHP 10uF 10V			チップセラコン	01
C1210-1211	US135100	C. CE. CHP 0. 1uF 16V			チップセラコン	01
C1212-1213	WD758300	C. CE. CHP 10uF 10V			チップセラコン	01
C1214-1217	US135100	C. CE. CHP 0. 1uF 16V			チップセラコン	01
C1218	WD758300	C. CE. CHP 10uF 10V			チップセラコン	01
C1219-1220	US064100	C. CE. CHP 0. 01uF 50V B			チップセラコン	01
C1221-1222	WD758300	C. CE. CHP 10uF 10V			チップセラコン	01
C1223-1228	US135100	C. CE. CHP 0. 1uF 16V			チップセラコン	01
C1229	US063820	C. CE. CHP 8200pF 50V B			チップセラコン	01
C1230	US063100	C. CE. CHP 1000pF 50V B			チップセラコン	01
C1231	US063220	C. CE. CHP 2200pF 50V B			チップセラコン	01
C1232	US135100	C. CE. CHP 0. 1uF 16V			チップセラコン	01
C1233	US063220	C. CE. CHP 2200pF 50V B			チップセラコン	01
C1234	US064100	C. CE. CHP 0. 01uF 50V B			チップセラコン	01
C1235	US135100	C. CE. CHP 0. 1uF 16V			チップセラコン	01
C1236	US063390	C. CE. CHP 3900pF 50V B			チップセラコン	01
C1237	US135150	C. CE. CHP 0. 15uF 16V			チップセラコン	01
C1238	US064100	C. CE. CHP 0. 01uF 50V B			チップセラコン	01
C1239	US135100	C. CE. CHP 0. 1uF 16V			チップセラコン	01
C1240	US034820	C. CE. CHP 0. 082uF 16V K			チップセラコン	01
C1241	WD758300	C. CE. CHP 10uF 10V			チップセラコン	01
C1242	US135100	C. CE. CHP 0. 1uF 16V			チップセラコン	01
C1243	US064100	C. CE. CHP 0. 01uF 50V B			チップセラコン	01
C1244	US063390	C. CE. CHP 3900pF 50V B			チップセラコン	01
C1245	US063820	C. CE. CHP 8200pF 50V B			チップセラコン	01
C1246	US135150	C. CE. CHP 0. 15uF 16V			チップセラコン	01
C1247	US064100	C. CE. CHP 0. 01uF 50V B			チップセラコン	01
C1248	US135100	C. CE. CHP 0. 1uF 16V			チップセラコン	01
C1249	US060700	C. CE. CHP 7pF 50V B			チップセラコン	01
C1250	US064100	C. CE. CHP 0. 01uF 50V B			チップセラコン	01
C1251-1252	US135100	C. CE. CHP 0. 1uF 16V			チップセラコン	01

* New Parts * 新規部品

P.C.B. D-VIDEO

Ref No.	Part No.	Description	Remarks	Markets	部 品 名	ランク	
C1253	US060700	C. CE. CHP	7pF	50V B		チップセラコン	01
C1254-1257	US135100	C. CE. CHP	0. 1uF	16V		チップセラコン	01
C1258	WD758300	C. CE. CHP	10uF	10V		チップセラコン	01
C1259	US135100	C. CE. CHP	0. 1uF	16V		チップセラコン	01
C1260	WD758300	C. CE. CHP	10uF	10V		チップセラコン	01
C1261-1263	US064100	C. CE. CHP	0. 01uF	50V B		チップセラコン	01
C1264-1266	US135100	C. CE. CHP	0. 1uF	16V		チップセラコン	01
C1271-1273	US135100	C. CE. CHP	0. 1uF	16V		チップセラコン	01
C1301-1302	UF018100	C. EL. CHP	100uF	6. 3V		チップケミコン	01
C1303	UF037470	C. EL. CHP	47uF	16V		チップケミコン	01
C1450	WD758300	C. CE. CHP	10uF	10V		チップセラコン	01
C1451-1458	US135100	C. CE. CHP	0. 1uF	16V		チップセラコン	01
C1459	WD758300	C. CE. CHP	10uF	10V		チップセラコン	01
C1460-1468	US135100	C. CE. CHP	0. 1uF	16V		チップセラコン	01
C1469	WD758300	C. CE. CHP	10uF	10V		チップセラコン	01
C1470-1491	US135100	C. CE. CHP	0. 1uF	16V		チップセラコン	01
C1492-1493	WD758300	C. CE. CHP	10uF	10V		チップセラコン	01
C1494	US060700	C. CE. CHP	7pF	50V B		チップセラコン	01
C1604-1612	US135100	C. CE. CHP	0. 1uF	16V		チップセラコン	01
C1613	WD758300	C. CE. CHP	10uF	10V		チップセラコン	01
C1614-1616	US135100	C. CE. CHP	0. 1uF	16V		チップセラコン	01
C1617	US063100	C. CE. CHP	1000pF	50V B		チップセラコン	01
C1618	WD758300	C. CE. CHP	10uF	10V		チップセラコン	01
C1619-1625	US135100	C. CE. CHP	0. 1uF	16V		チップセラコン	01
C1626	WD758300	C. CE. CHP	10uF	10V		チップセラコン	01
C1627-1631	US135100	C. CE. CHP	0. 1uF	16V		チップセラコン	01
C1632	US063100	C. CE. CHP	1000pF	50V B		チップセラコン	01
C1633	WD758300	C. CE. CHP	10uF	10V		チップセラコン	01
C1634-1636	US135100	C. CE. CHP	0. 1uF	16V		チップセラコン	01
C1639	WD758300	C. CE. CHP	10uF	10V		チップセラコン	01
C1801-1802	US063100	C. CE. CHP	1000pF	50V B		チップセラコン	01
C1803-1804	US135100	C. CE. CHP	0. 1uF	16V		チップセラコン	01
C1805	US063100	C. CE. CHP	1000pF	50V B		チップセラコン	01
C1806-1809	US135100	C. CE. CHP	0. 1uF	16V		チップセラコン	01
C1810	WD758300	C. CE. CHP	10uF	10V		チップセラコン	01
C1812-1813	US135100	C. CE. CHP	0. 1uF	16V		チップセラコン	01
C1815-1826	US135100	C. CE. CHP	0. 1uF	16V		チップセラコン	01
C1827	US064100	C. CE. CHP	0. 01uF	50V B		チップセラコン	01
C1828-1830	US135100	C. CE. CHP	0. 1uF	16V		チップセラコン	01
C1831	US126100	C. CE. CHP	1uF	10V		チップセラコン	01
C1832-1835	US135100	C. CE. CHP	0. 1uF	16V		チップセラコン	01
C1838	US135100	C. CE. CHP	0. 1uF	16V		チップセラコン	01
C1840	US135100	C. CE. CHP	0. 1uF	16V		チップセラコン	01
C1841-1861	US061220	C. CE. CHP	22pF	50V B		チップセラコン	01
C1862	US135100	C. CE. CHP	0. 1uF	16V		チップセラコン	01
C1863-1864	US061220	C. CE. CHP	22pF	50V B		チップセラコン	01
C1865	US064100	C. CE. CHP	0. 01uF	50V B		チップセラコン	01
C1866-1867	US061220	C. CE. CHP	22pF	50V B		チップセラコン	01
C1868-1869	US135100	C. CE. CHP	0. 1uF	16V		チップセラコン	01
C1870	US064100	C. CE. CHP	0. 01uF	50V B		チップセラコン	01
C1873	US135100	C. CE. CHP	0. 1uF	16V		チップセラコン	01
C1875	US064100	C. CE. CHP	0. 01uF	50V B		チップセラコン	01
C1876	UF037100	C. EL. CHP	10uF	16V		チップケミコン	01
C1877	US135100	C. CE. CHP	0. 1uF	16V		チップセラコン	01
C1878	US126100	C. CE. CHP	1uF	10V		チップセラコン	01

* New Parts * 新規部品

P.C.B. D-VIDEO

Ref No.	Part No.	Description	Remarks	Markets	部 品 名	ランク
C1879	US135100	C. CE. CHP	0. 1uF 16V		チップセラコン	01
C1880	UF017220	C. EL. CHP	22uF 6. 3V		チップケミコン	01
C1901	UF037470	C. EL. CHP	47uF 16V		チップケミコン	01
C1902-1904	UF037100	C. EL. CHP	10uF 16V		チップケミコン	01
C1905-1907	UF017220	C. EL. CHP	22uF 6. 3V		チップケミコン	01
C1908-1910	UF037100	C. EL. CHP	10uF 16V		チップケミコン	01
C1911-1913	UF017220	C. EL. CHP	22uF 6. 3V		チップケミコン	01
C1915	UF037100	C. EL. CHP	10uF 16V		チップケミコン	01
C1917	UF017220	C. EL. CHP	22uF 6. 3V		チップケミコン	01
C1919-1927	US135100	C. CE. CHP	0. 1uF 16V		チップセラコン	01
C1951-1969	US135100	C. CE. CHP	0. 1uF 16V		チップセラコン	01
D1009-1010	WE674800	DIODE	AVRL161A1R1NTB		チップバリスタ	01
D1011	VV220700	DIODE. SHOT	RB501V-40		ショットキーダイオード	01
D1012	VT332900	DIODE	1SS355		ダイオード	01
* D1014-1021	WP385600	PESD	PESD0603-240		ポリマーESD	
* D1023-1030	WP385600	PESD	PESD0603-240		ポリマーESD	
* D1032-1039	WP385600	PESD	PESD0603-240		ポリマーESD	
* D1041-1048	WP385600	PESD	PESD0603-240		ポリマーESD	
D1049-1056	WE674800	DIODE	AVRL161A1R1NTB		チップバリスタ	01
D1203	V8960900	DIODE. ZENR	MA8024-(TX) 2. 4V		ツェナーダイオード	01
D1601	VT332900	DIODE	1SS355		ダイオード	01
D1801-1816	VT332900	DIODE	1SS355		ダイオード	01
D1818	VT332900	DIODE	1SS355		ダイオード	01
D1820-1822	VT332900	DIODE	1SS355		ダイオード	01
F1001	V2997600	SW. POLY	SMDC050-02		ポリスイッチ	01
IC103-104	X8900A00	IC	CXB1442AR-T4		IC	06
IC105	XZ287A00	IC	SN74LVC245APWR		ロジックIC	02
IC106	X7741A00	IC	NJM2867F3-05 (TE1)		電源IC	02
IC107	X8527A00	IC	TC7WZ04FK		ロジックIC	01
IC108	X0199B00	IC	TC74VHC157FT (EL, K)		ロジックIC	01
IC109	X8144A00	IC	SN74CBT3257CPWR		ロジックIC	04
IC110-111	X8294A00	IC	M24C02-WDW6TP		メモリIC	03
IC112	X8144A00	IC	SN74CBT3257CPWR		ロジックIC	04
IC113	X8005A00	IC	SN74CBT3253CPWR		ロジックIC	04
IC114	X8526A00	IC	TC7WZ02FK (TE85L, F)		ロジックIC	01
IC115	X5647A00	IC	SN74LV32APWR OR		ロジックIC	01
IC116	X8398A00	IC	TC7SET08FU (T5L, JF)		ロジックIC	01
IC121	X6848A00	IC	LA73053-TLM-E		アンプIC	05
IC122	X7171A00	IC	SN74LVC2G125DCUR		ロジックIC	03
IC123	X8838A00	IC	ADV7342BSTZ		ICビデオエンコーダ	11
IC124	X6802A00	IC	ADV7401BSTZ-80		ビデオデコーダ	14
IC144	XZ414D00	IC	W9864G6GH-7 SDRAM		メモリIC 64M	05
IC145	X8839A00	IC	IP00C772		IC デジタル	09
IC164-169	XZ287A00	IC	SN74LVC245APWR		ロジックIC	02
IC170	X7762A00	IC	ABT1010		IC	14
IC171-173	XZ283A00	IC	SN74LVTH245APW BUS		ロジックIC	04
* IC181	YA003A00	IC. MEMORY	S29AL004D70TFI020	written	メモリIC 4M	
IC182	X7909A00	IC. CPU	M30845MW-001-GP	MASK ROM	IC CPU	11
IC183	X7886A00	IC	R1171S331B-E2-F		電源IC	03
IC184	X8897A00	IC	R1172S331B-E2-F		電源IC	03
IC185	X7886A00	IC	R1171S331B-E2-F		電源IC	03
IC186	X8009A00	IC	R1131N181D		電源IC	03
IC187	X8147A00	IC	R3112N421A-TR-F		ロジックIC	01
IC188	X8943A00	IC	R1130H181B-T1-F		電源IC	03
IC189	X8942A00	IC	R1171S181B-E2-F		電源IC	04

* New Parts * 新規部品

P.C.B. D-VIDEO and P.C.B. FL

Ref No.	Part No.	Description	Remarks	Markets	部 品 名	ランク
IC191	X7887A00	IC	R1172S181B-E2-F		電源 I C	03
IC192	X3586B00	IC	TC74VHCT08AFT EL, K		ロジック I C	01
IC196	X8404A00	IC	TC7SET125FU (TE85LF		ロジック I C	01
IC198	X8944A00	IC	R1154H050B-T1-F		電源 I C	03
PN181-182	V9637500	PIN	L=70 #18		スタイルピン	
Q1001-1006	VQ986700	TR	2SC4081 T106		トランジスタ	01
Q1007	WE834500	FET	UPA672T-T1-A		F E T	01
Q1801-1807	WH445000	FET	3LN01C-TB-E		F E T	01
Q1808-1809	VQ986700	TR	2SC4081 T106		トランジスタ	01
Q1811-1812	VQ986700	TR	2SC4081 T106		トランジスタ	01
Q1813	WH445000	FET	3LN01C-TB-E		F E T	01
R1878	WB784100	R. MTL. FLM	1.2 Ω 1W		金属被膜抵抗	01
ST101	V4040500	SCR. TERM	M3		スクリューノターミナル	01
XL101	WH625000	RSNR. CRY5	27MHz		水晶振動子	03
XL121	VZ772700	RSNR. CRY5	28.63636MHz		水晶振動子	03
XL181	V9864200	RSNR. CE	10.0MHz		セラミック発振子	01
	WP408600	P. C. B.	FL		J P C B F L	
	WP408700	P. C. B.	FL		UCRTKABGEL P C B F L	
CB901	VN520900	CN. BS. PIN	26P TE		F F Cコネクター	02
CB951-952	V8810200	CN. BS. PIN	9P TE		J Eコネクター	02
CB953	WE222000	CN. BS. PIN	20P SE		F F Cコネクター	03
CB954	V9357000	CN	19P TE		J Eコネクター	
CB955-956	V8875600	CN	13P TE		J Eコネクター	02
CB957	WA894400	CN. FMN	18P TE FMN		FMNコネクター	02
CB958	V9357000	CN	19P TE		J Eコネクター	
CB959-960	V8875600	CN	13P TE		J Eコネクター	02
CB962	V9357000	CN	19P TE		J Eコネクター	
CB963	V7827000	CN	20P TE TUC SERIES		コネクタープラグ	01
CB965	V7828700	SOCKET	20P SE TUC SERIES		コネクターソケット	01
CB967	V8810200	CN. BS. PIN	9P TE		J Eコネクター	02
CB968	V6509500	SOCKET	9P SE 3170		コネクターソケット	04
CB969	V9357000	CN	19P TE		J Eコネクター	
CB970	VQ045500	CN. BS. PIN	26P		F F Cコネクター	02
CB971	VM929900	CN. BS. PIN	15P		F P Cコネクター	01
CB972-973	V8810200	CN. BS. PIN	9P TE		J Eコネクター	02
CB974	VU446000	CN. BS. PIN	15P TE		J E コネクタ	02
C9001	UR267470	C. EL	47uF 50V		ケミコン	01
C9002	US135100	C. CE. CHP	0.1uF 16V		チップセラコン	01
C9003-9004	US064100	C. CE. CHP	0.01uF 50V B		チップセラコン	01
C9008	US064100	C. CE. CHP	0.01uF 50V B		チップセラコン	01
C9010	US064100	C. CE. CHP	0.01uF 50V B		チップセラコン	01
C9011	UM388100	C. EL	100uF 10V		ケミコン	01
C9012-9013	US064100	C. CE. CHP	0.01uF 50V B		チップセラコン	01
C9014	US135100	C. CE. CHP	0.1uF 16V		チップセラコン	01
C9015	US064100	C. CE. CHP	0.01uF 50V B		チップセラコン	01
C9016	UR218330	C. EL	330uF 6.3V		ケミコン	
C9017	US135100	C. CE. CHP	0.1uF 16V		チップセラコン	01
C9020	US062100	C. CE. CHP	100pF 50V B		チップセラコン	01
C9021	US061470	C. CE. CHP	47pF 50V B		チップセラコン	01
C9022	US135100	C. CE. CHP	0.1uF 16V		チップセラコン	01
C9023	UR218330	C. EL	330uF 6.3V		ケミコン	
C9024	US062100	C. CE. CHP	100pF 50V B		チップセラコン	01

*
*

* New Parts * 新規部品

P.C.B. FL and P.C.B. NET

Ref No.	Part No.	Description	Remarks	Markets	部 品 名	ランク
C9030	US064100	C. CE. CHP	0.01uF 50V B		チップセラコン	01
C9501	US064100	C. CE. CHP	0.01uF 50V B		チップセラコン	01
C9502	US135100	C. CE. CHP	0.1uF 16V		チップセラコン	01
C9503	UR237470	C. EL	47uF 16V		ケミコン	01
C9504-9509	US135100	C. CE. CHP	0.1uF 16V		チップセラコン	01
D9005-9006	VU991500	DIODE. ZENR	MA8039-H 4V		ツェナーダイオード	01
D9015	VT332900	DIODE	1SS355	UCRTKABGEL	ダイオード	01
D9017	VT332900	DIODE	1SS355	UCRTKABGEL	ダイオード	01
D9021-9022	VT332900	DIODE	1SS355		ダイオード	01
D9023	VT332900	DIODE	1SS355	UCRTKABGEL	ダイオード	01
D9024-9025	VT332900	DIODE	1SS355	UCRTKABGEL	ダイオード	01
D9501	VT332900	DIODE	1SS355	UCRTKABGEL	ダイオード	01
D9502	VT332900	DIODE	1SS355	UCRTKABGEL	ダイオード	01
D9503	VT332900	DIODE	1SS355	UCRTKABGEL	ダイオード	01
D9504	VT332900	DIODE	1SS355	UCRTKABGEL	ダイオード	01
IC901-902	X7821A00	IC	PT6302LQ-008 (L)		I C	07
IC951	X6876A00	IC	ADM222ARZ		I C	06
JK951-952	V9435700	JACK. MNI	MSJ-035-12APC	UCRTKABGEL	モノラル ミニジャック	01
PN902	V9637500	PIN	L=70 #18		スタイルピン	
PN951-952	V9637500	PIN	L=70 #18		スタイルピン	
Q9001-9009	WC529400	TR	KTC3875S Y GR RTK		トランジスタ	01
Q9010	VV655400	TR. DGT	DTC114EKA	UCRTKABGEL	デジタルトランジスタ	01
Q9501	VP872600	TR	2SA1708 S, T	UCRTKABGEL	トランジスタ	01
Q9502	VV655700	TR. DGT	DTC144EKA	UCRTKABGEL	デジタルトランジスタ	01
Q9503	VP872600	TR	2SA1708 S, T	UCRTKABGEL	トランジスタ	01
Q9504	VV655700	TR. DGT	DTC144EKA	UCRTKABGEL	デジタルトランジスタ	01
R9002	HL005100	R. MTL. OXD	100 Ω 1/2W		酸化金属被膜抵抗	
R9004	HL005100	R. MTL. OXD	100 Ω 1/2W		酸化金属被膜抵抗	
R9507-9508	HF354270	R. CAR	27 Ω 1/2W J	UCRTKABGEL	カーボン抵抗	
ST951-953	V4040500	SCR. TERM	M3		スクリュー/ターミナル	01
SW901-902	V4757100	SW. TACT	EVQ11A		タクトSW	01
SW904-905	V4757100	SW. TACT	EVQ11A		タクトSW	01
SW907	V4757100	SW. TACT	EVQ11A		タクトSW	01
SW908	V4757100	SW. TACT	EVQ11A	UCRTKABGEL	タクトSW	01
SW909	V4757100	SW. TACT	EVQ11A		タクトSW	01
SW915-916	V4757100	SW. TACT	EVQ11A	UCRTKABGEL	タクトSW	01
U9001	V8210200	L. DTCT	GP1UD271XK		リモコン受光ユニット	03
* V9001	WP195500	FL. DSPLY	HNA-16ML15T		蛍光表示管	
	V6007000	SHEET			シート/FL	03
	V3747400	SPACER. FL	T4x6x18		スペーサ/FL	01
	WF649700	SUPRT			サポート/FL	01
*	WP410800	P. C. B.	NET	JRTKABGEL	P C B N E T	
CB601	VQ044200	CN. BS. PIN	6P	JRTKABGEL	FFCコネクター	01
C601-602	US135100	C. CE. CHP	0.1uF 16V	JRTKABGEL	チップセラコン	01
C604	US135100	C. CE. CHP	0.1uF 16V	JRTKABGEL	チップセラコン	01
C605	UB446100	C. CE. CHP	1uF 16V	JRTKABGEL	チップセラコン	01
C606	US135100	C. CE. CHP	0.1uF 16V	JRTKABGEL	チップセラコン	01
C608	UF118330	C. EL. CHP	330uF 6.3V	JRTKABGEL	チップケミコン	01
C609	UB446100	C. CE. CHP	1uF 16V	JRTKABGEL	チップセラコン	01
C610	WD758300	C. CE. CHP	10uF 10V	JRTKABGEL	チップセラコン	01
C612	US135100	C. CE. CHP	0.1uF 16V	JRTKABGEL	チップセラコン	01
C614-615	US061220	C. CE. CHP	22pF 50V B	JRTKABGEL	チップセラコン	01

* New Parts * 新規部品

P.C.B. NET

Ref No.	Part No.	Description	Remarks	Markets	部 品 名	ランク	
C616	US135100	C. CE. CHP	0. 1uF 16V		JRTKABGEL	チップセラコン	01
C618-619	US061120	C. CE. CHP	12pF 50V B		JRTKABGEL	チップセラコン	01
C621-622	US063100	C. CE. CHP	1000pF 50V B		JRTKABGEL	チップセラコン	01
C623-630	US135100	C. CE. CHP	0. 1uF 16V		JRTKABGEL	チップセラコン	01
C632-633	US135100	C. CE. CHP	0. 1uF 16V		JRTKABGEL	チップセラコン	01
C635-637	US135100	C. CE. CHP	0. 1uF 16V		JRTKABGEL	チップセラコン	01
C638	UB446100	C. CE. CHP	1uF 16V		JRTKABGEL	チップセラコン	01
C639	UF018100	C. EL. CHP	100uF 6. 3V		JRTKABGEL	チップケミコン	01
C640	US135100	C. CE. CHP	0. 1uF 16V		JRTKABGEL	チップセラコン	01
C642-654	US135100	C. CE. CHP	0. 1uF 16V		JRTKABGEL	チップセラコン	01
C655	UF018100	C. EL. CHP	100uF 6. 3V		JRTKABGEL	チップケミコン	01
C656	UB446100	C. CE. CHP	1uF 16V		JRTKABGEL	チップセラコン	01
C657-658	US135100	C. CE. CHP	0. 1uF 16V		JRTKABGEL	チップセラコン	01
C660	UF018100	C. EL. CHP	100uF 6. 3V		JRTKABGEL	チップケミコン	01
C661-662	US135100	C. CE. CHP	0. 1uF 16V		JRTKABGEL	チップセラコン	01
C663	UB446100	C. CE. CHP	1uF 16V		JRTKABGEL	チップセラコン	01
C664	US135100	C. CE. CHP	0. 1uF 16V		JRTKABGEL	チップセラコン	01
C665	UB446100	C. CE. CHP	1uF 16V		JRTKABGEL	チップセラコン	01
C666-667	US135100	C. CE. CHP	0. 1uF 16V		JRTKABGEL	チップセラコン	01
C671	UB446100	C. CE. CHP	1uF 16V		JRTKABGEL	チップセラコン	01
C672-673	US135100	C. CE. CHP	0. 1uF 16V		JRTKABGEL	チップセラコン	01
C677-680	US135100	C. CE. CHP	0. 1uF 16V		JRTKABGEL	チップセラコン	01
C682-697	US135100	C. CE. CHP	0. 1uF 16V		JRTKABGEL	チップセラコン	01
C751	US064100	C. CE. CHP	0. 01uF 50V B		JRTKABGEL	チップセラコン	01
C753	US135100	C. CE. CHP	0. 1uF 16V		JRTKABGEL	チップセラコン	01
C754	UF037100	C. EL. CHP	10uF 16V		JRTKABGEL	チップケミコン	01
C755	UF038100	C. EL. CHP	100uF 16V		JRTKABGEL	チップケミコン	01
C757	US135100	C. CE. CHP	0. 1uF 16V		JRTKABGEL	チップセラコン	01
C758	US061150	C. CE. CHP	15pF 50V B		JRTKABGEL	チップセラコン	01
C759-760	UF037470	C. EL. CHP	47uF 16V		JRTKABGEL	チップケミコン	01
C761-762	UF037100	C. EL. CHP	10uF 16V		JRTKABGEL	チップケミコン	01
C763	US061120	C. CE. CHP	12pF 50V B		JRTKABGEL	チップセラコン	01
C764-767	US163100	C. CE. CHP	1000pF 50V		JRTKABGEL	チップセラコン	01
C768	US135100	C. CE. CHP	0. 1uF 16V		JRTKABGEL	チップセラコン	01
C770-771	UF037100	C. EL. CHP	10uF 16V		JRTKABGEL	チップケミコン	01
C772-773	US135100	C. CE. CHP	0. 1uF 16V		JRTKABGEL	チップセラコン	01
C774	WD758300	C. CE. CHP	10uF 10V		JRTKABGEL	チップセラコン	01
C777-780	US135100	C. CE. CHP	0. 1uF 16V		JRTKABGEL	チップセラコン	01
C781	US163100	C. CE. CHP	1000pF 50V		JRTKABGEL	チップセラコン	01
D601	VT332900	DIODE	1SS355		JRTKABGEL	ダイオード	01
D602	VQ721800	DIODE. CHP	MA732		JRTKABGEL	チップダイオード	01
D753	VV658000	DIODE. ZENR	RLZ5. 1A 5. 1V		JRTKABGEL	ツェナーダイオード	01
IC601	X5382A00	IC	BD4830FVE-TR		JRTKABGEL	リセット I C	02
IC602	X5539A00	IC	SN74LVC14APWR		JRTKABGEL	ロジック I C	01
IC604	X3401A00	IC	PQ018EZ01ZP 1. 8V		JRTKABGEL	電源 I C	03
IC605	X7550A00	IC	SN74LVC1GU04DCKR		JRTKABGEL	ロジック I C	02
IC609	X4107A00	IC	MIC2026-2BM		JRTKABGEL	電源 I C	05
IC610	X5620B00	IC. CPU	EP9301-CQZ CPU		JRTKABGEL	I C CPU	16
IC611	X3585E00	IC. MEMORY	K4S281632K-UC75000		JRTKABGEL	メモリ I C 1 2 8 M	05
* IC613	YA020A00	IC. MEMORY	MX29LV320BTC-90G	written	JRTKABGEL	メモリ I C 3 2 M	
IC614	X3542A00	IC	74LCX07MTCX		JRTKABGEL	ロジック I C	01
IC615-616	X7678A00	IC	SN74LV163APWR CNT		JRTKABGEL	ロジック I C	01
IC617	X5534A00	IC	SN74LV74APWR D-FF		JRTKABGEL	ロジック I C	01
IC751	X7375A00	IC	PCM1781DBQR		JRTKABGEL	I C	04
IC752	X7378A00	IC	NJM4565M (TE1)		JRTKABGEL	アンプ I C	01

* New Parts * 新規部品

P.C.B. NET and P.C.B. CONNECT

Ref No.	Part No.	Description	Remarks	Markets	部 品 名	ランク	
	IC753	IC	SN74LVC3GU04DCTR		JRTKABGEL	ロジック I C	
*	Q601	TR. DGT	DTC114EKA		JRTKABGEL	デジタルトランジスタ	01
	R753	R. MTL. FLM	150 Ω 1W		JRTKABGEL	金属被膜抵抗	
	ST601-602	SCR. TERM	M3		JRTKABGEL	スクリュー／ターミナル	01
	XL601	WG970800	RSNR. CRY5	32. 768KHz	JRTKABGEL	水晶振動子	04
	XL602	WD391000	RSNR. CRY5	14. 7456MHz	JRTKABGEL	水晶振動子	03
	XL751	V3625600	RSNR. CRY5	22. 5792MHz	JRTKABGEL	水晶振動子	03
*		WP155800	P. C. B.	CONNECT	U	PCB CONNECT	
*		WP155900	P. C. B.	CONNECT	C	PCB CONNECT	
	CB901	LB919030	CN. BS. PIN	3P	U	ベース付ポスト	01
	CB903	VU443800	CN. JE	15P SE	U	J E コネクタープラグ	01
	CB952	VQ044200	CN. BS. PIN	6P	UC	F F C コネクター	01
	C900	US064100	C. CE. CHP	0. 01uF 50V B	U	チップセラコン	01
	C901	US135100	C. CE. CHP	0. 1uF 16V	U	チップセラコン	01
*	C902	UR219220	C. EL	2200uF 6. 3V	U	ケミコン	
	C903	US062100	C. CE. CHP	100pF 50V B	U	チップセラコン	01
	C904	UM397470	C. EL	47uF 16V	U	ケミコン	01
	C905	US062100	C. CE. CHP	100pF 50V B	U	チップセラコン	01
	C907	US062100	C. CE. CHP	100pF 50V B	U	チップセラコン	01
	C910	US062100	C. CE. CHP	100pF 50V B	U	チップセラコン	01
	C912-913	UM397100	C. EL	10uF 16V	U	ケミコン	01
	C914	US062220	C. CE. CHP	220pF 50V B	U	チップセラコン	01
	C916	UM397470	C. EL	47uF 16V	U	ケミコン	01
	C917	US062220	C. CE. CHP	220pF 50V B	U	チップセラコン	01
	C918-919	UM397100	C. EL	10uF 16V	U	ケミコン	01
	C920-921	US135100	C. CE. CHP	0. 1uF 16V	U	チップセラコン	01
	C950	US062220	C. CE. CHP	220pF 50V B	UC	チップセラコン	01
	C951	US063100	C. CE. CHP	1000pF 50V B	UC	チップセラコン	01
	C952-956	US062220	C. CE. CHP	220pF 50V B	UC	チップセラコン	01
	C957	UM397470	C. EL	47uF 16V	UC	ケミコン	01
	C959	US063100	C. CE. CHP	1000pF 50V B	UC	チップセラコン	01
	C960	US062220	C. CE. CHP	220pF 50V B	UC	チップセラコン	01
	C961	UM397470	C. EL	47uF 16V	UC	ケミコン	01
	C962-964	US062220	C. CE. CHP	220pF 50V B	UC	チップセラコン	01
	C965	UM397100	C. EL	10uF 16V	UC	ケミコン	01
	C966	UM397470	C. EL	47uF 16V	UC	ケミコン	01
	C967-969	UM397100	C. EL	10uF 16V	UC	ケミコン	01
	C970	US135100	C. CE. CHP	0. 1uF 16V	UC	チップセラコン	01
	C975	US135100	C. CE. CHP	0. 1uF 16V	U	チップセラコン	01
	C976	UM397470	C. EL	47uF 16V	UC	ケミコン	01
	D900-901	VT332900	DIODE	1SS355	U	ダイオード	01
	D904	VU992600	DIODE. ZENR	MA8051-M 5. 1V	U	ツェナーダイオード	01
	D950	VU992600	DIODE. ZENR	MA8051-M 5. 1V	UC	ツェナーダイオード	01
	D952	VU992600	DIODE. ZENR	MA8051-M 5. 1V	UC	ツェナーダイオード	01
	D953-954	VT332900	DIODE	1SS355	UC	ダイオード	01
	IC901	X7378A00	IC	NJM4565M (TE1)	U	アンプ I C	01
	IC950	X7378A00	IC	NJM4565M (TE1)	UC	アンプ I C	01
	IC951	XW814A00	IC	TC7SET32FU	UC	ロジック I C	01
*	JK950	WP418600	JACK. DIN	8P TCS7927-6821177	UC	ミニ D I N コネクター	
	PN901	V9637500	PIN	L=70 #18	U	スタイルピン	
	Q900	WH445000	FET	3LN01C-TB-E	U	F E T	01
	Q951	VV655200	TR. DGT	DTA143EKA	UC	デジタルトランジスタ	01

* New Parts * 新規部品

Carbon Resistors

Value	1/4W Type Part No.	1/6W Type Part No.	Value	1/4W Type Part No.	1/6W Type Part No.
1.0 Ω	HJ35 3100	HF85 3100	11 kΩ	HF45 7110	HF45 7110
1.8 Ω	HJ35 3180	*	12 kΩ	HJ35 7120	HF85 7120
2.2 Ω	HJ35 3220	HF85 3220	13 kΩ	HF45 7130	HF45 7130
3.3 Ω	HJ35 3330	HF85 3330	15 kΩ	HF45 7150	HF45 7150
4.7 Ω	HJ35 3470	HF45 3470	18 kΩ	HF45 7180	HF45 7180
5.6 Ω	HJ35 3560	HF85 3560	22 kΩ	HF45 7220	HF45 7220
10 Ω	HF45 4100	HF45 4100	24 kΩ	HF45 7240	HF45 7240
15 Ω	HJ35 4150	HF85 4150	27 kΩ	HJ35 7270	HF85 7270
22 Ω	HF45 4220	HF45 4220	30 kΩ	HF45 7300	HF45 7300
27 Ω	HJ35 4270	HF85 4270	33 kΩ	HF45 7330	HF45 7330
33 Ω	HF45 4330	HF45 4330	36 kΩ	HF45 7360	HF45 7360
39 Ω	HJ35 4470	HF85 4390	39 kΩ	HF45 7390	HF45 7390
47 Ω	HF45 4470	HF45 4470	47 kΩ	HF45 7470	HF45 7470
56 Ω	HF45 4560	HF45 4560	51 kΩ	HF45 7510	HF45 7510
68 Ω	HF45 4680	HF45 4680	56 kΩ	HF45 7560	HF45 7560
75 Ω	HF45 4750	HF45 4750	62 kΩ	HF45 7620	HF45 7620
82 Ω	HF45 4820	HF45 4820	68 kΩ	HF45 7680	HF45 7680
91 Ω	HF45 4910	HF45 4910	82 kΩ	HF45 7820	HF45 7820
100 Ω	HF45 5100	HF45 5100	91 kΩ	HF45 7910	HF45 7910
110 Ω	HJ35 5110	HF85 5110	100 kΩ	HF45 8100	HF45 8100
120 Ω	HF45 5120	HF45 5120	110 kΩ	HF45 8110	HF45 8110
150 Ω	HF45 5150	HF45 5150	120 kΩ	HF45 8120	HF45 8120
160 Ω	HJ35 5160	*	150 kΩ	HF45 8150	HF45 8150
180 Ω	HF45 5180	HF45 5180	180 kΩ	HF45 8180	HF45 8180
200 Ω	HF45 5200	HF45 5200	220 kΩ	HJ35 8220	HF85 8220
220 Ω	HF45 5220	HF45 5220	270 kΩ	HF45 8270	HF45 8270
270 Ω	HF45 5270	HF45 5270	300 kΩ	HF45 8300	HF45 8300
330 Ω	HF45 5330	HF45 5330	330 kΩ	HF45 8330	HF45 8330
390 Ω	HF45 5390	HF45 5390	390 kΩ	HJ35 8390	HF85 8390
430 Ω	HF45 5430	HF45 5430	470 kΩ	HF45 8470	HF45 8470
470 Ω	HF45 5470	HF45 5470	560 kΩ	HJ35 8560	HF85 8560
510 Ω	HF45 5510	HF45 5510	680 kΩ	HJ35 8680	HF85 8680
560 Ω	HF45 5560	HF45 5560	820 kΩ	HJ35 8820	HF85 8820
680 Ω	HF45 5680	HF45 5680	1.0 MΩ	HF45 9100	HF45 9100
820 Ω	HF45 5820	HF45 5820	1.2 MΩ	HJ35 9120	*
910 Ω	HF45 5910	HF45 5910	1.5 MΩ	HJ35 9150	HF85 9150
1.0 k	HF45 6100	HF45 6100	1.8 MΩ	HJ35 9180	HF85 9180
1.2 kΩ	HF45 6120	HF45 6120	2.2 MΩ	HJ35 9220	HF85 9220
1.5 kΩ	HF45 6150	HF45 6150	3.3 MΩ	HJ35 9330	HF85 9330
1.8 kΩ	HF45 6180	HF45 6180	3.9 MΩ	HJ35 9390	*
2.0 kΩ	HJ35 6200	HF85 6200	4.7 MΩ	HJ35 9470	HF85 9470
2.2 kΩ	HF45 6220	HF45 6220			
2.4 kΩ	HJ35 6240	HF85 6240			
2.7 kΩ	HF45 6270	HF45 6270			
3.0 kΩ	HF45 6300	HF45 6300			
3.3 kΩ	HF45 6330	HF45 6330			
3.6 kΩ	HJ35 6360	HF85 6360			
3.9 kΩ	HF45 6390	HF45 6390			
4.7 kΩ	HF45 6470	HF45 6470			
5.1 kΩ	HF45 6510	HF45 6510			
5.6 kΩ	HF45 6560	HF45 6560			
6.8 kΩ	HF45 6680	HF45 6680			
8.2 kΩ	HF45 6820	HF45 6820			
9.1 kΩ	HF45 6910	HF45 6910			
10 kΩ	HF45 7100	HF45 7100			

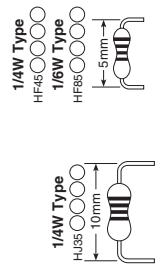

P.C.B. CONNECT

Ref No.	Part No.	Description	Remarks	Markets	部 品 名	ランク
Q062	W0520200	TR. DGT		UC	デジタルトランジスタ	01
R926	V0224200	R. MTL. FLIM		U	金属被覆抵抗	01
S1900	V4040500	SCR. TERM M3	0.47 Ω 1W	U	スクリューターミナル	01
S1950	V4040500	SCR. TERM M3		UC	スクリューターミナル	01

* : New Parts * 新部品

* : Not available

• OVERALL ASSY

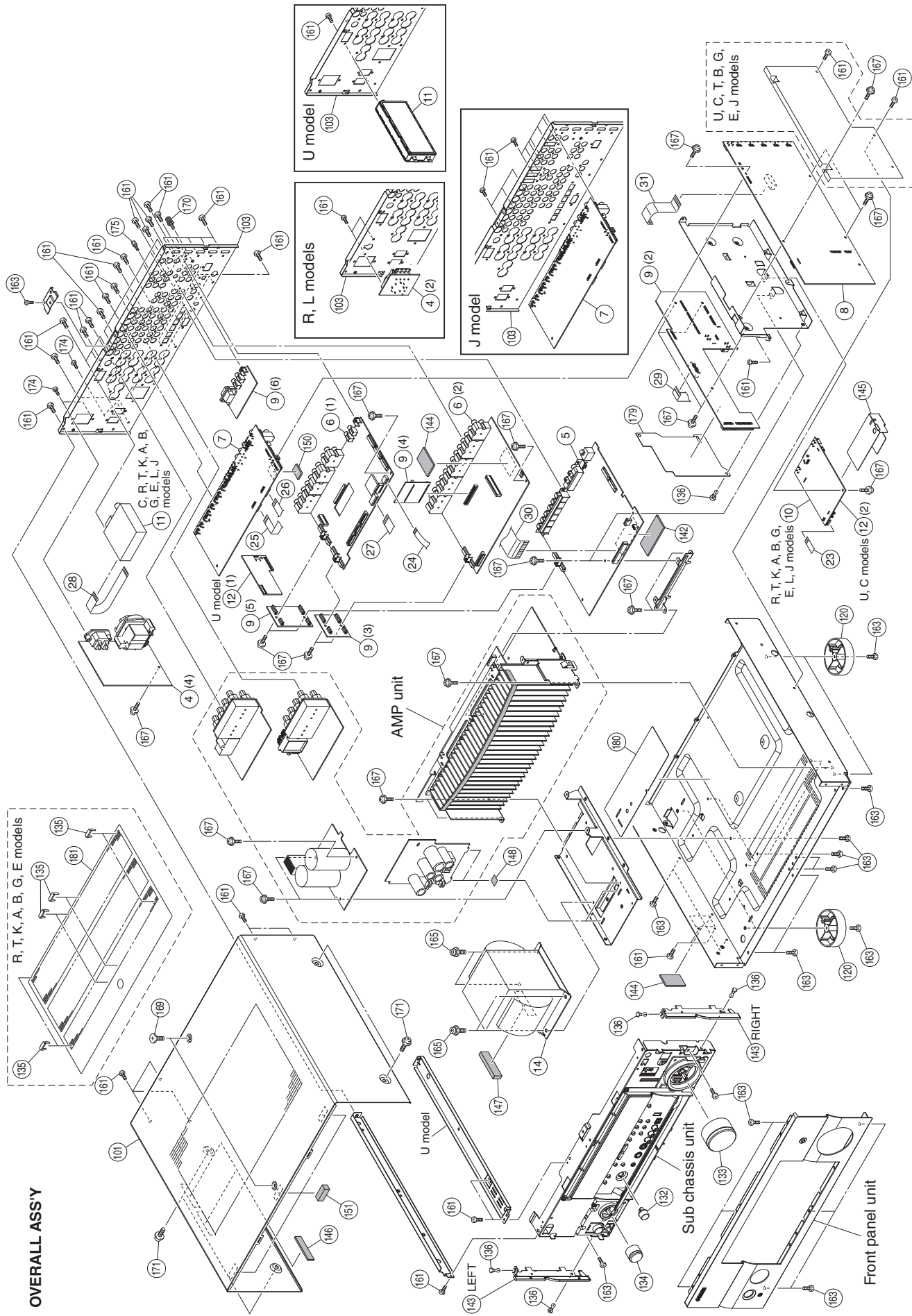

Ref No.	Part No.	Description	Remarks	Markets	部 品 名	ランク
* Δ 4	WP416600	P.C.B. ASS.Y		J	PCB POWER	
* Δ 4	WP416700	P.C.B. ASS.Y		UC	PCB POWER	
* Δ 4	WP416800	P.C.B. ASS.Y		R	PCB POWER	
* Δ 4	WP416900	P.C.B. ASS.Y		T	PCB POWER	
* Δ 4	WP417000	P.C.B. ASS.Y		K	PCB POWER	
* Δ 4	WP417100	P.C.B. ASS.Y		A	PCB POWER	
* Δ 4	WP417200	P.C.B. ASS.Y		B	PCB POWER	
* Δ 4	WP417300	P.C.B. ASS.Y		6E	PCB POWER	
* Δ 4	WP417400	P.C.B. ASS.Y		L	PCB POWER	
* Δ 4	WK647900	P.C.B. ASS.Y		JRTKABEL	PCB DSP	
* 5	WK648000	P.C.B. ASS.Y		UC	PCB DSP	
* 6	WP408900	P.C.B. ASS.Y		J	PCB FUNCTION	
* 6	WP409000	P.C.B. ASS.Y		U	PCB FUNCTION	
* 6	WP409100	P.C.B. ASS.Y	1900	C	PCB FUNCTION	
* 6	WP410000	P.C.B. ASS.Y	6290	C	PCB FUNCTION	
* 6	WP409200	P.C.B. ASS.Y		R	PCB FUNCTION	
* 6	WP409300	P.C.B. ASS.Y		T	PCB FUNCTION	
* 6	WP409400	P.C.B. ASS.Y		K	PCB FUNCTION	
* 6	WP409500	P.C.B. ASS.Y		A	PCB FUNCTION	
* 6	WP409600	P.C.B. ASS.Y	1900	6GE	PCB FUNCTION	
* 6	WP410100	P.C.B. ASS.Y	6290	G	PCB FUNCTION	
* 6	WP409700	P.C.B. ASS.Y		L	PCB FUNCTION	
* 6	WP409800	P.C.B. ASS.Y		J	PCB FUNCTION	
* 7	WH565200	P.C.B. ASS.Y		UC	PCB AVIDEO	23
* 7	WH565300	P.C.B. ASS.Y		UC	PCB AVIDEO	
* 7	WH565400	P.C.B. ASS.Y		RK	PCB AVIDEO	
* 7	WH565500	P.C.B. ASS.Y		TABGEL	PCB AVIDEO	
* 8	WK647200	P.C.B. ASS.Y		J	PCB AVIDEO	
* 8	WP408600	P.C.B. ASS.Y		J	PCB FL	
* 8	WP408700	P.C.B. ASS.Y		J	PCB FL	
* 9	WP410800	P.C.B. ASS.Y		JRTKABEL	PCB NET	
* 10	WD048200	AM/FM TUNER		J	AM/FMチューナー	
* 11	WD048300	HD RADIO TUNER		U	HDチューナー	
* 11	WD048400	AM/FM TUNER	F3E385-J01F	GRTL	AM/FMチューナー	
* 11	WD048500	AM/FM TUNER	F3E385-A01F	K486E	AM/FMチューナー	
* 12	WP155800	P.C.B. ASS.Y	F3E485-E01F	U	PCB CONNECT	
* 12	WP155900	P.C.B. ASS.Y	CONNECT	C	PCB CONNECT	
* Δ 14	X8053300	POWER TRANSFORMER		J	電源トランス	
* Δ 14	X8054400	POWER TRANSFORMER		UC	電源トランス	
* Δ 14	X8055400	POWER TRANSFORMER		RL	電源トランス	
* Δ 14	X8056400	POWER TRANSFORMER		TK	電源トランス	
* Δ 14	X8057400	POWER TRANSFORMER		A	電源トランス	
* Δ 14	X8058400	POWER TRANSFORMER		6GE	電源トランス	
* 23	WP504300	FLEXIBLE FLAT CABLE	6P 180mm P=1.25		カード電線	
* 24	WP504400	FLEXIBLE FLAT CABLE	7P 70mm P=1.25		カード電線	
* 25	WP504500	FLEXIBLE FLAT CABLE	10P 350mm P=1.25		カード電線	
* 26	WP504600	FLEXIBLE FLAT CABLE	11P 70mm P=1.25		カード電線	
* 27	WP505100	FLEXIBLE FLAT CABLE	14P 100mm P=1.25		カード電線	
* 28	WI181500	FLEXIBLE FLAT CABLE	15P 140mm P=1.25		カード電線	
* 29	WI181500	FLEXIBLE FLAT CABLE	18P 140mm P=1.0		カード電線	
* 30	WP506100	FLEXIBLE FLAT CABLE	31P 180mm P=1.25		カード電線	
* 31	WP510700	FLEXIBLE FLAT CABLE	20P 100mm P=1.0		カード電線	
* 101	WH193000	TOP COVER			トップカバー	
* 101	WH192900	TOP COVER			トップカバー	
* 101	WH193100	TOP COVER			トップカバー	
* 103	WN999500	REAR PANEL		J	リアパネル	

* New Parts * 新部品

Ref No.	Part No.	Description	Remarks	Markets	部 品 名	ランク
* 103	WN998700	REAR PANEL		U	リアパネル	
* 103	WN998800	REAR PANEL	1900	C	リアパネル	
* 103	WN999700	REAR PANEL	6290	C	リアパネル	
* 103	WN998900	REAR PANEL		R	リアパネル	
* 103	WN999000	REAR PANEL		T	リアパネル	
* 103	WN991100	REAR PANEL		K	リアパネル	
* 103	WN999200	REAR PANEL		A	リアパネル	
* 103	WN999300	REAR PANEL	1900	B	リアパネル	
* 103	WN999400	REAR PANEL	6290	6E	リアパネル	
* 103	WN999600	REAR PANEL		G	リアパネル	
* 120	V0042500	LEG	D60XH21 GD	L	リアパネル	03
* 120	VS025000	LEG	D60XH21 HS		レッグ	02
* 132	WF060100	KNOB D15	PROGRAM	GD	ノブD15	01
* 132	WF060000	KNOB D15	PROGRAM	GD	ノブD15	01
* 132	WF060200	KNOB D15	PROGRAM	GD	ノブD15	01
* 133	WN992000	KNOB D48	VOLUME	TI	ノブD48	
* 133	WN991900	KNOB D48	VOLUME	GD	ノブD48	
* 133	WN992100	KNOB D48	VOLUME	BL	ノブD48	
* 134	WN992800	KNOB D24	VOLUME	TI	ノブD24	
* 134	WN992700	KNOB D24	INPUT	GD	ノブD24	
* 134	WN992900	KNOB D24	INPUT	BL	ノブD24	
* 135	WL053800	RIVET TOP	INPUT	TI	ノブD24	
* 136	V0368600	PUSH RIVET	P3555-B	RTKABGE	リベットトップ	01
* 142	V6742300	DAMPER	3x30x60		ダンパー	02
* 143	WD046500	PLATE SIDE		GD	プレートサイド	01
* 143	WD046400	PLATE SIDE		BL	プレートサイド	
* 143	WD046600	PLATE SIDE		TI	プレートサイド	
* 144	V9597500	DAMPER BASE	36x20x3		ダンパー ベース	01
* 145	WL046400	BARRIER NET		JRTKABEL	ダンパー ネット	01
* 146	VZ117100	DAMPER T2	50x10x2		ダンパー T 2	01
* 147	WL068300	DAMPER TRANS	55x15x5		ダンパー トランス	04
* 148	V6080600	CUSHION	10x20x3		クッション	01
* 150	WE812900	DAMPER	18x12 T=2		ダンパー	01
* 151	V7716700	DAMPER	5x5x15		ダンパー	01
* 161	WE774100	BIND HEAD BONDING B-T. SCREW	MFZN2B3		ボンディングBタイトネジ	01
* 163	WE936300	BIND HEAD B-TIGHT SCREW	MFZN2W3		タイトネジ	01
* 165	WE774700	BIND HEAD S-TIGHT SCREW	MFZN2W3		タイトネジ	01
* 167	WF002600	PW HEAD B-TIGHT SCREW	4x10		PWヘッドタイトネジ	01
* 169	VZ2893000	SPECIAL S-TIGHT SCREW	3x8	GD, TI	PWヘッドタイトネジ	01
* 169	WE527100	SPECIAL S-TIGHT SCREW	4x8-10	BL	化繊ネジタイト	02
* 170	AA627310	GROUND TERMINAL	4x8-10		化繊ネジタイト	01
* 171	VD089600	PW HEAD S-TIGHT SCREW	4x8-10	GD, TI	GNDターミナル	01
* 171	WH313200	PW HEAD S-TIGHT SCREW	4x8-10	BL	PWヘッドタイトネジ	01
* 174	WE774800	BIND HEAD P-TIGHT SCREW	3x8		PWヘッドタイトネジ	01
* 175	V6509600	JACK SCREW	SS6-AA7511848		ジャックPタイトネジ	01
* 179	WL091400	BARRIER FFC			ジャックFFC	02
* 180	WL0462000	SHEET BARRIER			シートバリアー	01
* 181	WL053900	SHEET TOP		RTKABGE	シートトップ	01

* New Parts * 新部品

RX-V1900/HTR-6290/DSP-AX1900

ACCESSORIES

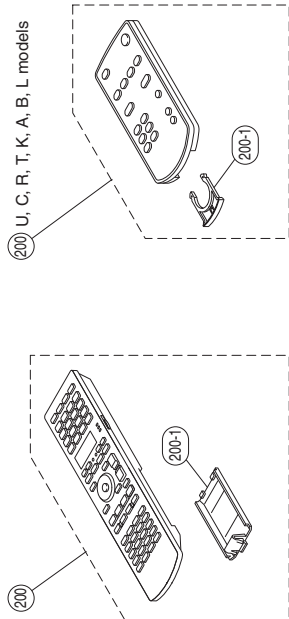

202 U, C, R, T, L, J models
203 K, A, B, G, E models
204 C, R, T, K, A, B, G, E, L, J models

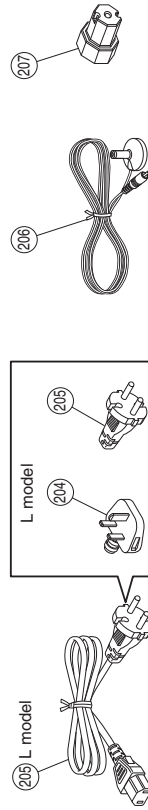
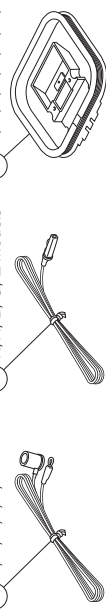

Ref No.	Part No.	Description	Remarks	Markets	部 品 名	ランク
		ACCESSORIES			付属品	
200	WN983800	REMOTE CONTROL	RAV384	J	リモコン	
200	WN983700	REMOTE CONTROL	RAV383	UC	リモコン	
200	WN983900	REMOTE CONTROL	RAV385	RTKABEL	リモコン	
200-1	AA90660	BATTERY COVER			電池蓋	
201	WPR75800	SIMPLIFIED REMOTE CONTROL	RAV37	UCRTKABL	簡易リモコン	03
201-1	AA71770	BATTERY HOLDER	CG-4335 B lack	UCRTKABL	F M簡易アンテナ	02
202	V6267000	INDOOR FM ANTENNA	1.4m 1pc	JUCRTL	F M簡易アンテナ	03
202	VQ147100	INDOOR FM ANTENNA	1.4m 1pc	KABBE	F M簡易アンテナ	
203	WR248500	AM LOOP ANTENNA	1.0m 1pc	JCRTKABEL	A Mループアンテナ	
203	WE746800	AM LOOP ANTENNA	1.2m 1pc	U	A Mループアンテナ	
204	WQ292100	POWER CABLE	2m 1pc	J	電源コード	05
204	V7704800	POWER CABLE	2m 1pc	UC	電源コード	
204	WK391000	POWER CABLE	2m 1pc	R	電源コード	05
204	V9358400	POWER CABLE	2m 1pc	T	電源コード	
204	WH641300	POWER CABLE	2m 1pc	K	電源コード	07
204	WB750900	POWER CABLE	2m 1pc	A	電源コード	
204	WG577000	POWER CABLE	2m 1pc	BL	電源コード	06
204	V7704900	POWER CABLE	2m 1pc	GE	電源コード	06
205	V7704900	POWER CABLE	2m 1pc	L	電源コード	08
206	WB929200	OPTIMIZER MICROPHONE	6m 1pc		オプティマイザーマイク	
207	WC080100	SPEAKER TERMINAL WRENCH	1pc		S Pターミナルレンチ	01
		BATTERY	RO3, AAA, UM=4 4pcs CR2025		単4乾電池 リチウム電池	
		LITHIUM BATTERY				
		SERVICE TOOLS			サービスマニュアル	
	MF405400	CRIMPING ASS'Y	5P 400mm B to C		圧着 ASSY	03
	MF408250	CRIMPING ASS'Y	8P 250mm B to C		圧着 ASSY	09
	MF115500	FLEXIBLE FLAT CABLE	15P 500mm P=1.25		カード電線 C&C	
	MF131500	FLEXIBLE FLAT CABLE	31P 500mm P=1.25		カード電線 C&C	03
	MF111350	FLEXIBLE FLAT CABLE	11P 350mm P=1.25		カード電線 C&C	03
	MF118400	FLEXIBLE FLAT CABLE	18P 400mm P=1.0		カード電線 C&C	02
	MF20250	FLEXIBLE FLAT CABLE	20P 250mm P=1.0		カード電線 C&C	
	MF126500	FLEXIBLE FLAT CABLE	26P 500mm P=1.25		カード電線 C&C	
	MF114400	FLEXIBLE FLAT CABLE	14P 400mm P=1.25		カード電線 C&C	

*: New Parts * 新部品

• FRONT PANEL and SUB CHASSIS UNIT

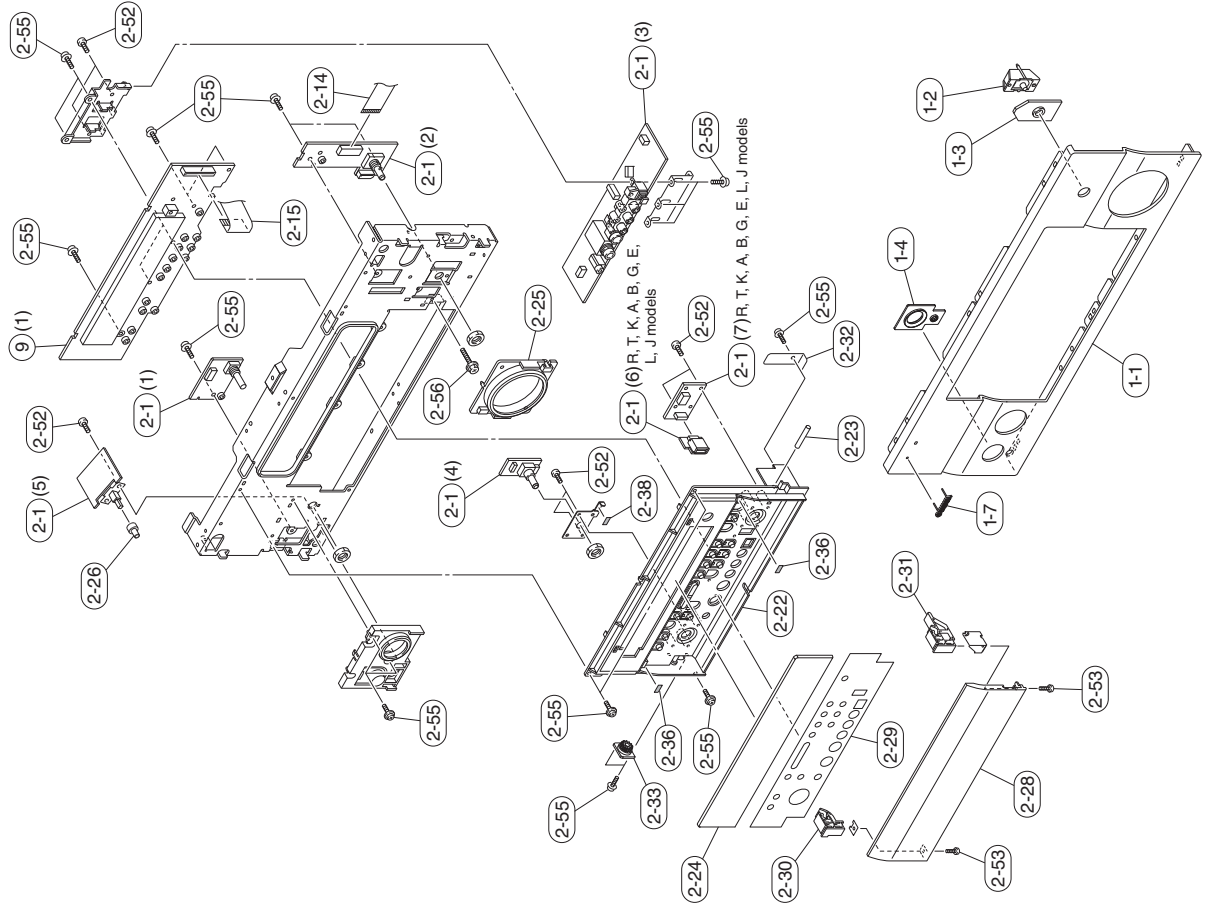

Ref No.	Part No.	Description	Remarks	Markets	部 品 名	ランク
1-1	WP000500	FRONT PANEL	GD	J	フロントパネル	
1-1	WP000400	FRONT PANEL	GD	RTK	フロントパネル	
1-1	WP000300	FRONT PANEL	1900BL		フロントパネル	
1-1	WP000700	FRONT PANEL	6290BL		フロントパネル	
1-1	WP000600	FRONT PANEL	TI		フロントパネル	01
1-2	WF121100	BUTTON LENS	GD		ボタン/レンズ	06
1-3	WH186000	ESCUTCHEON D5	BL		エスカッションD5	06
1-3	WH185800	ESCUTCHEON D5	TI		エスカッションD5	
1-3	WH186100	ESCUTCHEON D5	TI		エスカッションD5	
1-4	WH384900	ESCUTCHEON PJ	GD		エスカッションP	01
1-4	WH384800	ESCUTCHEON PJ	BL		エスカッションP	
1-4	WH385000	ESCUTCHEON PJ	TI		エスカッションP	
1-7	V6034200	EMBLEM	GD		エンブレム	03
1-7	V6034100	EMBLEM	BL, TI		エンブレム	03
2-1	WH567400	P.C.B. ASS Y	OPERATION	J	P.C.B オペレーション	12
2-1	WH567300	P.C.B. ASS Y	OPERATION	UC	P.C.B オペレーション	
2-1	WH567500	P.C.B. ASS Y	OPERATION	RTABGEL	P.C.B オペレーション	
2-14	WP005200	FLEXIBLE FLAT CABLE	OPERATION		カード電線	
2-15	W0087300	FLEXIBLE FLAT CABLE	TSP 140mm P=1.25		カード電線	
2-21	V6007000	SHEET FL	Z6P 100mm P=1.25		シートFL	03
2-22	WK499100	SUB PANEL	GD	J	サブパネル	07
2-22	WK499000	SUB PANEL	GD	RTK	サブパネル	
2-22	WK498900	SUB PANEL	BL		サブパネル	
2-22	WK499200	SUB PANEL	TI		サブパネル	
2-23	V9126500	SHAFT			シャフト	01
2-23	WF649700	SUPPORT FL			サポートFL	01
2-24	WH996900	WINDOW PANEL LID	GD	J	ウィンドウ	
2-25	WH997900	ESCUTCHEON VI	GD	RTK	エスカッションVI	
2-25	WH997800	ESCUTCHEON VI	BL		エスカッションVI	
2-25	WH997700	ESCUTCHEON VI	TI		エスカッションVI	
2-26	WH998000	ESCUTCHEON VI	GD		エスカッションVI	01
2-26	V6002000	BUTTON D5	GD		ボタン D5	01
2-26	V6001900	BUTTON D5	BL		ボタン D5	
2-26	WG290000	BUTTON D5	TI		ボタン D5	
2-28	WP001200	PANEL LID	GD	J	パネルリッド	
2-28	WP001100	PANEL LID	GD	RTK	パネルリッド	
2-28	WP000800	PANEL LID	BL	U	パネルリッド	
2-28	WP391800	PANEL LID	BL	C	パネルリッド	
2-28	WP001300	PANEL LID	BL	RTABGEL	パネルリッド	
2-29	WP002800	PLATE SP	GD	J	プレートSP	
2-29	WP002700	PLATE SP	GD	RTK	プレートSP	
2-29	WP002400	PLATE SP	BL	UC	プレートSP	
2-29	WP002500	PLATE SP	BL	RTABGEL	プレートSP	
2-30	W0432100	HINGE L	TI		プレートSP	
2-30	W0432000	HINGE L	GD		プレートSP	
2-30	W0432200	HINGE L	BL		プレートSP	
2-31	V6005400	HINGE R	TI		ヒンジL	
2-31	V6005300	HINGE R	GD		ヒンジL	
2-31	V6005500	HINGE R	BL		ヒンジL	
2-32	V4593300	SPRING LID			ヒンジR	01
2-33	V9124600	DAMPER GEAR			スプリングリッド	03
2-36	W0144500	CUSHION	t=0.8		ダンパーギヤ	01
2-36	WE774800	BIND HEAD P-TIGHT SCREW	5x10		クッションLID	
2-52	WH973700	BIND HEAD P-TIGHT SCREW	3x8		クッション	01
2-55	WH959600	PW HEAD TAPPING B-T. SCREW	2.6x6		ハイントタイトネジ	01
2-55	WH959500	PW HEAD TAPPING B-T. SCREW	3x6-8		ハイントタイトネジ	01
2-56	WH220800	HEXAGONAL HEAD B-TIGHT SCREW	3x15 SP		PWヘッドタイトネジ	01
2-56	WH220800	HEXAGONAL HEAD B-TIGHT SCREW	3x15 SP		6角タイトネジ	01

* New Parts * 新規部品

• AMP UNIT

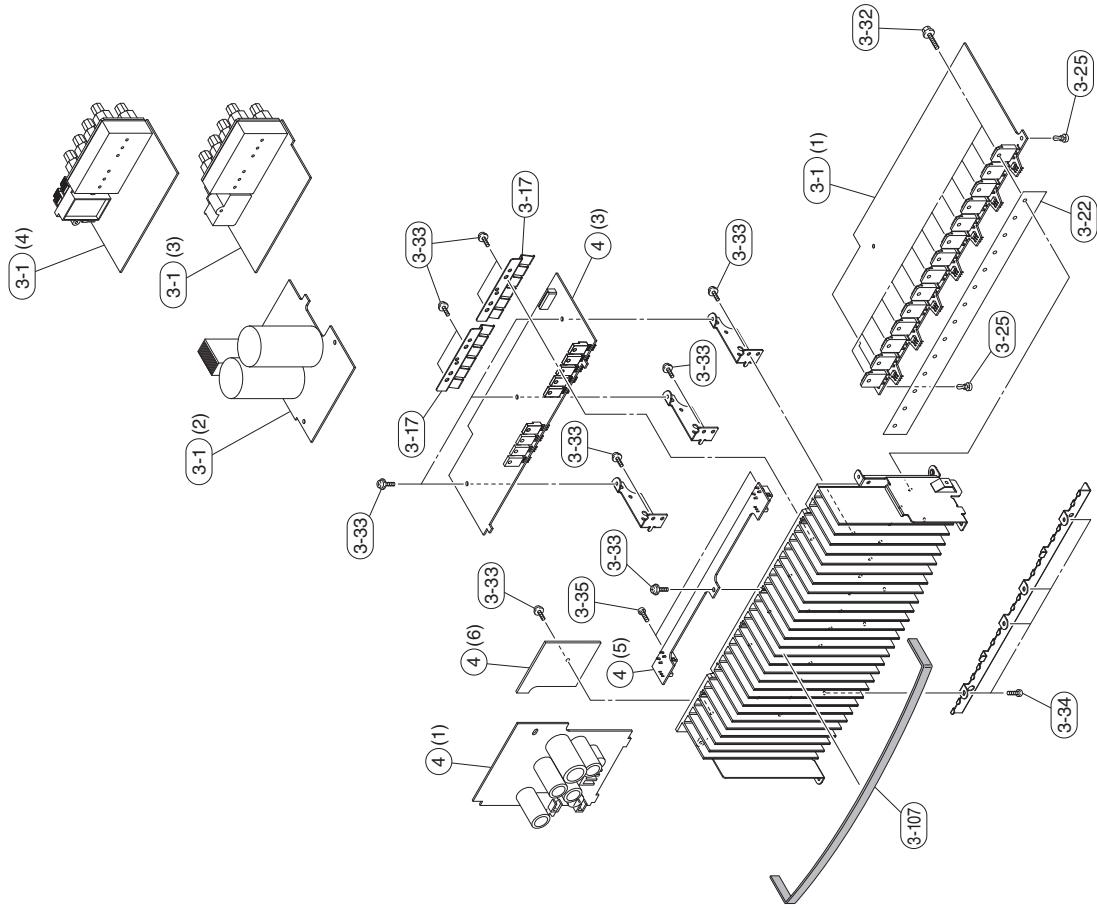

Ref No.	Part No.	Description	Remarks	Markets	部 品 名	ランク
* 9	WP408600	P.C.B. ASS'Y		J	PCB FL	
* 9	WP408700	P.C.B. ASS'Y		UCRTKABGEL	PCB FL	
* Δ 3-1	WP410200	P.C.B. ASS'Y		J	PCB MAIN	
* Δ 3-1	WP410300	P.C.B. ASS'Y		UC	PCB MAIN	
* Δ 3-1	WP410400	P.C.B. ASS'Y		RTA	PCB MAIN	
* Δ 3-1	WP410500	P.C.B. ASS'Y		KBGEL	PCB MAIN	
* 3-17	WG432400	SUPPORT TR-6			サポート TR-6	03
* 3-22	WP952300	RADIATION SHEET			放射シート	
3-25	VG368600	PUSH RIVET	TC-20EG 295x24.5x0.2		プッシュリベット	01
3-32	MM220800	HEXAGONAL HEAD B-TIGHT SCREW 3x15 SP	P3555-B		六角Bタイトネジ	01
3-33	WF002600	PW HEAD B-TIGHT SCREW 3x8	MFZ1Z1W3		PWヘッドBタイトネジ	01
3-34	WE774100	BIND HEAD BONDING B-T. SCREW 3x8	MFZ1Z1W3		ボンディングBタイトネジ	01
3-35	WE936300	BIND HEAD B-TIGHT SCREW 3x6	MFZ1Z1W3		バインドBタイトネジ	01
3-107	NC879400	DAMPER 360x10 t=1			ダンパー	
* Δ 4	WP416600	P.C.B. ASS'Y		J	PCB POWER	
* Δ 4	WP416700	P.C.B. ASS'Y		UC	PCB POWER	
* Δ 4	WP416800	P.C.B. ASS'Y		R	PCB POWER	
* Δ 4	WP416900	P.C.B. ASS'Y		T	PCB POWER	
* Δ 4	WP417000	P.C.B. ASS'Y		K	PCB POWER	
* Δ 4	WP417100	P.C.B. ASS'Y		A	PCB POWER	
* Δ 4	WP417200	P.C.B. ASS'Y		B	PCB POWER	
* Δ 4	WP417300	P.C.B. ASS'Y		GE	PCB POWER	
* Δ 4	WP417400	P.C.B. ASS'Y		L	PCB POWER	

*: New Parts * 新部品

REMOTE CONTROL

- RAV383 (RX-V1900: U, C models / HTR-6290: C model), RAV385 (RX-V1900: R, T, K, A, B, E, L models / HTR-6290: G model), RAV384 (DSP-AX1900: J model) SCHEMATIC DIAGRAMS 1/2

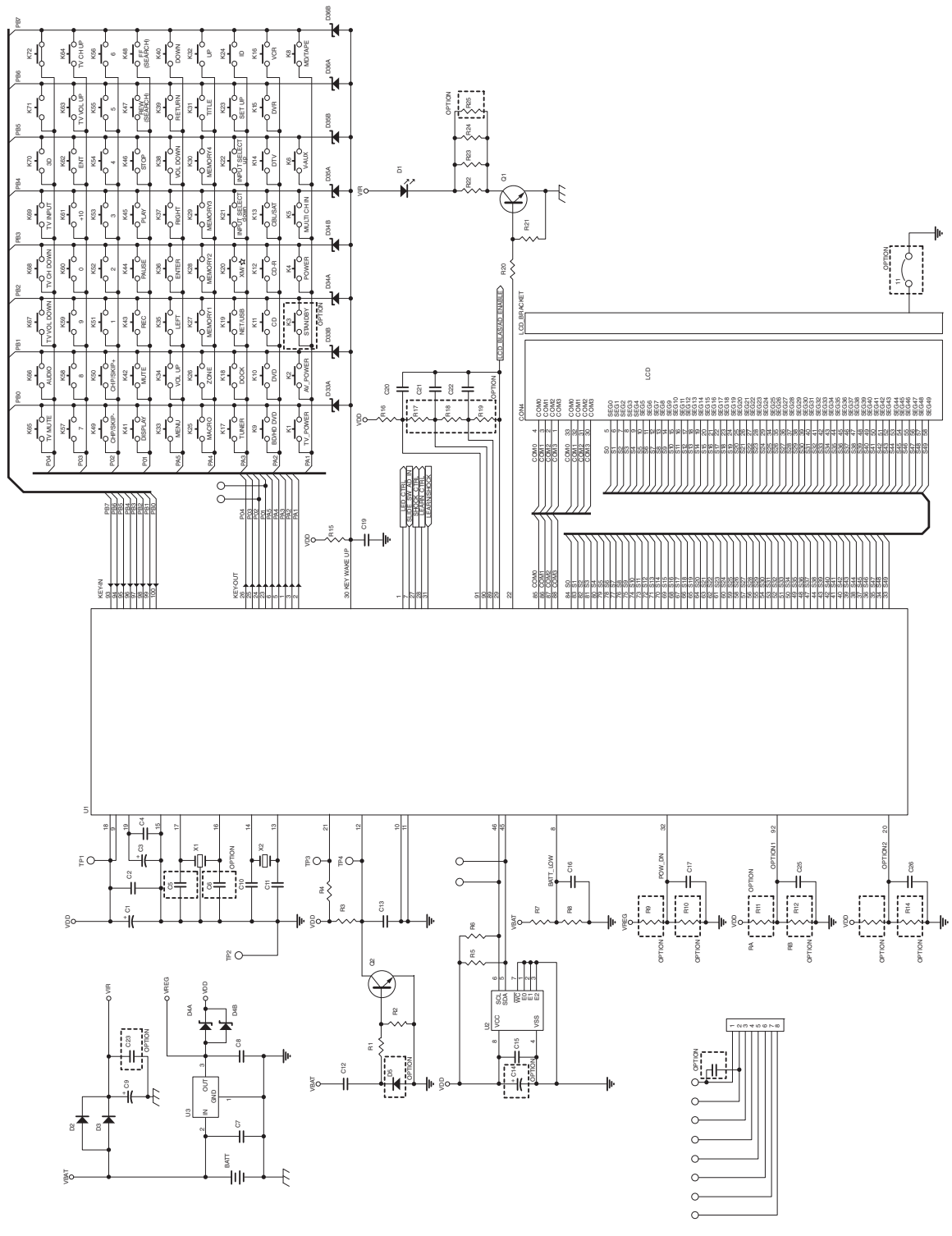

SCHEMATIC DIAGRAMS 2/2

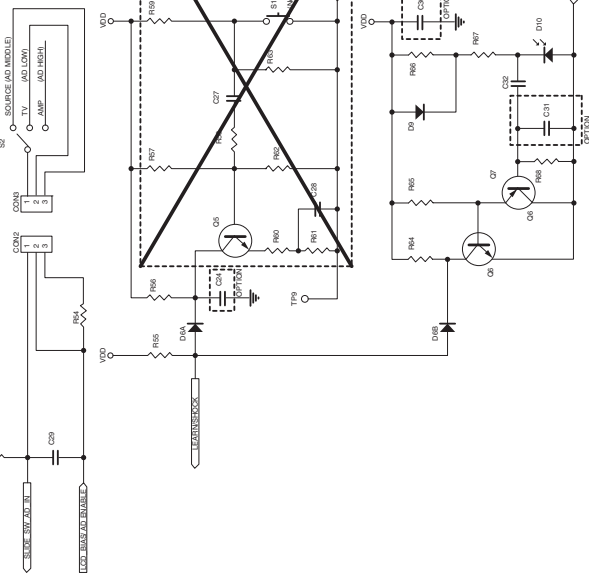
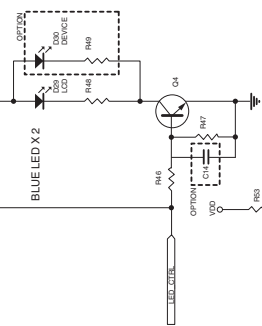
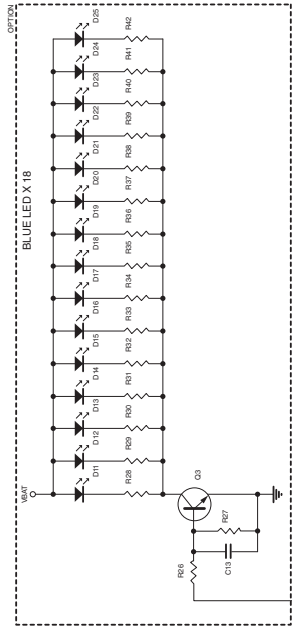

PANELS

RAV383
RX-V1900
(U, C models)
HTR-6290
(C model)

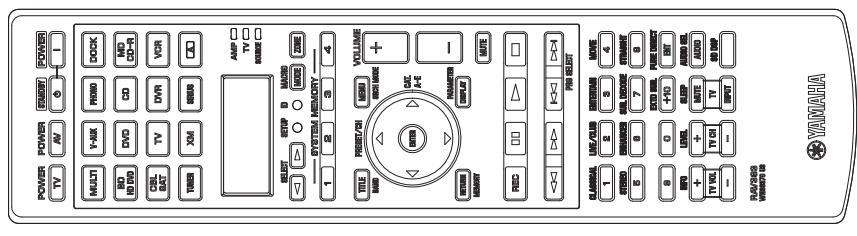

RAV385
RX-V1900
(R, T, K, A, B, G, E, L models)
HTR-6290
(G model)

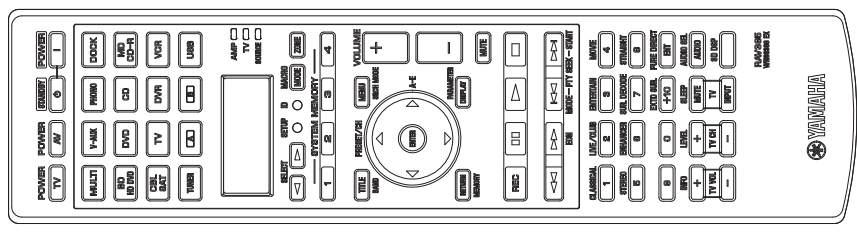

RAV384
DSP-AX1900
(J model)

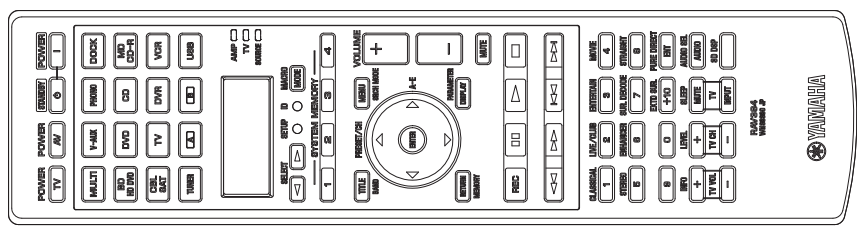

● RAV37 (RX-V1900: U, C, R, T, K, A, B, L models / HTR-6290: C model) SCHEMATIC DIAGRAMS

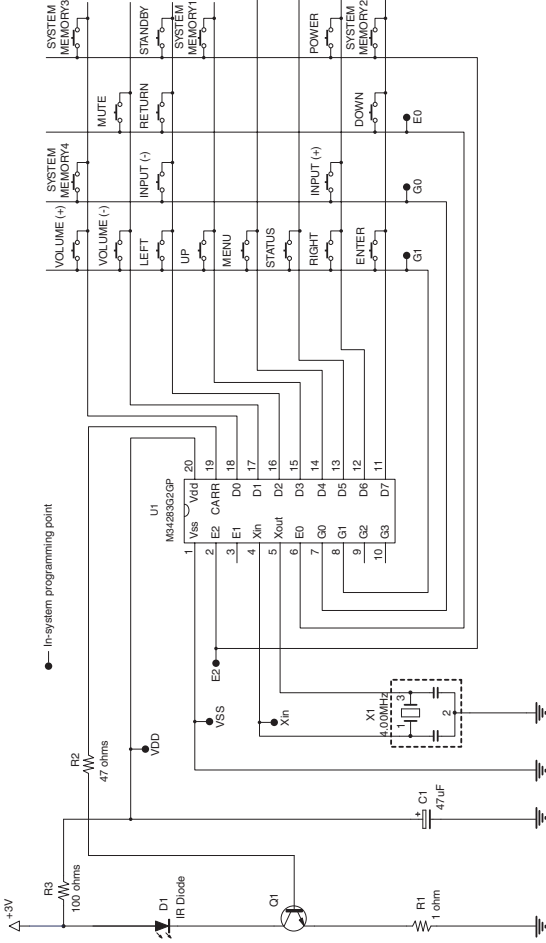

PANEL

RAV37

RX-V1900 (U, C, R, T, K, A, B, L models)
HTR-6290 (C model)

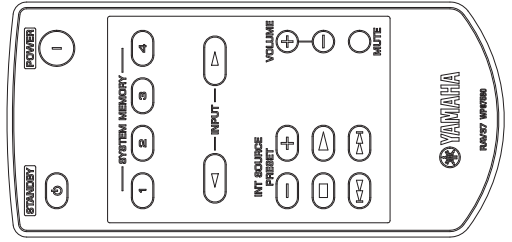

KEY NO. LAYOUT

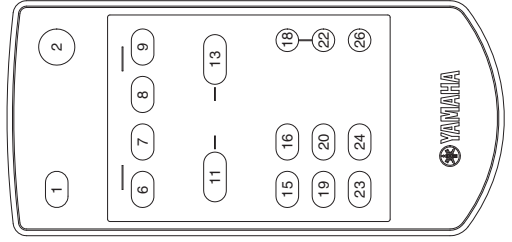

KEY CODE

Key no.	Function	Custom code											
		ID1			ID2			ID3					
		MAIN	ZONE2	ZONE3	ZONE4	MAIN	ZONE2	ZONE3	ZONE4	MAIN	ZONE2	ZONE3	ZONE4
1	STANDBY	7E-7F	7E-BB	7A-EE	7A-7C	7D-B1	7D-63	7D-73	7A-7C82				
2	POWER	7E-7E	7E-BA	7A-ED	7A-7B	7D-B2	7D-64	7D-74	7A-7B85				
6	SYSTEM MEMORY 1	7A-007F	7A-017E	7A-027D	7A-1867	7A-007E	7A-017F	7A-027C	7A-1866				
7	SYSTEM MEMORY 2	7A-037C	7A-047B	7A-057A	7A-1866	7A-037D	7A-047A	7A-057B	7A-1867				
8	SYSTEM MEMORY 3	7A-0679	7A-0778	7A-0877	7A-1A65	7A-0678	7A-0779	7A-0876	7A-1A64				
9	SYSTEM MEMORY 4	7A-0976	7A-0A75	7A-0B74	7A-1B64	7A-0977	7A-0A74	7A-0B75	7A-1B65				
11	INPUT (-)	7A-235C	7A-245B	7A-255A	7A-235D	7A-245A	7A-255B	7A-2658					
13	INPUT (+)	7A-1F60	7A-205F	7A-215E	7A-225D	7A-1F61	7A-205E	7A-215F	7A-225C				
15	PRESET (▼)	7F01-027D	7F01-037C	7F01-047B	7F01-057A	7F01-027C	7F01-037D	7F01-047A	7F01-057B				
16	PRESET (▲)	7F01-0679	7F01-0778	7F01-0877	7F01-0976	7F01-0678	7F01-0779	7F01-0876	7F01-0977				
18	VOLUME (+)	7A-1A	7A-DA	7A-FA	7A-2B	7D-8D	7D-70	7D-20	7A-2B05				
19	STOP	7F01-69	7F01-89	7F01-A9	7F01-C9	7F01-6977	7F01-8977	7F01-A957	7F01-C937				
20	PLAY	7F01-68	7F01-88	7F01-A8	7F01-C8	7F01-6896	7F01-8896	7F01-A856	7F01-C836				
22	VOLUME (-)	7A-1B	7F01-6B	7F01-8B	7A-2C	7D-8E	7D-71	7D-21	7A-2C02				
23	SKIP (-)	7F01-6C	7F01-8C	7F01-AC	7F01-CC	7F01-6C92	7F01-8C72	7F01-AC52	7F01-CC32				
24	SKIP (+)	7F01-6D	7F01-8D	7F01-AD	7F01-CD	7F01-6D93	7F01-8D73	7F01-AD53	7F01-CD33				
26	MUTE	7A-1C	7A-DC	7A-FC	7A-2D	7D-94	7D-72	7D-22	7A-2D03				
				[K23] + [K6]				[K23] + [K7]					
				= ID1				= ID2					
	ZONE setting	[K24] + [K6]	[K24] + [K7]	[K24] + [K8]	[K24] + [K9]	[K24] + [K6]	[K24] + [K7]	[K24] + [K8]	[K24] + [K9]	[K24] + [K6]	[K24] + [K7]	[K24] + [K8]	[K24] + [K9]
		= MAIN	= ZONE2	= ZONE3	= ZONE4	= MAIN	= ZONE2	= ZONE3	= ZONE4	= MAIN	= ZONE2	= ZONE3	= ZONE4
		Default: ID1/MAIN											

Advanced setup

This unit has additional menus that are displayed in the front panel display. The advanced setup menu offers additional operations to adjust and customize the way this unit operates. Change the initial settings (indicated in bold under each parameter) to reflect the needs of your listening environment.

Notes

- Only **A** MASTER ON/OFF, **C** STRAIGHT and the **N** PROGRAM selector are effective while you are using the advanced setup menu.
- All the other operations cannot be made while you are using the advanced setup menu.
- The advanced setup menu is only available in the front panel display.

Using the advanced setup menu

- 1 Press **A** MASTER ON/OFF on the front panel to release it outward to the OFF position to turn off this unit.**
- 2 Press and hold **C** STRAIGHT and then press **A** MASTER ON/OFF inward to the ON position to turn on this unit.**
This unit turns on, and “ADVANCED SETUP” appears in the front panel display.



- 3 Rotate the **N** PROGRAM selector to select the parameter you want to adjust.**
- 4 Press **C** STRAIGHT repeatedly to change the selected parameter setting.**
- 5 Press **A** MASTER ON/OFF to release it outward to the OFF position to save the new setting and turn off this unit.**

The settings you made are reflected next time you turn on this unit.

■ Speaker impedance **SPEAKER IMP.**
Use this feature to set the speaker impedance of this unit so that it matches that of your speakers.

Choice	Descriptions
8ΩMIN	Select this setting to set the speaker impedance to 8 Ω. The impedance of each speaker must be 8 Ω or higher.
6ΩMIN	Select this setting to set the speaker impedance to 6 Ω. The impedance of each speaker must be 6 Ω or higher (front speakers only: 4 Ω or higher).

■ Remote sensor **REMOTE SENSOR**
Use this feature to activate or deactivate the signal-receiving capability of the remote control sensor on the front panel of this unit.

Choice	Descriptions
ON	Select this setting if you want to activate the signal-receiving capability of the remote control sensor.
OFF	Select this setting if you want to deactivate the signal-receiving capability of the remote control sensor.

Note
We recommend setting the parameter to “ON” in most cases.

■ Wake on RS-232C access **RS-232C STANDBY**
Use this feature to set this unit to transmit data via the RS-232C interface when this unit is in the standby mode.

Choice	Functions
YES	Select this setting to set this unit to transmit data via the RS-232C interface.
NO	Select this setting to set this unit not to transmit data via the RS-232C interface.

Initial setting:
[U.S.A. and Canada models]: YES
[Other models]: NO

■ Remote control ID setting **REMOTE CON AMP**
Use this feature to set the remote control ID of this unit for remote control recognition.

Choice	Descriptions
ID1	Select this setting when the ID of the remote control is set to “ID1”
ID2	Select this setting when the ID of the remote control is set to “ID2”

Setting remote control ID
Use this feature to set the remote control ID. This feature is useful when you control multiple Yamaha AV receiver or amplifier with using the remote control.

Press **ID** repeatedly using a ballpoint pen or similar object on the remote control to select the desired remote control ID.

Each time you press **ID**, the remote control ID indicator changes as shown below.

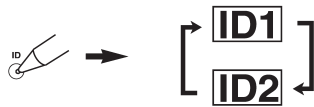

To set the remote control ID of the simplified remote control.

■ **SIRIUS Satellite Radio Parental Lock code number reset** SIRIUS PIN (U.S.A. and Canada models only)

Use this feature to set the code number for the SIRIUS Satellite Radio Parental Lock feature to the initial factory setting.

Choice	Descriptions
RESET	Sets the code number to the initial factory setting.
CANCEL	Cancels the reset of the code number.

■ **Tuner frequency step** TUNER FRQ STEP (Asia and General models only)

Use this feature to set the tuner frequency step according to the frequency spacing in your area.

Choice	Descriptions
AM10/ FM100	Select this setting for North, Central and South America.
AM9/FM50	Select this setting for all other countries.

■ **Bi-amplifier mode** BI-AMP

Use this feature to activate or deactivate the bi-amplifier function.

Choice	Descriptions
ON	Select this setting if you want to activate the bi-amplifier function.
OFF	Select this setting if you want to deactivate the bi-amplifier function.

Note

When "BI-AMP" is set to "ON", the SURROUND BACK terminals cannot be used to connect surround back speakers in that the terminals are already used for the bi-amplifier connection.

■ **Parameter initialization** INITIALIZE

Use this feature to reset the parameters of this unit to the initial factory settings. You can select the category of parameters to be initialized.

Choice	Descriptions
DSP PARAM	Select this setting to initialize all the parameters of the sound field parameters.
VIDEO	Select this setting to initialize all the parameters in "VIDEO MENU" and "OSD SHIFT" and "GRAY BACK" in "DISPLAY SET".
ALL	Select this setting to initialize all the parameters of this unit.
CANCEL	Select this setting to cancel the initialization procedure.



To initialize the parameters of each sound field program, use "INITIALIZE" in the sound field program menu.

■ **HDMI monitor check** MONITOR CHECK

Use this feature to activate or deactivate the monitor check function of this unit.

Choice	Descriptions
YES	This unit receives the information of the available video signal resolutions from the video monitor connected via HDMI and you can only select the resolutions supported by the video monitor in "HDMI RES.".
SKIP	You can select any resolution in "HDMI RES."

Resetting the system

Use this feature to reset all the parameters of this unit to the initial factory settings.

Notes

- This procedure completely resets all the parameters of this unit including the “SET MENU” parameters.
- The initial factory settings are activated next time you turn on this unit.



To cancel the initialization procedure at any time without making any changes, press **Ⓐ MASTER ON/OFF** on the front panel to release it outward to the OFF position.

- 1 Press **Ⓐ MASTER ON/OFF** on the front panel to release it outward to the OFF position to turn off this unit.
- 2 Press and hold **Ⓞ STRAIGHT** and then press **Ⓐ MASTER ON/OFF** inward to the ON position to turn on this unit.
This unit turns on, and “ADVANCED SETUP” appears in the front panel display.



- 3 Rotate the **Ⓝ PROGRAM** selector to select “INITIALIZE”.



- 4 Press **Ⓞ STRAIGHT** repeatedly to select “ALL”.



Select “CANCEL” to cancel the initialization procedure without making any changes.

- 5 Press **Ⓐ MASTER ON/OFF** to release it outward to the OFF position to confirm your selection and turn off this unit.

本機の設定を変更する (ADVANCED SETUP)

フロントパネルディスプレイに表示されるメニューを見ながらさまざまな項目を設定します。アドバンスドセットアップメニューでは、本機の設定を初期設定に戻したりリモコン ID を変更したりすることができます。お好みに合わせて、設定を変更してください。各項目の初期設定は太字で記載しています。

ご注意

- アドバンスドセットアップメニューの操作中は、本体の **MASTER ON/OFF** スイッチ、**STRAIGHT** キー、**PROGRAM** セレクター以外は機能しません。
- アドバンスドセットアップメニューの操作中は他の操作はできません。
- アドバンスドセットアップメニューはフロントパネルディスプレイでのみ操作できます。

アドバンスドセットアップ メニューの操作手順

1 本体の **MASTER ON/OFF** スイッチを押して本機の電源をオフにする。

2 **STRAIGHT** キーを押しながらもう一度 **MASTER ON/OFF** スイッチを押す。
本機の電源がオンになり、アドバンスドセットアップメニューがフロントパネルディスプレイに表示されます。



3 **PROGRAM** セレクターを回して、設定したいメニューを選ぶ。

4 **STRAIGHT** キーを繰り返し押して、設定したい項目を選ぶ。

5 **MASTER ON/OFF** スイッチを押して本機の電源をオフにし、変更した設定を保存する。



変更した設定は、次回電源を入れたときから有効になります。

■ **リモコンセンサー設定** REMOTE SENSOR
リモコンでの本体操作を有効にするか無効にするかを設定します。

選択項目	説明
ON	リモコンの操作を有効にします。本機をリモコンで操作できます。通常はこの設定でお使いください。
OFF	リモコンの操作を無効にします。本機をリモコンで操作できません。

ご注意

通常は「ON」に設定することをおすすめします。

■ RS-232C 通信設定

RS-232C STANDBY

本機がスタンバイのときに、RS-232C 端子からのデータを受信するか、受信しないかを設定します。

選択項目	説明
YES	RS-232C 端子からのデータを受信します。
NO	RS-232C 端子からのデータを受信しません。

■ リモコン ID 設定

REMOTE CON AMP

本体操作用のリモコン ID をリモコンの操作用コードに合わせて変更します。

選択項目	説明
ID1	リモコンの操作用コードを「ID1」に設定しているときに選びます。
ID2	リモコンの操作用コードを「ID2」に設定しているときに選びます。

リモコンの操作用コードを設定する

リモコンの操作用コードを設定します。複数のヤマハ製アンプをリモコンを使って操作する場合に、本機とは別のアンプが動作するのを防止します。

本機の設定を変更する (ADVANCED SETUP)

ボールペンなどで ⑩ID ボタンを押して ID を切り替える。

⑩ID ボタンを押すごとに、ID インジケーターが以下のように表示されます。

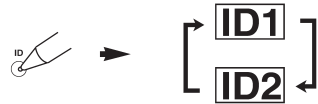

■ バイアンプ設定 BI-AMP

バイアンプ機能を設定します。

選択項目	説明
ON	バイアンプ機能をオンにします。
OFF	バイアンプ機能をオフにします。

ご注意

「BI-AMP」を「ON」に設定すると SURROUND BACK 端子はバイアンプ用として使われるので、サラウンドボックススピーカー接続用としては使えません。

■ 初期設定に戻す INITIALIZE

変更した設定を初期設定に戻します。初期設定に戻す項目を選んでください。

選択項目	説明
DSP PARAM	すべての音場プログラムパラメーターを初期設定に戻します。
VIDEO	すべての「VIDEO MENU」の設定、および「DISPLAY SET」の「OSD SHIFT」、「GRAY BACK」を初期設定に戻します。
ALL	本機のすべての設定を初期設定に戻します。
CANCEL	初期設定に戻しません。



音場プログラムごとに音場パラメーターを初期設定に戻すには、音場パラメーター「INITIALIZE」で設定してください。

■ HDMI モニターチェック設定

MONITOR CHECK

本機のモニターチェック機能のオン、オフを設定します。

選択項目	説明
YES	HDMI 接続したモニターが対応している解像度の情報を自動的にチェックします。「HDMI RES.」で、モニターが対応している解像度のみ選べます。
SKIP	「HDMI RES.」のすべての解像度を選べます。

すべての設定を初期設定に戻す

変更したセットメニューの設定や音場パラメーター、プリセットした FM / AM 放送局などをすべて初期設定に戻します。

ご注意

- セットメニューを含む本機のすべての設定が初期化されます。
- 変更した設定は、次回電源を入れたときから有効になります。



初期化操作を中止するにはフロントパネルの **MASTER ON/OFF** スイッチを押して本機の電源をオフにしてください。

- 1 **MASTER ON/OFF** スイッチを押して本機の電源をオフにする。

- 2 **STRAIGHT** キーを押しながら **MASTER ON/OFF** スイッチを押して本機の電源をオンにする。

本機の電源がオンになり、フロントパネルディスプレイにアドバンスセットアップメニューが表示されます。



- 3 **PROGRAM** セレクターを回して「INITIALIZE」を選ぶ。



- 4 **STRAIGHT** キーを繰り返し押し「ALL」を選ぶ。

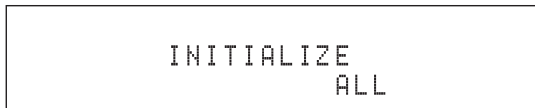

初期設定に戻さない場合は「CANCEL」を選んでください。

- 5 **MASTER ON/OFF** スイッチを押して本機の電源をオフにする。
すべての設定が初期設定に戻ります。

MEMO

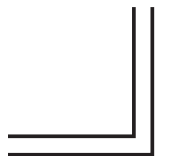
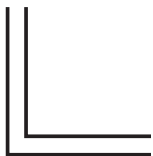
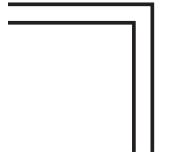

RX-V1900/HTR-6290/ DSP-AX1900

